



McIntosh Laboratory, Inc. 2 Chambers Street Binghamton, New York 13903-2699 Phone: 607-723-3512 www.mcintoshlabs.com

C22 60th Anniversary
Stereophonic Preamplifier
Owner's Manual





The lightning flash with arrowhead, within an equilateral triangle, is intended to alert the user to the presence of uninsulated "dangerous voltage" within the product's enclosure that may be of sufficient magnitude to constitute a risk of electric shock to persons.

WARNING - TO REDUCE RISK OF FIRE OR ELECTRICAL SHOCK, DO NOT EXPOSE THIS EQUIPMENT TO RAIN OR MOISTURE.



AVIS RISQUE DE CHOC ELECTRIQUE - NE PAS OUVRIR.

NO USER-SERVICEABLE PARTS INSIDE. REFER SERVICING TO QUALIFIED PERSONNEL.

The exclamation point within an equilateral triangle is intended to alert the user to the presence of important operating and maintenance (servicing) instructions in the literature accompanying the appliance.

To prevent the risk of electric shock, do not remove cover or back. No user-serviceable parts inside.

IMPORTANT SAFETY INSTRUCTIONS!

PLEASE READ THEM BEFORE OPERATING THIS EQUIPMENT.

1. Read these instructions.
2. Keep these instructions.
3. Heed all warnings.
4. Follow all instructions.
5. Do not use this apparatus near water.
6. Clean only with a dry cloth.
7. Do not block any ventilation openings. Install in accordance with the manufacturer's instructions.
8. Do not install near any heat sources such as radiators, heat registers, stoves, or other apparatus (including amplifiers) that produce heat.
9. Do not defeat the safety purpose of the polarized or grounding-type plug. A polarized plug has two blades with one wider than the other. A grounding type plug has two blades and a

third grounding prong. The wide blade or the third prong are provided for your safety. If the provided plug does not fit into your outlet, consult an electrician for replacement of the obsolete outlet.

10. Protect the power cord from being walked on or pinched particularly at plugs, convenience receptacles, and the point where they exit from the apparatus.
11. Only use attachments/accessories specified by the manufacturer.
12. Use only with the cart, stand, tripod, bracket, or table specified by the manufacturer, or sold with the apparatus. When a cart is used, use caution when moving the cart/apparatus combination to avoid injury from tip-over.
13. Unplug this apparatus during lightning storms or when unused for long periods of time.
14. Refer all servicing to qualified service personnel. Servicing is required when the apparatus has been damaged in any way, such as power-



supply cord or plug is damaged, liquid has been spilled or objects have fallen into the apparatus, the apparatus has been exposed to rain or moisture, does not operate normally, or has been dropped.

15. Do not expose this equipment to dripping or splashing and ensure that no objects filled with liquids, such as vases, are placed on the equipment.
16. To completely disconnect this equipment from the a.c. mains, disconnect the power supply cord plug from the a.c. receptacle.
17. The mains plug of the power supply cord shall remain readily operable.
18. Do not expose batteries to excessive heat such as sunshine, fire or the like.
19. Connect mains power supply cord only to a mains socket outlet with a protective earthing connection.

Thank You

Your decision to own this McIntosh C22 Stereophonic Preamplifier ranks you at the very top among discriminating music listeners. You now have "The Best." The McIntosh dedication to "Quality," is assurance that you will receive many years of musical enjoyment from this unit.

Please take a short time to read the information in this manual. We want you to be as familiar as possible with all the features and functions of your new McIntosh.

Please Take A Moment

The serial number, purchase date and McIntosh Dealer name are important to you for possible insurance claim or future service. The spaces below have been provided for you to record that information:

Serial Number: _____

Purchase Date: _____

Dealer Name: _____

Technical Assistance

If at any time you have questions about your McIntosh product, contact your McIntosh Dealer who is familiar with your McIntosh equipment and any other brands that may be part of your system. If you or your Dealer wish additional help concerning a suspected problem, you can receive technical assistance for all McIntosh products at:

McIntosh Laboratory, Inc.
2 Chambers Street
Binghamton, New York 13903
Phone: 607-723-1545
Fax: 607-724-0549

Customer Service



If it is determined that your McIntosh product is in need of repair, you can return it to your Dealer. You can also return it to the McIntosh Laboratory Service Department. For assistance on factory repair return procedure, contact the McIntosh Service Department at:

McIntosh Laboratory, Inc.
2 Chambers Street
Binghamton, New York 13903
Phone: 607-723-3515
Fax: 607-723-1917

Table of Contents

Safety Instructions	2
Thank You and Please Take a Moment.....	3
Technical Assistance and Customer Service	3
Table of Contents	3
General Information	3
Connector and Cable Information	4
Introduction.....	4
Performance Features	4
Dimensions	5
Installation	6
Rear Panel Connections	7
How to Connect the C22	8
Connection Diagrams (Separate Sheets).... Mc1A and Mc1B	
How to use the Remote Control.....	9
Front Panel Displays, Controls, Switches and Jack.....	10
How to Operate the C22	11
Specifications.....	14
Packing Instruction.....	15

General Information

1. The C22 uses Vacuum Tubes for amplifying the audio signal. The C22 is designed to have only qualified Service Personnel perform any part(s) replacement including all the vacuum tubes.
2. For additional connection information, refer to the owner's manual(s) for any component(s) connected to the C22 Stereophonic Preamplifier.
3. The Main AC Power going to the C22 and any other McIntosh Component(s) should not be applied until all the system components are connected together. Failure to do so could result in malfunctioning of some or all of the system's normal operations. When the C22 and other McIntosh Components are in their Standby Power Off Mode, the Microprocessor's Circuitry inside each component is active and communication is occurring between them.
4. Up to two Sensors can be wired in parallel for Remote Control of the C22 from other rooms.
5. Balanced and Unbalanced Inputs and Outputs can be mixed. For example, you may connect signal sources to Unbalanced Inputs and send signals from the Balanced Outputs. You can also use Balanced and Unbalanced Outputs simultaneously, connected to different Power Amplifiers.
6. When discarding the unit, comply with local rules or regulations. Batteries should never be thrown away or incinerated but disposed of in accordance with the local regulations concerning battery disposal. 
7. For additional information on the C22 and other McIntosh Products please visit the McIntosh Web Site at www.mcintoshlabs.com. 



Connector and Cable Information

XLR Connectors

Below is the Pin configuration for the XLR Balanced Input and Output Connectors on the C22. Refer to the diagrams for connections:

- PIN 1: Shield/Ground
- PIN 2: + Signal
- PIN 3: - Signal

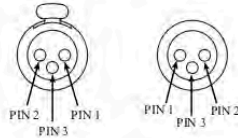

Power Control Connectors

The C22 Power Control Output Jacks send Power On/Off Signals when connected to McIntosh Components. A 1/8 inch stereo mini phone plug is used for connection to the Power Control Outputs on the C22.

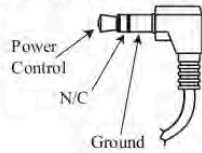

*Note: The Data, Power Control Connecting Cable is available from the McIntosh Parts Department: **Data and Power Control Cable Part No. 170-202** Six foot, shielded 2 conductor, with 1/8 inch stereo mini phone plugs on each end.*

Data Port Connectors

The C22 Data Out Ports send Remote Control Signals to McIntosh Source Components. A 1/8 inch stereo mini phone plug is used for connection.

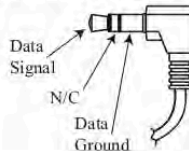

Introduction

The McIntosh C22 Stereophonic Preamplifier is one of the finest Tube Preamplifiers ever created. The versatile Preamplifier provides connections for various input sources and outputs to drive multiple Power Amplifiers. The C22 reproduction is sonically transparent and absolutely accurate. The McIntosh Sound is "The Sound of the Music Itself."

Performance Features

• Electromagnetic Input Switching

Digital Logic integrated circuits drive Electromagnetic Switches on all Inputs and operating functions for reliable, noiseless, distortion free switching. There is also a Record Monitor function for checking the progress of a recording.

• Moving Coil and Moving Magnet Phono Inputs

The C22 contains two different precision Phono Preamplifier Circuits. One for low output Moving Coil Phono Cartridges with selectable resistance loading, the other is for Moving Magnet Cartridges with selectable capacitive loading. Both circuits use the latest designs to provide the lowest possible noise and distortion. The RIAA Equalization Circuitry utilizes close tolerance resistors and capacitors for an extremely flat frequency response.

• Balanced Inputs

The Balanced Inputs allow the connection of a source component using long cable lengths without a loss in sound quality.

• Low Distortion

Distortion levels of all types are less than 0.08%. Music is amplified with total transparency and accuracy.

• Tone Controls with Bypass

The C22 allows for bypassing the Bass and Treble Tone Circuitry.

• Output Switching

Front panel Output Push-buttons control two Switched Outputs that allow sending signals to two separate Power Amplifiers.

• Remote Control with External Sensor Input

The Remote Control provides basic control of the C22 operating functions and any McIntosh Source Components connected to it. Enjoy your McIntosh System from another room in your home by connecting external sensors.

• Power Control Output

A Power Control connection for convenient Turn-On of McIntosh Power Amplifiers, Source Components and Accessories is included.

• Precision Parts

Only the finest precision 1% tolerance resistors are used throughout.

• Special Power Supply

Fully regulated Power Supplies and a special R-Core Power Transformer ensure stable noise free operation even though the power line varies.

• Extruded Side Panels

The sides of the C22 are extruded aluminum panels with a bead blast textured surface and a black anodized finish.

• Solid State Front Panel Illumination

The Illumination of the Front Panel is accomplished by extra long life Light Emitting Diodes (LEDs).

Dimensions

The following dimensions can assist in determining the best location for your C22.

Front View of the C22

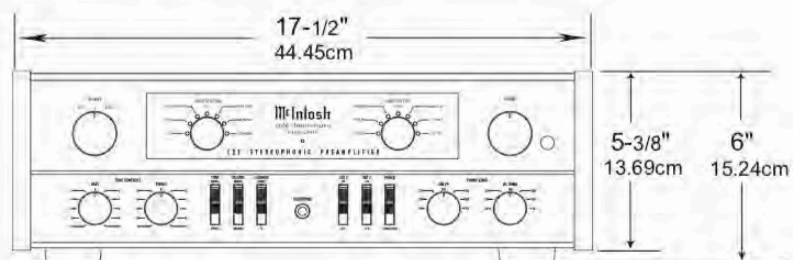

Rear View of the C22

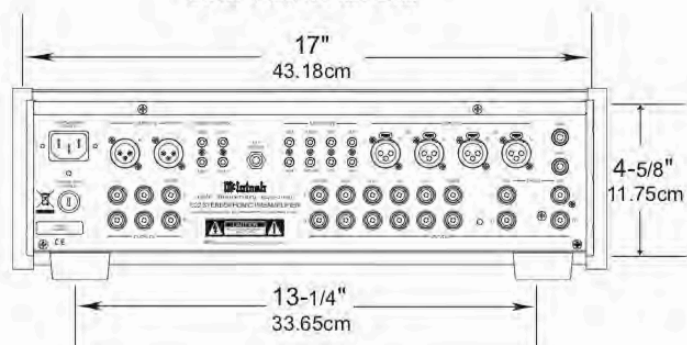

Side View of the C22

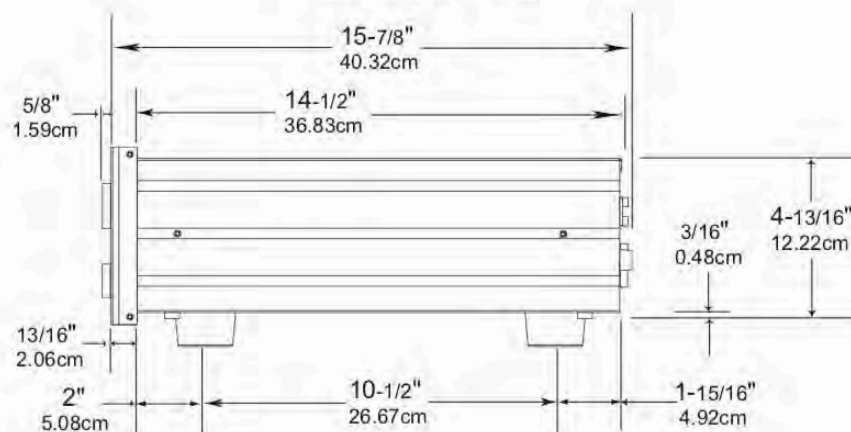



Installation

The C22 can be placed upright on a table or shelf, standing on its four feet. It also can be custom installed in a piece of furniture or cabinet of your choice. The four feet may be removed from the bottom of the C22 when it is custom installed as outlined below. The four feet together with the mounting screws should be retained for possible future use if the C22 is removed from the custom installation and used free standing. The required panel cutout, ventilation cutout and unit dimensions are shown.

Always provide adequate ventilation for your C22. Cool operation ensures the longest possible operating life for any electronic instrument. Do not install the C22 directly above a heat generating component such as a high powered amplifier. If all the components are installed in a single cabinet, a quiet running ventilation fan can be a definite asset in maintaining all the system components at the coolest possible operating temperature.

A custom cabinet installation should provide the following minimum spacing dimensions for cool operation.

Allow at least 6 inches (15.24cm) above the top, 2 inches (5.08cm) below the bottom and 1 inch (2.54cm) on each side of the Tube Preamplifier, so that airflow is not obstructed. Allow 19-1/2 inches (49.53cm) depth behind the front panel. Allow 1-1/8 inch (2.9cm) in front of the mounting panel for knob clearance. Be sure to cut out a ventilation hole in the mounting shelf according to the dimensions in the drawing.

**C22 Front Panel
Custom Cabinet Cutout**

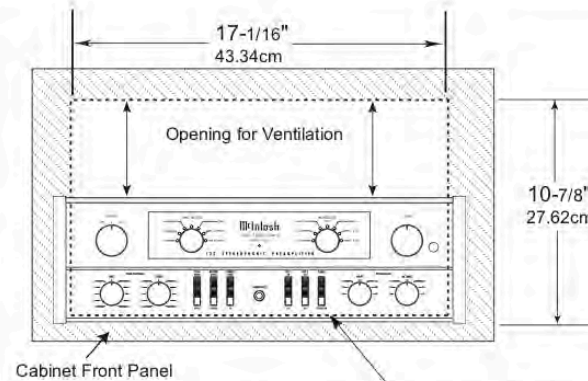

**C22 Side View
in Custom Cabinet**

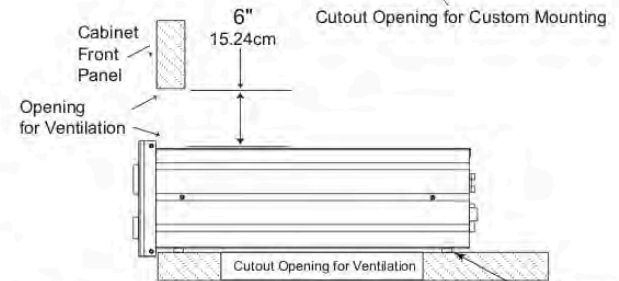

**C22 Bottom View
in Custom Cabinet**

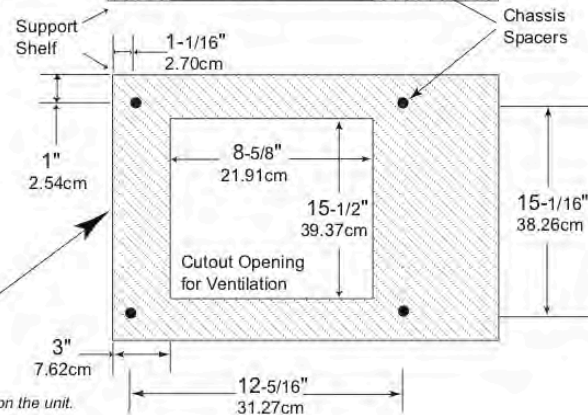

Note: Center the cutout horizontally on the unit. For purposes of clarity, the above illustration is not drawn to scale.

Rear Panel Connections

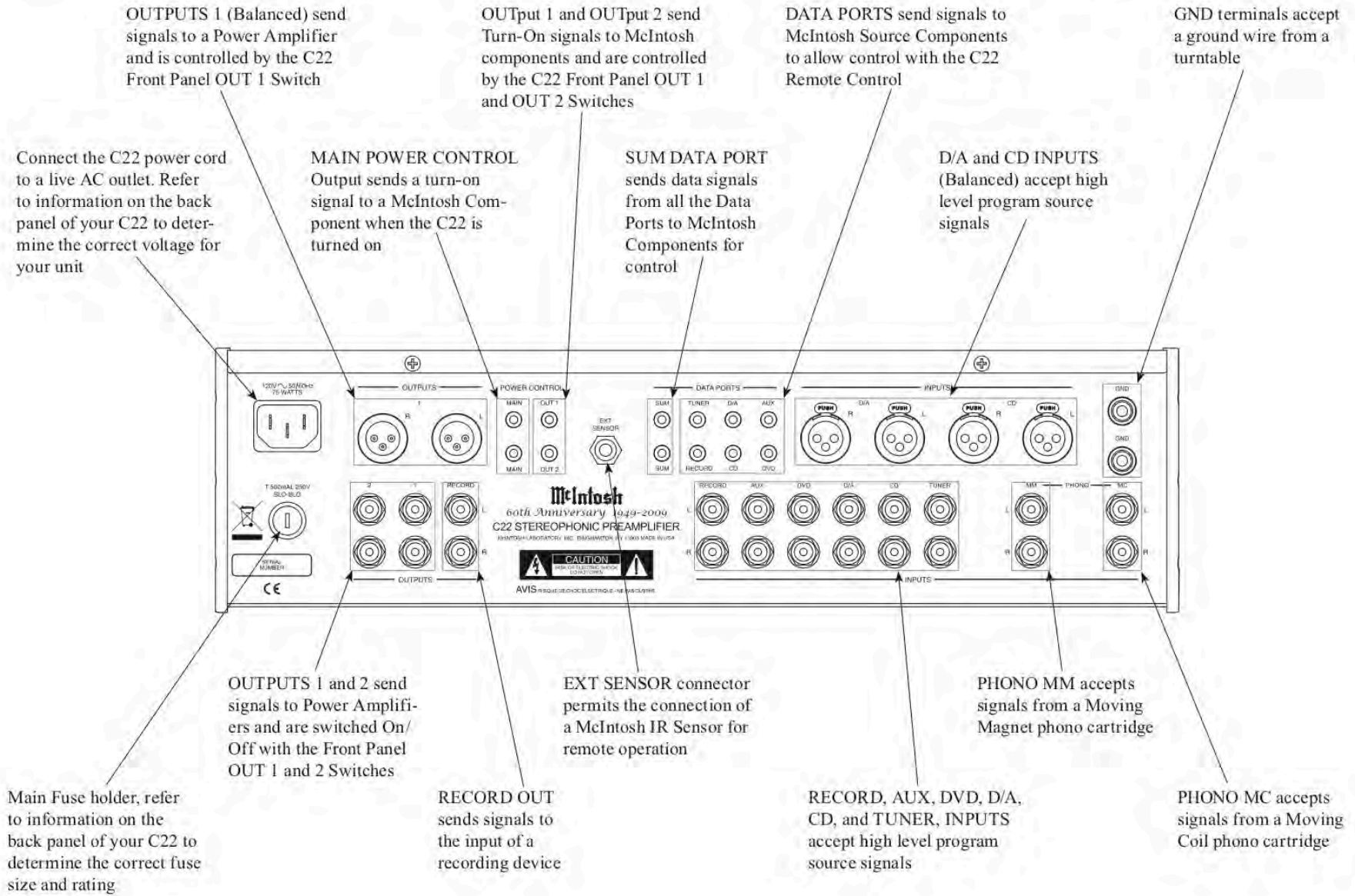



How to Connect the C22

The C22 has the ability to automatically switch power On/Off to McIntosh Source Components via the Power Control connections. The Data Port Connections allow for the remote operation of basic functions using the C22 Remote Control. With an external sensor connected to the C22, remote control operation of the system is possible from another room and/or when the C22 is located in a cabinet with the doors closed.

The connection instructions below, together with the C22 Input and Output Connection Diagrams located on the separate folded sheet “**Mc1A/1B**”, are an example of a typical audio system. Your system may vary from this, however the actual components would be connected in a similar manner. For additional information refer to “Connector and Cable Information” on page 4.

Power Control Connections:

1. Connect a Control Cable from the C22 POWER CONTROL MAIN (lower) Jack to the Power Control In on the AM/FM Tuner.
3. Connect a Control Cable from the AM/FM Tuner Power Control Out Jack to the SACD/CD Player Power Control In Jack.
4. Connect a Control Cable from the SACD/CD Player Power Control Out Jack to the Turntable Power Control Remote In Jack.
5. Connect a Control Cable from the Turntable Power Control Remote Out Jack to the Music Server Power (PWR) Control (CTRL) In Jack.
6. Connect a Control Cable from the C22 POWER CONTROL MAIN (upper Jack) to the Power Amplifier (right) Power Control In Jack. Connect a Control Cable from the Power Amplifier (right) Power Control Out Jack to the Power Amplifier (left) Power Control In Jack.

7. Optionally connect a Control Cable from the C22 POWER CONTROL OUT 2 Jack to the Stereo Power Amplifier (Secondary Room) Power Control In Jack.
8. Connect any additional McIntosh Components in a similar manner, as outlined in steps 1 thru 4.

Data Control Connections:

9. Connect a Control Cable from the C22 TUNER DATA PORTS Jack to the AM/FM Tuner Data In Tuner 1 Jack.
10. Connect a Control Cable from the C22 CD DATA PORT Jack to the SACD/CD Player Data In Jack.
11. Connect a Control Cable from the C22 RECORD DATA PORT Jack to the Music Server Data In Jack.
12. Connect any additional McIntosh Components in a similar manner, as outlined in steps 9 thru 11.

Sensor Connections:

13. Connect a RG59U or RG6U Cable from the C22 EXT (external) SENSOR “F” Connector to the Sensor “F” Connector.

Audio Connections:

14. Connect an Audio Cable from the C22 TUNER INPUT Jacks to the AM/FM Tuner, Tuner 1 Fixed Output Jacks.
15. Connect Balanced Cables from the C22 CD INPUT Jacks to the SACD/CD Player Fixed Balanced Output Jacks.
Note: Unbalanced Audio Cables may be used instead of the Balanced Cables, but not both.
16. Connect an Audio Cable from the C22 RECORD INPUT Jacks to the Music Server Output Jacks.
17. Connect an Audio Cable from the C22 RECORD OUTPUT Jacks to the Music Server Input 3 Jacks.
18. Connect the Audio Cables coming from the Turn-

table to the C22 MC PHONO INPUT Jacks.

Note: If the Turntable has a Moving Magnet Cartridge, connect the audio cables to the C22 MM PHONO INPUT instead of the MC Input.

19. Connect Balanced Cables from the C22 OUTPUTS 1 L and R Jacks to the Power Amplifiers (Main Left and Right) Balanced Input Jacks.
20. Optionally, connect an Audio Cable from the C22 OUTPUT 2 Jacks to the McIntosh Power Amplifier (Secondary) Input Jacks.
21. Connect any additional McIntosh Components in a similar manner, as outlined in steps 14 thru 20.

Ground Connections:

22. Connect the Ground Cable coming from the Turntable to the C22 GND Binding Post.

AC Power Cords Connections:

23. Connect the C22 AC Power Cord to a live AC outlet as illustrated.

How to use the Remote Control

The supplied Remote Control is capable of directly controlling the functions of contemporary McIntosh Source Components connected to the C22 Tube Pre-amplifier.

Power

To Switch the C22 ON or OFF press the POWER Push-button on the Remote Control.

Note: During the Tube Warm Up time (when first switched ON), the Front Panel INPUT and MODE SELECTOR LEDs will flash and the Audio Outputs will be muted.

Input Source Selection

Press the INPUT Up▲ or Down▼ Push-button to select the desired program source.

Disc, Server and Tape Functions

Use the PLAY, STOP, NEXT, BACK and PAUSE Push-buttons to operate a DVD Player, CD Player, CD Changer, Music Server or Tape Recorder.

- Notes:*
1. For Remote Control Operation of a Source Component using the C22 Remote Control, a connection is required between the appropriate C22 Data Port and the Source Component Data Port. Refer to pages 4 and 8 for additional information.
 2. Refer to the Source Component's Owner's Manual for specific operating information.

Volume

Press the Up▲ or Down▼ VOLUME Push-button to raise or lower the listening volume level.

Note: The Record Signals present at RECORDER OUTPUTS are not affected by volume changes.

Press to Power the C22 ON or OFF

Adjusts the volume level up or down

Scrolls through the available C22 Inputs

Selects Disc Player, Music Server or Tape Recorder Functions and also performs various functions on a variety of McIntosh Components

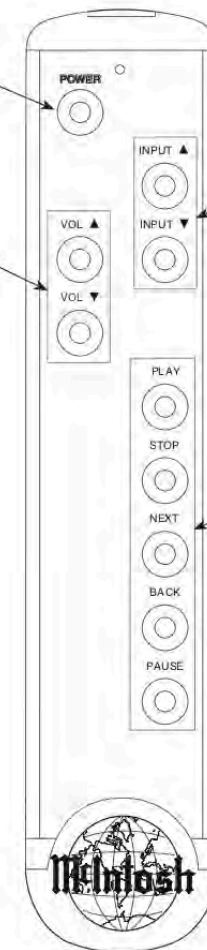



Front Panel Displays, Controls, Switches and Jack

BALANCE Control allows the adjustment of the relative volume balance between channels

Indicates when the C22 is connected to an active AC Outlet

VOLUME Control adjusts the listening level for both channels

INPUT SELECTOR Control selects the desired audio signals for listening and recording

MODE SELECTOR allows for listening to various channel combinations from Stereo to Mono

IR Sensor receives commands from a Remote Control

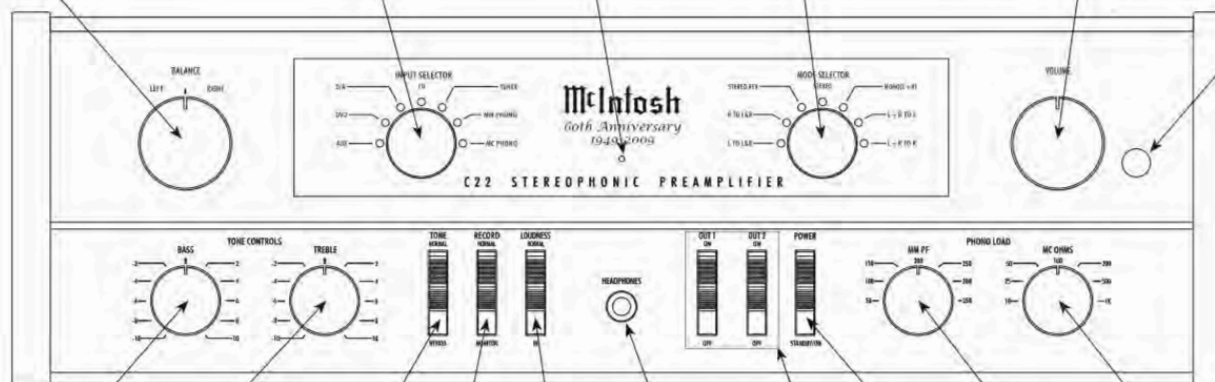

TREBLE Control provides 10dB boost or cut with a center flat position

REC MONITOR allows listening to the playback of RECORD Source while the recording is in process

Connection for low impedance dynamic headphones with 1/4" (6.3mm) stereo phone type plug, for private listening

POWER Switch, switches the C22 ON or STAND/BY(Off)

PHONO LOAD MC OHMS provides seven different resistive loads for a Moving Coil Phono Cartridge

BASS Control provides 10dB boost or cut with a center flat position

TONE BYPASS when activated the audio signal bypasses the Tone Controls

LOUDNESS switch provides frequency response contoured to compensate for the sensitivity of the human ear at softer listening levels

OUTPUTS 1 and 2 switches allow the C22 to switch Power Control and Audio to two separate Power Amplifiers

PHONO LOAD MM PF provides seven different capacitive loads for a Moving Magnet Phono Cartridge

How to Operate

Power On

The Red LED located under the “1949-2009” nomenclature on the Front Panel lights to indicate the C22 is connected to an active AC Outlet. To Switch ON the C22, momentarily press downward the POWER Rocker Switch on the Front Panel or the POWER Push-button on the Remote Control. During the Tube Warm Up time (when first switched ON), the Front Panel INPUT and MODE SELECTOR LEDs will flash and the Audio Outputs will be muted. Refer to illustration on the previous page and figure 1 on this page.

Source Selection

Select the desired source using the INPUT SELECTOR Control on the Front Panel or press the INPUT ▲ or ▼ on the Remote Control.

Volume Control

Rotate the Front Panel VOLUME Control or use the VOLume ▲ (Up) or ▼ (Down) Push-buttons on the Remote Control for the desired listening level.

Loudness Compensation

To activate the Loudness Compensation Circuitry place the LOUDNESS Rocker Switch in the IN Position on the Front Panel. When active, the Loudness Compensation Circuitry works in conjunction with the rotational position of the Volume Control. It compensates for the sensitivity of the human ear at softer listening levels by boosting the volume level of the low frequencies relative to the midrange frequencies to provide a fuller sound.

Balance Control

Rotate the Front Panel BALANCE Control as needed to achieve approximately equal listening volume levels

in each Loudspeaker. Rotate the BALANCE counterclockwise to emphasize the Left Channel by reducing the level of the Right Channel. Rotate the BALANCE clockwise to emphasize the Right Channel by reducing the level of the Left Channel.

Mode Selector

The Front Panel MODE SELECTOR Control allows the Left and Right Input Signals from the desired source to be combined into various different outputs sent to the Loudspeakers and Headphones. Refer to the chart below:

Mode Selection	Output Channels	
	LEFT	RIGHT
STEREO	Left Input Signal	Right Input Signal
STEREO REV	Right Input Signal	Left Input Signal
MONO	Left + Right Input Signals	Left + Right Input Signals
L to L&R	Left Input Signal	Left Input Signal
R to L&R	Right Input Signal	Right Input Signal
L+R to L	Left +Right Input Signals	-
L+R to R	-	Left+ Right Input Signals

Bass Control

Rotate the BASS clockwise from the center (12 o'clock) position to emphasize the low frequency content of the music. Likewise rotate the BASS counterclockwise from the center position to de-emphasize the low frequency content of the music.

Treble Control

Rotate the TREBLE clockwise from the center (12 o'clock) position to emphasize the high frequency content of the music. Likewise rotate the TREBLE counterclockwise from the center position to de-em-

phasize the high frequency content of the music.

Tone Bypass Switch

When the TONE Switch on the Front Panel is placed in the BYPASS position the Tone Controls together with the Tone Circuitry is totally bypassed for a flat response.

Record Monitor

To activate the Record Monitor Circuit place the RECORD Rocker Switch in the MONITOR Position on the Front Panel. When active, the sound coming from Record Source Component will be heard. Some Recording Components allow for listening to the Playback Signal a fraction of a second after the recording has taken place.

Output 1 and 2

To switch Off the audio signal going to the Power Amplifiers connected to the C22 Preamplifier Outputs, place the OUTput 1 and/or the OUTput 2 Rocker Switch in the OFF Position on the Front Panel. When there is a Power Control Connection between the C22 Power Control OUT 1 or OUT 2 and the Power Amplifier(s), the Power Amplifier(s) will be switched Off.

Phono Load Adjustments

There are Phono Load Adjustments for both types of Phono Cartridges, Moving Coil (MC) and Moving



Figure 1



How to Operate, con't

Magnet (MM). The resistive load for the MC Input is selectable from 10 ohms to 1,000 ohms. The capacitive load for the MM Input is selectable from 50 picofarads to 350 picofarads.

Select the Phono Load setting using the Front Panel MC or MM Control for the cartridge type connected to the C22. Choose the value closest to the recommended load value specified by the Phono Cartridge Manufacturer.

Headphones Jack

Connect a pair of dynamic headphones with a 1/4" (6.3mm) stereo phone type plug to the Headphones Jack for private listening.

How To Make A Recording

1. Use the Input Selector to choose the desired Source Input Signal you wish to record. Refer to figure 2.
2. Adjust the record level using the recorder volume control and proceed with the recording process.

3. To listen to the playback of the program source just recorded, place the RECORD switch on the front panel to the MONITOR position. The Front Panel INPUT SELECTOR LED will flash indicating the Input Source selected for recording. During the time the RECORD Switch is in the MONITOR position Source Selection is not possible, either by using the Front Panel INPUT SELECTOR or Remote Control INPUT Up▲ or Down▼ push-buttons. Refer to figures 2 and 3.

Note: The C22 RECORD OUTPUT Signals are not affected by the setting of VOLUME or BALANCE Controls.

Reset of Microprocessors

In the unlikely event the controls of the C22 stop functioning, the microprocessors can be reset by placing the Front Panel POWER Switch in the STANDBY/ON position and holding it in for fifteen seconds and then releasing the switch.

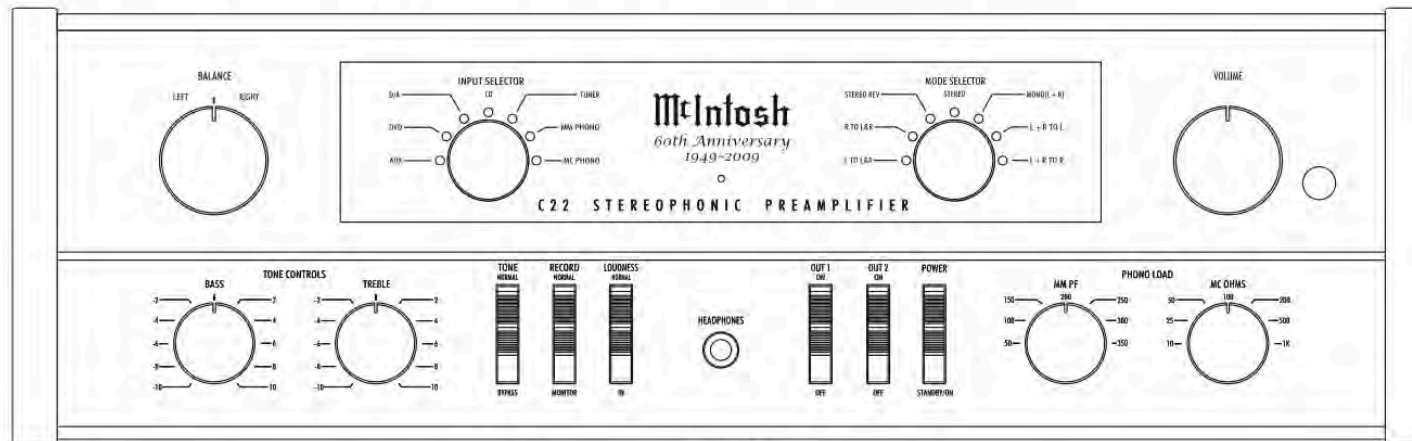

Figure 2

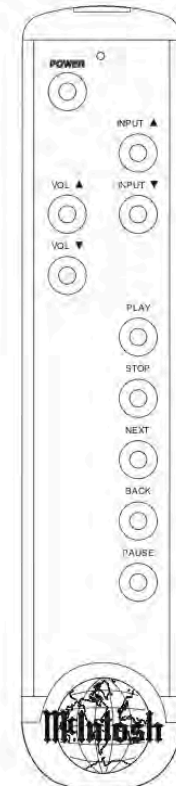

Figure 3



Specifications

Frequency Response

+0, -0.5dB from 20Hz to 20,000Hz
+0, -1dB from 10Hz to 100,000Hz

Total Harmonic Distortion

0.08% from 20Hz to 20,000Hz

Rated Output (Output 1 and 2)

2.5V Unbalanced, 5V Balanced

Maximum Voltage Output

8V RMS Unbalanced, 16V RMS Balanced

Sensitivity (for rated output)

High Level, 450mV unbalanced, 900mV balanced
Phono MM, 4.5mV
Phono MC, 0.45mV

Signal To Noise Ratio (A-Weighted)

High Level, 98dB
Phono, 80dB

Input Impedance

High Level, 20K ohms unbalanced, 20k ohms balanced
Phono MM, 47K ohms; 50 to 350pF, in 50pF steps
Phono MC, 10, 25, 50, 100, 200, 500 or 1,000 ohms;
100pF

Maximum Input Signal

High Level, 5V Unbalanced, 10V Balanced
Phono MM, 50mV
Phono MC, 5mV

Voltage Gain

High Level to Record Output: 0dB
High Level to Output 1 and 2: 15dB
Phono MM to Record Output: 40dB
Phono MC to Record Output: 60dB

Output Impedance

220 ohms

Headphone Load Impedance

16 ohms to 250 ohms

Tube Compliment

High Level Circuitry: 2 - 12AX7A
MM Phono Circuitry: 2 - 12AX7A
MC Phono Circuitry: 2 - 12AX7A

Power Requirements

100V ~ 50/60Hz at 75 watts
110V ~ 50/60Hz at 75 watts
120V ~ 50/60Hz at 75 watts
220V ~ 50/60Hz at 75 watts
230V ~ 50/60Hz at 75 watts
240V ~ 50/60Hz at 75 watts
Standby, less than 2 watts

Note: Refer to the rear panel of the C22 for the correct voltage.

Overall Dimensions

Width is 17-1/2 inches (44.45cm)
Height is 6 inches (15.24cm) including feet
Depth is 18 inches (45.72cm) including the Front Panel, Knobs and Cables

Weight

27 pounds (12.25 kg) net, 43.4 pounds (19.68 kg) in shipping carton

Shipping Carton Dimensions

Width is 26-1/2 inches (67.3cm)
Depth is 24-1/4 inches (61.6cm)
Height is 11-3/4 inches (29.9cm)

Packing Instructions

In the event it is necessary to repack the equipment for shipment, the equipment must be packed exactly as shown below. It is very important that the four plastic feet are attached to the bottom of the equipment. This will ensure the proper equipment location on the bottom pad. Failure to do this will result in shipping damage.

Use the original shipping carton and interior parts only if they are all in good serviceable condition. If a shipping carton or any of the interior part(s) are needed, please call or write Customer Service Department of McIntosh Laboratory. Refer to page 4. Please see the Part List for the correct part numbers.

Quantity	Part Number	Description
1	033838	Shipping carton only
4	033837	End cap
1	033836	Inside carton only
1	033725	Top pad
1	034301	Bottom pad
2	034446	Foam plug
4	017937	Plastic foot
4	400159	#10-32 x 3/4" screw
4	404080	#10 Flat washer

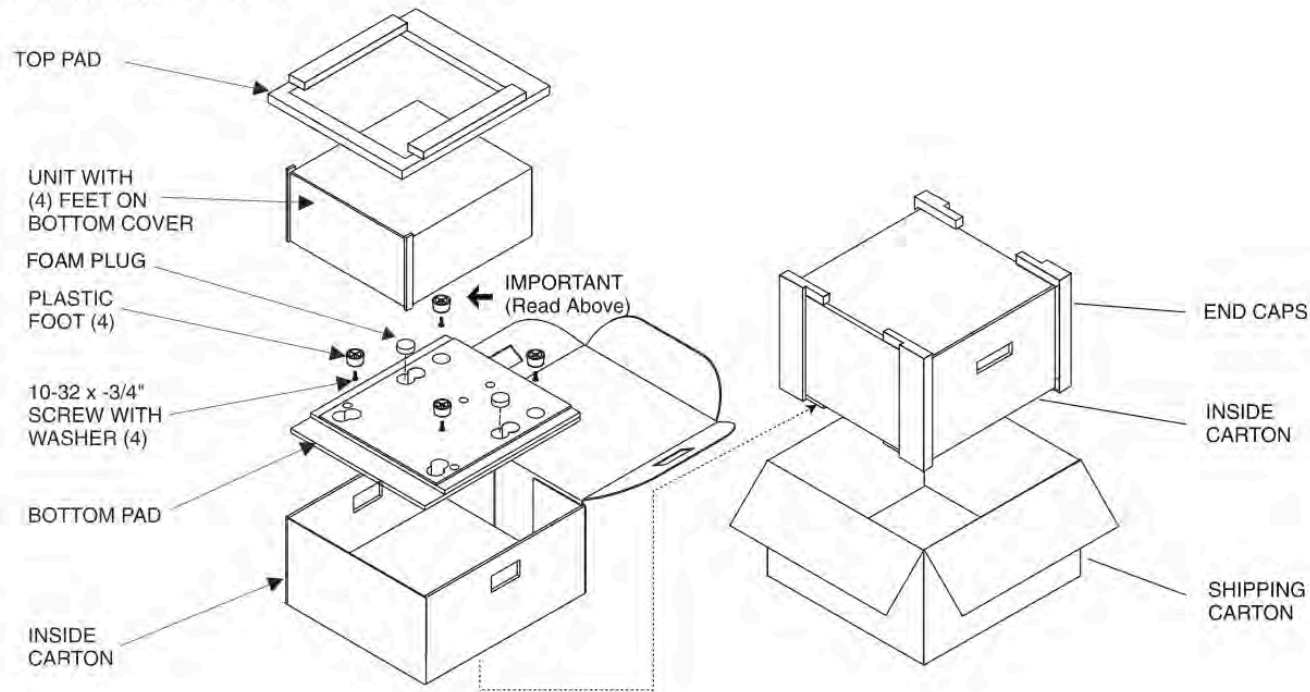



McIntosh Laboratory, Inc.
2 Chambers Street
Binghamton, NY 13903
www.mcintoshlabs.com

The continuous improvement of its products is the policy of McIntosh Laboratory Incorporated who reserve the right to improve design without notice.
Printed in the U.S.A.

McIntosh Part No. 04112100