

**MAC 4200**  
RECEIVER

**McIntosh<sup>®</sup>**

OWNERS MANUAL

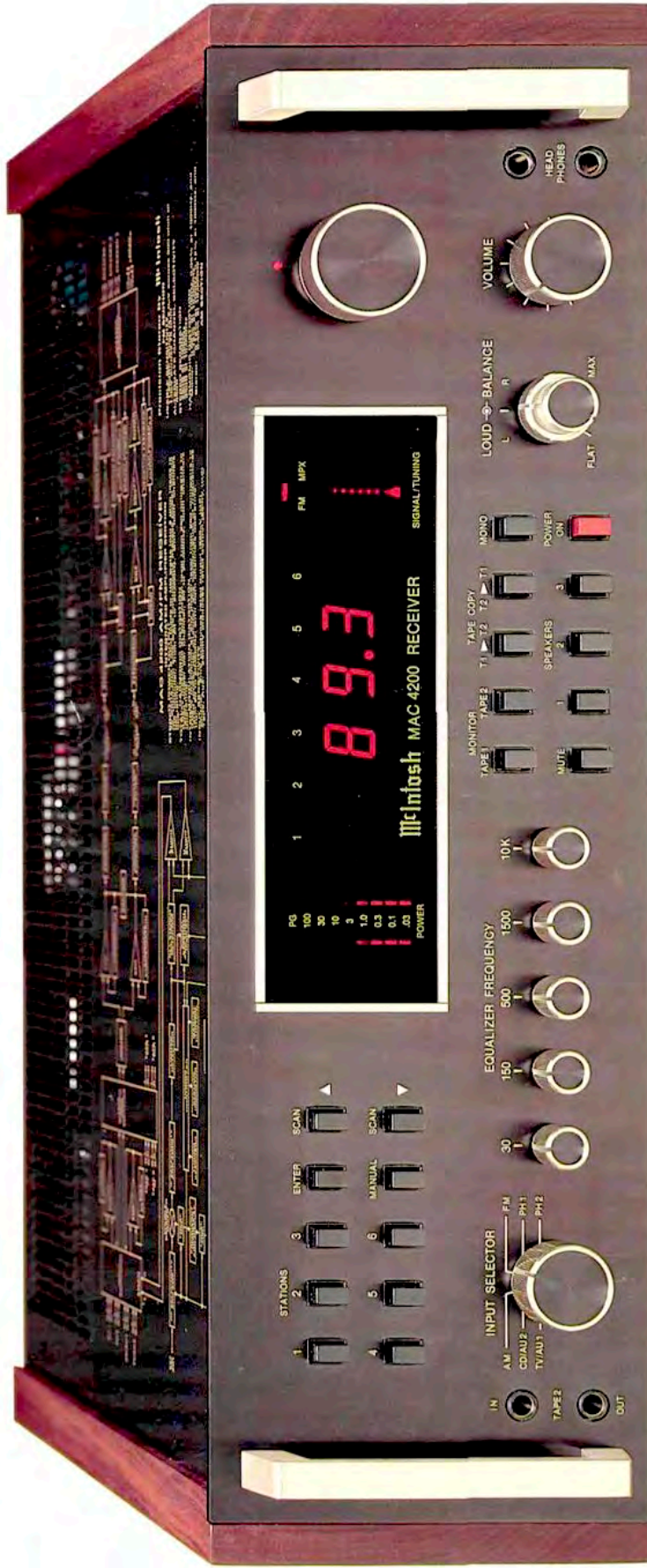

PG 100 30 10 3  
1.0 0.3 0.1 0.05  
POWER

1 2 3 4 5 6

89.3

FM MPX

McIntosh MAC 4200 RECEIVER

SIGNAL TUNING

STATIONS 1 2 3 4 5 6

ENTER SCAN

MANUAL SCAN

INPUT SELECTOR

AM CD/AU2 TV/AU1 FM PH1 PH2

EQUALIZER FREQUENCY

150 500 1000 10K

MONITOR TAPES TAPES COPY

MUTE 1 2 3

SPEAKERS

MONO T1 T2 T3

LOUDNESS BALANCE

L R

FLAT MAX

VOLUME

HEAD PHONES

IN TAP/2 OUT

VARIOUS REGULATORY AGENCIES  
REQUIRE THAT WE BRING THE  
FOLLOWING INFORMATION TO YOUR  
ATTENTION. PLEASE READ IT CAREFULLY.

WARNING: TO PREVENT FIRE OR SHOCK  
HAZARD, DO NOT EXPOSE THIS UNIT TO RAIN  
OR MOISTURE.

CAUTION; TO PREVENT ELECTRIC SHOCK DO  
NOT USE THE POLARIZED PLUG ON THIS UNIT  
WITH AN EXTENSION CORD, RECEPTACLE OR  
OTHER OUTLET UNLESS THE BLADES CAN BE  
FULLY INSERTED TO PREVENT BLADE EXPOSURE.

The serial number, purchase date, and McIntosh  
Laboratory Service Contract number are important to you  
for possible insurance claim or future service. Record this  
information here.

Serial Number

Purchasedate

Service Contract Number

Upon application, McIntosh Laboratory provides a Service  
Contract to the original purchaser. Your McIntosh Authoriz-  
ed Service Agency can expedite repairs when you provide  
the Service Contract with the instrument for repair.

## Contents

INTRODUCTION	3
INSTALLATION	4
HOW TO CONNECT	5, 6, 7, 8
FRONT PANEL CONTROLS	9, 10, 11, 12, 13, 14, 15
PERFORMANCE LIMITS	16, 17
PERFORMANCE CHARTS	18, 19, 20
TECHNICAL DESCRIPTION	21, 22
BLOCK DIAGRAM	23
SPECTRAL FIDELITY	24

Your MAC 4200 receiver will give you many years of satisfactory performance. If you have any questions, please contact:

### CUSTOMER SERVICE

McIntosh Laboratory Inc.  
2 Chambers Street  
Binghamton, New York 13903-9990  
Phone: 607-723-3512

**Take Advantage of 3 years  
of Contract Service...  
Fill in the Application NOW!**

---

### McINTOSH THREE YEAR SERVICE CONTRACT

---

An application for A THREE YEAR SERVICE CONTRACT is included with this manual.

The terms of the contract are:

1. Your application for the SERVICE CONTRACT must be completely filled in and must be postmarked within 30 days of the date of purchase of the instrument.
2. To receive the SERVICE CONTRACT, all information on the application must be filled in. The SERVICE CONTRACT will be issued when the application is completely filled in and received by McIntosh Laboratory Incorporated in Binghamton, New York.
3. To receive the SERVICE CONTRACT, your purchase must be made from a McIntosh franchised dealer.
4. The SERVICE CONTRACT is issued to you as the original purchaser. To protect you from misrepresentation, this contract cannot be transferred to a second owner.
5. Any McIntosh authorized service agency will repair McIntosh instruments at normal service rates. To receive service under the terms of the SERVICE CONTRACT, the SERVICE CONTRACT CERTIFICATE must be presented when the instrument is taken to the service agency.
6. Always have service done by a McIntosh authorized service agency. If the instrument is modified or damaged as a result of unauthorized repair, the SERVICE CONTRACT will be cancelled. Damage by improper use or mishandling is not covered by the SERVICE CONTRACT.
7. McIntosh will provide all parts, materials and labor needed to return the measured performance of the instrument to the original performance limits. The SERVICE CONTRACT does not cover any shipping costs to and from the authorized service agency or the factory.
8. Units in operation outside the United States and Canada are not covered by the McIntosh Service Contract, irrespective of the place of purchase. Nor are units acquired outside the U.S.A. and Canada, the purchasers of which should consult with their dealer to ascertain what, if any, service contract or warranty may be available locally.

The McIntosh MAC 4200 is a high quality, FM/AM Stereo Receiver whose design has been governed by insistence on high performance with long life, great flexibility and sensitivity. The rated power output is a 75 watts per channel into 8 ohms or 100 watts per channel into 4 ohms.

You will derive the greatest enjoyment and most satisfaction when you understand its operations and its functions. Your time invested now will return added value to you because then you will get the best results from your MAC 4200.

The advanced FM/AM tuner design of the MAC 4200 displays the station frequencies digitally. The display of frequencies in the MAC 4200 serves a double function. It shows the input selected as well as the frequency to which the tuner is adjusted. Stations are selected easily either by use of the manual tuning knob, or the scan up or down feature on either band or by use of the preset feathertouch-buttons in either FM or AM.

The low noise electronic input switching system uses input leads that are very short, one twentieth of the length of other systems. This provides for reduced hum and noise, better source to source isolation (lower crosstalk), lower distortion and freedom from high power TV and radar signal interference.

The precision tracking volume control allows completely noise free performance and accuracy of the channel to channel balance over the full range. It is a step attenuator whose channel accuracy is within 1 dB throughout its entire rotation. Such extremely accurate matching is achieved through electronically controlled trimming of the resistance material deposited on pairs of printed circuits. Use does not affect performance as in ordinary volume controls.

The loudness control is continuously variable. It operates independently of the volume control, and its contour is accurately modeled after the family of "Equal Loudness" curves developed by Drs. Fletcher and Munson. Loudness controls in ordinary equipment are usually simple, passive circuits connected to a portion of the rotation range of the volume control. As a consequence, loudness compensation accuracy is dependent on many variables such as speaker efficiency, amplifier gain and differences in input level.

A five band program equalizer permits the volume adjustment of five important frequency ranges. Musical balance can be adjusted to compensate for listener preferences or recording inaccuracies. At the detent in the center of the rotation of each control the equalizer circuits are disconnected, completely removed from the operating circuits.

Front panel tape recorder jacks make playback from, or copying to, a portable recorder very convenient. The ad-

ditional tape recorder may be connected to the MAC 4200 without disconnecting your regular system.

The MAC 4200 switching circuits allow the AC power to the entire stereo system to be controlled from either the turntable's power switch or the power switch on this exceptional receiver. Connected to a special power outlet is a current sensing relay that will be energized when the turntable is turned on or when the red power switch is pushed on. The relay, in turn, controls the AC power to the rest of the stereo system.

POWER GUARD dynamically permits the power amplifier circuit in the MAC 4200 to deliver full maximum power without the music destroying sounds of hard clipping; the music you hear is protected from distortion and your speakers are protected from damage.

Electronically regulated power supplies maintain stable operation even during periods of low or changing AC power line voltage.

---

## INTRODUCTION 3

The MAC 4200 may be used on a shelf or table top in the enclosure in which it comes or may be installed in a custom cabinet. In any method of use provide adequate ventilation.

The trouble-free life of any electronic instrument is greatly extended by providing sufficient ventilation to prevent the build-up of heat that causes deterioration of component parts. Allow enough clearance so cool air can enter at the bottom of the receiver and be vented from the top and rear. The feet installed on the bottom of the receiver must be left in place when using a shelf or table top installation. The feet raise the receiver above the mounting surface to allow reasonable ventilation. If temperatures increase due to restricted ventilation or speaker mismatch, an automatic temperature sensing device turns off the MAC 4200. The device operates automatically at a preset temperature. The MAC 4200 will turn on again when the temperature has returned to normal limits. This additional feature assures complete reliability under the most extreme operating conditions.

#### INSTALLING THE MAC 4200 IN A CUSTOM CABINET

The MAC 4200 is installed from the front of a custom cabinet. The space needed behind the cabinet panel is 15" (38.1cm) deep, 18-1/2" (47cm) wide, and 6" (15.2cm) high by 17-9/16" (44.6cm) wide. The cabinet panel must be cut out 5-1/16" (12.9cm) high. Make this cutout carefully. The receiver's front panel has a 1/8" (.32cm) overhang on both sides and a 3/32" (.24cm) overhang on the top and bottom, (see Fig. 1)

The weight of the receiver must rest on a shelf in the custom cabinet with a 15" (38.1cm) x 8" (20.32cm) ventilation hole cut out. (see Fig. 2) In addition, a single 3/8" to 1/2" (1cm to 1.3cm) diameter hole (see Fig. 2 and Fig. 3) must be drilled in the shelf. A screw inserted through this hole secures the receiver after installation. The top of the shelf must be flush with the bottom of the custom panel cutout.

Fig. 1 Custom Cabinet Front Panel Cutout

Prepare the MAC 4200 for custom mounting by removing the wood sides and feet:

1. Remove 4 screws; two from each side panel and remove the panels.
2. On the bottom of the receiver are the 4 plastic feet held on by screws. Remove these feet. Do not attempt to remove the 4 plastic button glides as these rest against the shelf, (see Fig. 2 and 3) At this point the receiver is ready to be installed.

From the front of the cabinet, thread the power cord through the opening in the cabinet panel and slide the MAC 4200 on to the shelf. Adjust the position to evenly

cover edges of the panel cutout. Lock the unit in place with a screw and washer inserted through the drilled hole in the mounting shelf (see Fig. 3). Use a 1-1/4" (3.2cm) screw for 1/2" (1.3cm) shelf or a 1-1/2" (3.8cm) screw for 3/4" (1.9cm) shelf. Do not use longer screws since they will contact electrical circuits which can lead to equipment failure and possible injury.

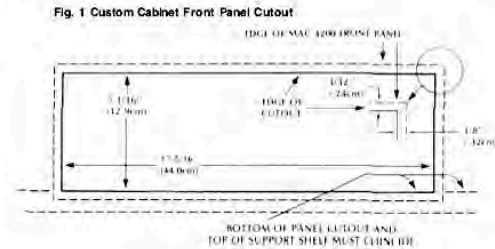

Fig. 2 Custom Cabinet Shell Mounting Cutout

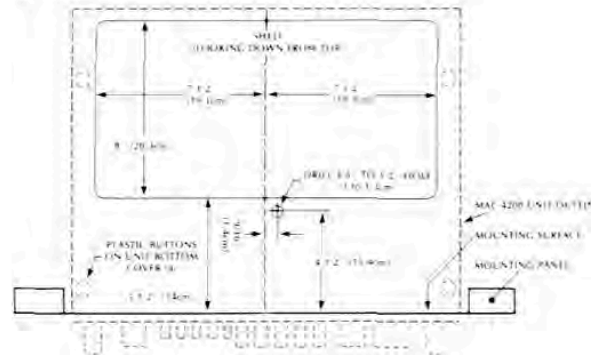
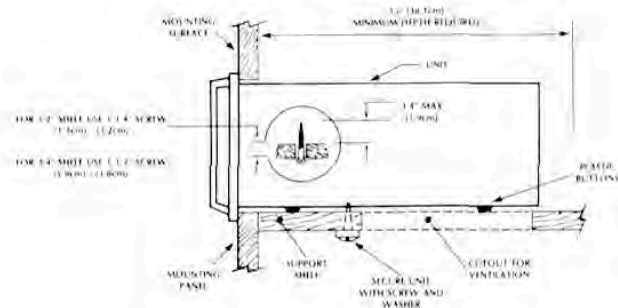

Fig. 3 MAC 4200 Custom Mounting Profile



## 4 INSTALLATION

Use shielded cables to connect the signal from the preamplifier or signal source to the power amplifier. To minimize the possibility of hum the shielded cables should be of parallel construction or loosely twisted together, located away from the speaker connecting cables and AC power cords. Be certain to use good quality shielded cables for all interconnections. Your dealer can advise you on the kind and length of cable that will best suit your installation.

The appropriate length and size of the loudspeaker cable for your installation will help to preserve the high quality of sound for which the loudspeakers have been designed. If undersize wire is used, resistance is added to the amplifier/loudspeakers combination which adversely affects the performance. Added resistance reduces the damping factor, modifies the frequency response and reduces the power output. Your dealer's advice will serve you best for your installation. The cables to and from the speaker should be of parallel construction or be loosely twisted together. The chart shows the recommended minimum wire size for the length of wire between the amplifier and the loudspeakers.

#### SPEAKER CABLE LENGTHS

##### AMPLIFIER TO SPEAKER

For 4 Ohm Load		For 8 Ohm Load		Wire Gauge
Feet	Meters	Feet	Meters	
15	4.6	30	9.1	18
25	7.6	50	15.2	16
40	12.2	100	24.4	14
60	18.3	120	36.6	12
100	30.48	200	60.0	10

These speaker cable lengths represent a wire resistance equal to 5% of a speaker impedance, or 97.5% transfer of power.

#### HOW TO CONNECT LOUDSPEAKERS

Rear panel push connectors are provided for three pairs of stereo speakers. The corresponding front panel pushbuttons turn the speaker pairs on or off.

Connect the leads from the left main (1) loudspeaker to the SPEAKERS L 1 and Common push connectors.

Connect the leads from the right main loudspeaker to the SPEAKERS R 1 and Common push connectors. Connect a second and third pair of speakers to the SPEAKERS 2 and 3 push connectors in a similar manner. To maintain frequency response, power output and damping characteristics, each speaker requires a separate cable between the receiver and the loudspeaker.

#### HOW TO CONNECT A TURNTABLE

Connect the left channel cable of the turntable to the L PH1 INPUT jack. Connect the right channel cable of the

turntable to the R PH1 INPUT jack. Connect a second turntable to the PH2 input jacks in the same way. Connect the turntable's ground wire to the GND terminal.

Automatically shorting phono jacks eliminate the potential for hum and crosstalk and the need for shorting plugs.

#### CONNECTING PROGRAM SOURCE GROUNDS

A ground (GND) post is provided to connect the grounds from record changers, tape decks, etc. To prevent hum pick-up, the left and right program cables and the ground wire from that source should be wound or loosely twisted together. Make sure the ground wire does not make any contact to the shields of the left and right program cables as they run between the source and the input of the preamplifier.

#### HOW TO CONNECT A CD PLAYER

Connect a cable from the left channel output of a compact disc player to the L CD input jack. Connect a cable from the right channel output to the R CD input jack.

When the MAC 4200 input selector switch is turned to CD/AU2 (compact disc player or auxiliary source) the station display area will show AU2.

#### HOW TO CONNECT TV AUDIO

Audio from a TV monitor or any other high level source is connected to the AUX INPUTS. Connect a cable from the left channel audio output of a TV monitor or other high level source, to the L AUX INPUT jack. Connect a cable from the right channel audio output to the R AUX INPUT jack.

When the MAC 4200 input selector switch is turned to the TV AU 1 position (television set or auxiliary source), the station digital display area will show AU 1.

#### HOW TO CONNECT TAPE RECORDERS TO RECORD:

Connect a cable from the MAC 4200 L TAPE 1 OUT jack to the left high level input of a tape recorder. Connect a cable from the R TAPE 1 OUT jack to the right high level input of a tape recorder. Connect a second tape recorder in the same manner to the TAPE 2 OUT jacks.

#### TO PLAYBACK OR MONITOR TAPE:

Connect a cable from the left channel output of a tape recorder to the MAC 4200 L TAPE 1 IN jack. Connect a cable from the right channel output of a tape recorder to the R TAPE 1 IN jack. Connect a second tape recorder in the same manner to the TAPE 2 IN jacks.

#### FRONT PANEL TAPE 2 RECORDER JACKS

TAPE 2 input and output connections are also available at the TAPE 2 IN-OUT jacks on the front panel. Metal shielded 1/4" stereo phone plugs are used. The connec-

# HOW TO CONNECT 5

tions are tip: left signal; ring: right signal; sleeve: common ground.

When a plug is inserted in the front panel TAPE 2 IN jack, the circuits to the rear panel TAPE 2 INPUTS are disconnected. Inserting a plug in the front panel TAPE 2 OUT jack does not disconnect the rear panel TAPE 2 OUT. It is possible to record from the front panel TAPE 2 OUT jack and the rear panel TAPE 2 OUT jack at the same time. However, it is not possible to listen (or monitor) from both the front and rear TAPE 2 IN jacks at the same time.

#### **THE ELECTRONIC MEMORY BATTERY POWER SUPPLY**

A very long life, rechargeable battery power supply provides the energy for the electronic memory when the receiver is turned off. When first connected, it is wise to assume that the batteries have not been charged. The charge rate is dictated by the 'on' time of the receiver. To bring the batteries to full charge, leave the receiver turned on for twenty-four continuous hours. Programmed instructions will be retained for more than six months with the receiver turned off if the batteries are fully charged. After the batteries are fully charged, use for approximately one hour per week, will maintain the batteries in a fully charged state.

#### **HOW TO CONNECT AC POWER**

A polarized AC plug is used on the MAC 4200. Plug it into a 120 volt 60 Hz wall outlet. The plug blades must be fully inserted in the outlet to prevent shock from exposed blades.

**CAUTION: TO PREVENT ELECTRIC SHOCK DO NOT USE THE (POLARIZED) PLUG ON THIS UNIT WITH AN EXTENSION CORD, RECEPTACLE OR OTHER OUTLET UNLESS THE BLADES CAN BE FULLY INSERTED TO PREVENT BLADE EXPOSURE.**

Three types of AC power outlets are provided on the back panel of the MAC 4200: 2 black, 2 green and one red.

The black outlets are switched on or off when the MAC 4200 is turned on or off. These are intended for CD players, equalizers or other accessories, whose total power requirement is 600 watts.

The red outlet is on at all times. For example, a VCR (video cassette recorder) can be plugged into this outlet for recording a TV program when the receiver is not turned on. Neither the red outlet nor the black outlets are fused.

AC power to the green outlets are controlled by the AUTOMATIC SYSTEM AC ON/OFF.

#### **AUTOMATIC SYSTEM AC TURN ON/OFF**

The POWER ON pushbutton shares AC power control,

with the AC power switch on a turntable, through a current detecting switch circuit. On the rear panel, the TURN-TABLE AUTO/MANUAL switch selects the mode of operation.

When the switch is in the AUTO position and a turntable plugged into one of the green AC power outlets, the AC power to the receiver and to the black AC power outlets can be controlled by the turntable on/off switch. When AC power to the turntable is turned on, power to the receiver and the black AC power outlets is turned on. When in the automatic mode, the system will remain on until the turntable is turned off. The POWER ON pushbutton controls the AC power when using any source other than the turntable.

In the MANUAL position only the red POWER ON pushbutton will turn AC power on or off. Power from the green AC power outlets can not exceed 100 watts.

Some turntables have electronic circuits that draw current all the time. To use these turntables the AUTO/MANUAL switch must be in the MANUAL position.

#### **CONNECTING AN FM ANTENNA**

Provisions have been made for the use of one of three antenna systems: (1) an outdoor FM antenna, or (2) a VHF-TV antenna, or (3) the indoor dipole supplied.

An outdoor antenna is recommended for optimum performance in all areas. In fringe (outlying) areas, best results will be obtained with a highly directional FM antenna used in conjunction with a rotator. If the antenna uses a 300 ohm lead, connect it to the ANTENNA 300 ohm FM push connectors.

If the antenna uses a 75 ohm coaxial cable, connect it to the rear panel ANTENNA 75ohm type F connector.

An outside antenna system should not be located in the vicinity of overhead power lines or other electric light or power circuits, or where it can fall into such power lines or circuits. When installing an outside antenna system, extreme care should be taken to keep from touching such power lines or circuits as contact with them might be fatal.

A VHF-TV antenna can be effective when it is designed for both FM and TV reception. Connect the two leads from the VHF-TV antenna to the ANTENNA 300 FM push connectors.

#### **CONNECTING AN INDOOR DIPOLE ANTENNA**

The flexible folded dipole antenna (300 ohm) is for use in urban or high strength signal areas. Connect the two leads from the dipole to the ANTENNA 300 FM push connectors.

The flexibility of the twin flat wire assembly permits it to be placed under a rug, tacked behind the stereo...or placed in any other convenient location. In some cases, it

---

## **6 HOW TO CONNECT**



# HOW TO CONNECT 7

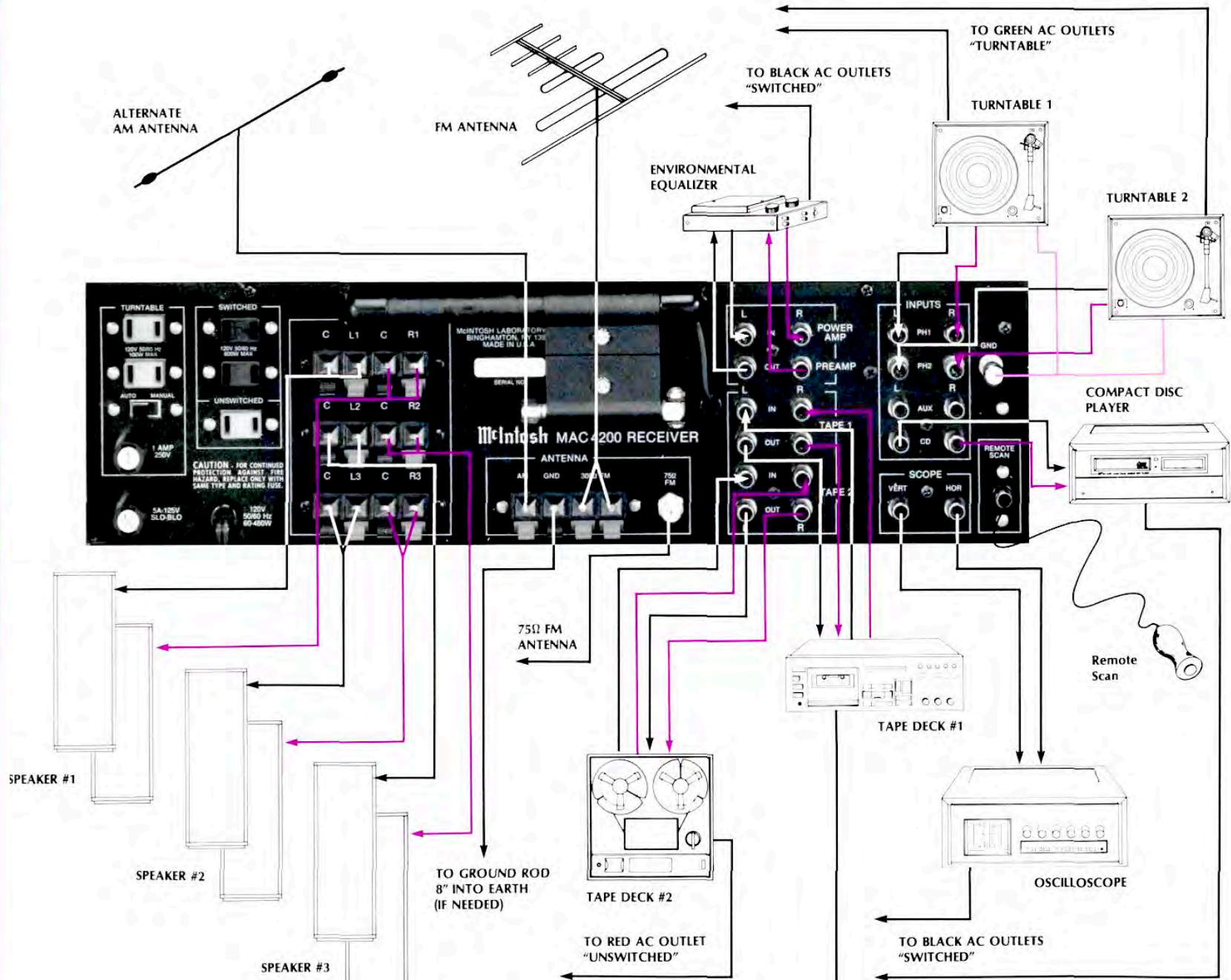

may be necessary to "position" the antenna for best signal reception. This should be done before it is permanently located.

Avoid locating the antenna next to other wires or metal objects. Any indoor antenna may be ineffective in houses having metal siding or metal foil insulation.

#### **AM ANTENNA**

For local and most moderately distant AM reception the built-in ferrite loopstick antenna may be used. The loopstick is mounted on a swivel base and must be adjusted away from the chassis for best reception.

Distance reception can be improved with the use of a copper antenna wire 50 to 150 feet in length. Suspend the wire, horizontally, in a straight line as high as possible. Attach the wire to an anchor at each end with suitable glass or ceramic insulators. Connect a lead-in wire at a convenient point on the antenna. Use a lightning arrester for protection with an outdoor AM antenna. The arrester should be well grounded to a ground rod or cold water pipe.

#### **HOW TO CONNECT A McINTOSH EQUALIZER**

POWER AMP IN and PREAMP OUT jacks are provided on the rear panel for connecting a McIntosh Environmental Equalizer, or other signal processing equipment. Connect the left and right shielded cables from the signal processor outputs to the Left and Right POWER AMP IN jacks. Then connect shielded cables between the Left and Right PREAMP OUT jacks to the equalizer inputs.

The input jacks are automatic switching jacks that disconnect the preamplifier's output signal from the power amplifier's input and connects the signal processor's output with the power amplifier's input.

#### **HOW TO CONNECT**

##### **ADDITIONAL POWER AMPLIFIERS**

External power amplifiers may be fed from the MAC 4200 in two ways:

1. Connect a shielded cable from the Left and Right PREAMP OUT jacks to the Left and Right input of the power amplifier. The PREAMP OUT jacks are affected by the VOLUME, EQUALIZER, BALANCE and LOUDNESS controls. Both the MAC 4200 amplifier and the additional amplifier will be fed from the preamplifier. If the MAC 4200 amplifier is not going to be used, insert a pair of non-shortening phono plugs in the POWER AMP IN jacks to disconnect it from the preamplifier output.
2. The TAPE 1 or TAPE 2 OUT jacks may be used to drive an external amplifier which has its own controls. The output of these jacks is not affected by the VOLUME, EQUALIZER, BALANCE and LOUDNESS controls on the receiver. A suggested use would be to feed an amplifier in a remote location where volume and tone re-

quirements need to be controlled at the remote amplifier. In this configuration, the TAPE 1 connections can not be used for a tape recorder.

#### **HOW TO CONNECT REMOTE SCAN**

The remote scan switch/cable assembly plugs into the rear panel REMOTE SCAN input jack. The cable assembly is a McIntosh accessory (Part No. 045-515) available from your dealer.

---

## **8 HOW TO CONNECT**

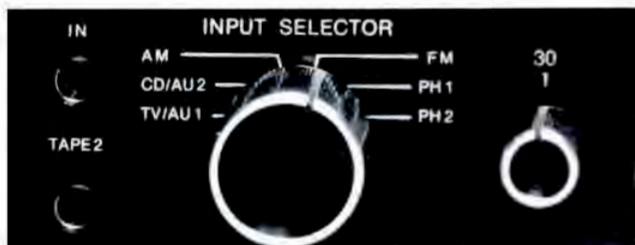

### INPUT SELECTOR

Use the six position INPUT SELECTOR switch to select the program source to which you wish to listen. The program selected will also be fed to the TAPE OUT jacks.

TV/AU1: To listen to any high level source such as a TV monitor or tape recorder. The station display area will show AU1.

CD/AU2: To listen to a compact disc player or other high level source. The station display area will show AU2.

AM: To listen to AM radio broadcasts. The station display area will show the AM station frequency in kilohertz.

FM: To listen to FM stereo radio broadcasts. The station display area will show the FM station frequency in megahertz.

PH1: To listen to a record player connected to PH1 input jacks. The station display area will show PH1.

PH2: To listen to a second record player connected to the PH2 input jacks. The station display area will show PH2.

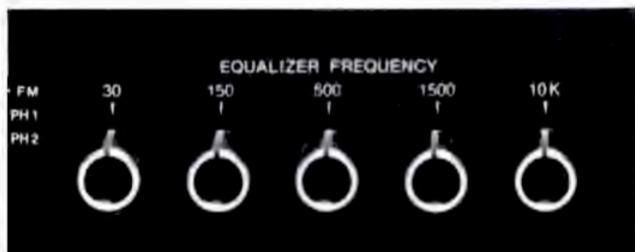

### EQUALIZER FREQUENCY CONTROLS

Each of the five EQUALIZER FREQUENCY controls raises or lowers the volume of a band of frequencies whose center is the frequency marked above the control. Both left and right channels are affected by each control. The center or flat response position of each control has a detent for easy reference. When each control is in the detent position the equalizer is removed from the pre-amplifier circuits and the response is perfectly flat with the equalizer circuits removed from the signal path.

Use the EQUALIZER FREQUENCY controls to modify the sound and balance of program material. Here are some suggestions with which to start.

ADJUSTMENT TO:	EQUALIZER CORRECTION
Make deep bass louder	Raise 30
Make all bass louder	Raise 30 and 150
Reinforce voices	Lower 150 and raise 500
Brighten violins and trumpets	Raise 1500
Emphasize cymbals	Raise 10k



## USING THE PUSHBUTTONS

### TAPE PUSHBUTTONS:

The MAC 4200 is designed so it may be used with two tape recorders. Four TAPE pushbuttons control the signal inputs and outputs of the tape recorders. Recordings can be monitored as they are being recorded. Tapes can also be copied from one recorder to another while listening to a different program source.

The MONITOR switches are mechanically interlocked to prevent simultaneous monitoring from two tape recorders. If one button is at the IN position, it must be pushed again to release it to the OUT position before the other button can be pushed.

With either MONITOR pushbutton at the IN position, the program heard will be that from the tape recorders only. Signal from any other source will not be heard from the loudspeakers. To hear any other source, make sure the MONITOR pushbuttons are OUT.

### MONITOR...TAPE 1

Pushbutton OUT: The program source selected by the INPUT SELECTOR will be heard through the speakers.

Pushbutton IN: Program from a tape recorder plugged into TAPE 1 IN will be heard through the speakers.

### MONITOR...TAPE 2

The functions are the same as MONITOR...TAPE 1. In addition, it controls the signal from a tape recorder plugged into the front panel TAPE IN jack. A recorder plugged into the front panel jacks disconnects the rear panel TAPE 2 IN jacks, automatically. The TAPE 2 OUT jacks on both front and rear panels are always connected.

TAPE COPY...T1->T2 pushbutton in: connects the output from tape recorder 1 to the input of tape recorder 2 without affecting the program being heard from the speakers. In this position, a copy of the program on tape recorder 1 can be made on tape recorder 2. To monitor the original, use MONITOR...TAPE 1 pushbutton. To monitor the copy use MONITOR...TAPE 2 pushbutton.

TAPE COPY...T2->T1 pushbutton in: connects the output from tape recorder 2 to the input of tape recorder 1 without affecting the program being heard from the speakers. In this position a copy of the tape program on recorder 2 can be made on recorder 1. To monitor the original use MONITOR...TAPE 2 pushbutton. To monitor the copy use MONITOR...TAPE 1 pushbutton. When both MONITOR pushbuttons are out, you hear the program selected by the INPUT SELECTOR.

---

# 10 FRONT PANEL CONTROLS

### MONO

The MONO pushbutton switches the audio output of the receiver from stereo mode to MONO. When the INPUT SELECTOR is in the FM position and tuned to a stereo broadcast the FM MPX light will remain on regardless of the position of the MONO pushbutton. The program, with the MONO pushbutton in, will be heard as mono. The TAPE OUT jacks are not affected by the MONO or MUTE pushbuttons.

With the MUTE pushbutton in, and when using the manual tuning knob, between station noise and weak noisy stations are suppressed. FM muting automatically eliminates between station noise when using the preset station selector feathertouch-buttons or when SCAN tuning.

### SPEAKERS 1, 2, and 3

When each of these pushbuttons are pressed IN, the output of the receiver is fed to the pair of loudspeakers connected to the corresponding rear panel SPEAKER push connectors. SPEAKERS 1, 2, and 3 may be selected singly, in any combination or all at once.

### POWER ON

The red pushbutton turns the AC power on or off. When the power is on, the display area panel illuminates. The turntable can also be used as a power switch. (See "HOW TO CONNECT" "AUTOMATIC SYSTEM TURNON/OFF".)

### BALANCE AND LOUDNESS:

The BALANCE and LOUDNESS controls are concentric. Adjusting the BALANCE control (large outer knob) adjusts the volume of the channels relative to each other and does not change the overall volume of sound in your listening room.

### LOUDNESS:

After setting the VOLUME control for the desired listening level, adjust the LOUDNESS control for the preferred compensation. Adjusting the LOUDNESS control will not affect the overall volume of sound in your listening room.

The LOUDNESS control (small center knob) contours the frequency response to compensate for the hearing characteristic of the human ear at lower listening levels. The contour is accurately modeled after the family of "equal loudness" curves identified by Fletcher and Munson. At the fully counterclockwise detented position, the LOUDNESS compensation is out of the circuit, so the



response is electrically flat. As the control is turned clockwise, both bass and treble frequencies increase in the correct proportion to each other. The contour is not affected by different settings of the VOLUME control.



#### VOLUME

The VOLUME control is a precision step control manufactured for McIntosh Laboratory. It has 32 steps with a 70 dB range. Left and right channel tracking is within a fraction of a dB. This extreme accuracy is obtained through special electronically controlled resistance element trimming.

#### HEADPHONE JACKS

Plug headphones into the front panel HEADPHONE jack. Adjust the front panel VOLUME control for comfortable headphone listening.

Signal to the headphone jacks is constant and is not affected by the SPEAKER switches.

The circuits feeding the HEADPHONE jacks have been designed to feed low impedance dynamic headphones. Electrostatic headphones generally require higher power than dynamic headphones. Connect electrostatic headphones to the SPEAKER push connectors on the rear panel.



#### PRESET STATION SELECTING

##### FEATHERTOUCH-BUTTONS

A momentary press on one of the feathertouch-buttons marked 1 through 6, will recall from the electronic memory the preset AM or FM station assigned to that feathertouch-button. The corresponding red indicator above the digital frequency display will then light.

#### ENTER

The ENTER feathertouch-button and any one of the six momentary feathertouch-buttons are used to insert into the electronic memory the tuned FM or AM station. Six AM and six FM stations can be preset.

To enter a station in the memory, tune to the desired station with either the manual tuning knob or SCAN tuning. Then, while pressing the ENTER feathertouch-button, press feathertouch-button 1. Release both feathertouch-buttons and the station tuned will be recorded in the electronic memory for instantaneous recall when feathertouch-button 1 is pressed.

The preset memory circuits are maintained by a special long life battery power supply that is charged when the AC power is turned "ON". When the receiver is first connected it is wise to assume that the batteries have not

---

## 12 FRONT PANEL CONTROLS

been charged. The charge rate is dictated by the time the receiver is turned 'on' without regard to the mode of operation. For instance the batteries will charge should you wish to play records, or tape on FM. To bring the batteries to full charge, operate for twenty-four continuous hours. When fully charged, and with the receiver turned off the programmed instructions will be retained for more than six months. After the batteries are fully charged, use for approximately one hour per week, will maintain the batteries in a fully charged state.



#### MANUAL

A momentary press of the MANUAL feathertouch-button will activate the manual tuning knob and the red indicator above the knob will turn on. Rotate the tuning knob until the frequency of the desired station shows in the station display area.

A station is correctly tuned when the center vertically displayed ( $\Delta$ ) arrow at the bottom of the SIGNAL/TUNING display, lights. On each side of the center arrow are horizontally displayed ( $\blacktriangleright$   $\blacktriangleleft$ ) arrows. One of these will light as a station is approached to indicate tuning above or below the center frequency of the FM station. FM stations broadcasting in stereo light the FM MPX bar indicator above the SIGNAL/TUNING indicator.

An AM station is correctly tuned when the center (vertically displayed) arrow at the bottom of the SIGNAL/TUNING display lights. On AM, the horizontally displayed arrows do not function.

A momentary press on any of the numbered feathertouch-buttons or SCAN activates that tuning method selected and deactivates the manual tuning knob.

#### SCAN

Use the SCAN feathertouch-button to automatically tune to the next station either up or down the broadcast band selected. The arrow beside the feathertouch-button indicates the direction of the scan. When a remote scan cable/switch is inserted in the rear panel receptacle, a momentary press of the remote button will activate the tuner scan-up circuit. The remote scan cable/switch assembly, (McIntosh Part No. 045-515) can be obtained from your McIntosh dealer.



#### SIGNAL/TUNING INDICATOR

The SIGNAL/TUNING indicator is to the right of the station display area. The vertical column of LED indicators show the relative signal strength of an AM or FM station being received. The greater the number of dots illuminated, the greater the received station's signal strength.

#### AFL

While tuning, the automatic frequency lock (AFL) circuit is deactivated. When properly center channel tuned, the center tuning arrow lights and the AFL circuit activates to lock on to the broadcast station's precise frequency preventing any detuning or drift from the broadcast station. The locking action of the AFL circuit makes tuning easy. McIntosh AFL will give the best FM and AM reception with lowest background noise, lowest distortion and highest FM stereo channel separation.

Although the tuner can be tuned very slightly off the station's frequency without degrading the program material, this "near" tuning can cause the station to be 'lost' when power is turned off and then turned on again. To prevent this, always rotate the manual tuning knob until the center tuning arrow only is lighted.

The MANUAL AFL switch is on the back panel, behind the AM loopstitch antenna. Set this switch to NORMAL for most listening. To make it easier to tune a weak station next to a strong station use the manual tuning knob with the MANUAL AFL switch in the OUT position.



#### POWER OUTPUT INDICATORS

The amplifier POWER output indicators are to the left of the station display area. There are two vertical columns of red Light Emitting Diode (LED) bar indicators; one for each channel.

The left column represents the output from the left channel and the right column the right. Each row is independent of the other. As power output increases, more bar indicators are turned on. The power indicators provide constant and instant information on the amount of power being fed to your speakers.

When the POWER GUARD\* circuit is activated, the top bar on each side will light and the other POWER indicators turn off.

\*U.S. Patent #408573

## 14 FRONT PANEL CONTROLS



### POWER GUARD\*

POWER GUARD\* assures that the amplifier can not be overdriven so amplifier output clipping is eliminated. Clipping is caused when the amplifier is asked to produce more power output than it can deliver with low distortion. Amplifiers are capable of delivering large quantities of power when they are driven to clipping and can have more than 40% harmonic distortion. The extra energy content of the clipped signal will damage most speakers. A McIntosh advancement helps to protect your speaker from this kind of damage. The POWER GUARD\* circuit compares the wave shape of the input signal with the output signal. If the non-linearity between the two signals exceeds 0.5% the POWER GUARD\* circuit operates.

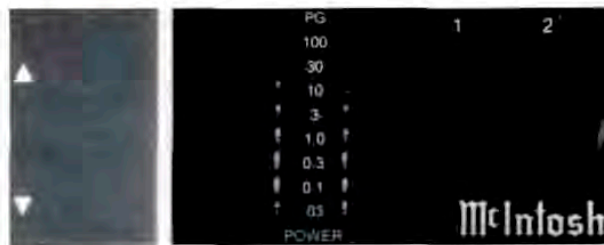

### BALANCE YOUR STEREO SYSTEM

The performance and enjoyment of a stereo system is greatly increased when the sound is properly balanced. The balance of the stereo system is affected by many things including the phase relationship of the loudspeakers, room acoustics, furniture placement, room shape, small differences in loudspeakers etc.

### TO ADJUST LOUDSPEAKER PHASE

Press the MONO pushbutton. Play a familiar recording. Turn the BALANCE control to 12 o'clock. Stand about ten feet in front of and midway between the loudspeakers. The sound should appear to come directly from in front of you. If the sound is not directly in front of you, reverse the leads on one of the loudspeakers only. When the sound comes from the midpoint between the speakers they are in phase.



### TO BALANCE LOUDNESS

Press the MONO pushbutton. Turn the BALANCE control to the 12 o'clock position. While the program is playing, stand between the two loudspeakers. For any difference in loudness between speakers, turn the BALANCE control toward the speaker that is not as loud. Adjust until the sound is equal in loudness from each speaker.

### PERFORMANCE GUARANTEE

Performance Limits are the maximum deviation from perfection permitted for a McIntosh instrument. We promise you that when you purchase a new MAC 4200 from a McIntosh franchised dealer, it will be capable of or can be made capable of performance at or exceeding these limits or you can return the unit and get your money back. McIntosh is the only manufacturer that makes this statement.

### PERFORMANCE

McIntosh audio power ratings comply with the Federal Trade Commission Regulation concerning power output claims for amplifiers used in home entertainment products.

### POWER OUTPUT

100 watts minimum sine wave continuous average power output, per channel, both channels operating into 4 ohms, 20 Hz to 20 kHz, with no more than 0.02% total harmonic distortion.

75 watts minimum sine wave continuous average power output, per channel, both channels operating into 8 ohms 20 Hz to 20 kHz, with no more than 0.02% total harmonic distortion.

### OUTPUT LOAD IMPEDANCE

4 ohms, and 8 ohms

### RATED POWER BAND

20 Hz to 20,000 Hz

### TOTAL HARMONIC DISTORTION

0.02% maximum harmonic distortion at any power level from 250 milliwatts to rated power per channel from 20 Hz to 20,000 Hz, both channels operating.

### INTERMODULATION DISTORTION

0.02% maximum harmonic distortion at any power level from 250 milliwatts to rated power per channel both channels operating for any combination of frequencies 20 Hz to 20 kHz.

### FREQUENCY RESPONSE

20 Hz to 20 kHz +0 -0.5 dB at rated power.

### NOISE AND HUM

**Power Amp:** 100 dB below rated output (85 dB IHFA).

**Tape and AUX Input:** 95 dB below rated output (80 dB IHFA).

**Phono Input:** 90 dB below 10 mV input (80 dB IHFA).

### DAMPING FACTOR

Greater than 40

### INPUT SENSITIVITY AND IMPEDANCE

**Power Amp:** 2.5V (280mV IHF); 22,000 ohms

Tape and AUX: 250 mV (28mW IHF), 35,000 ohms

**Phono:** 2mV (22 $\mu$ V IHF), 47,000 ohms 47 pF

### TAPE OUTPUT

**Tuner:** 1.0 V at 100% modulation (FM)

**Tape:** 250 mV with rated input

**Phono:** 250 mV with rated input

### PROGRAM EQUALIZER

$\pm$ 12 dB at 30, 150, 500, 1500, and 10,000 Hz

### FM SECTION

#### SENSITIVITY

20  $\mu$ V across 300 ohms 1.0 $\mu$ V across 750 ohms (11.25 dB)

#### SIGNAL TO NOISE RATIO

STEREO: 70 dB minimum

MONO: 75 dB minimum

#### HARMONIC DISTORTION:

MONO: 0.08% at 100 Hz

0.08% at 1000 Hz

0.12% at 10,000 Hz

STEREO: 0.12% at 100 Hz

0.12% at 1000 Hz

0.50% at 10,000 Hz

#### FREQUENCY RESPONSE

20 Hz to 15 kHz +0, -1 dB

#### CAPTURE RATIO

1.5 dB

#### ALTERNATE CHANNEL SELECTION

65 dB

#### SPURIOUS REJECTION

100 dB

#### IMAGE REJECTION

80 dB

#### STEREO SEPARATION

45 dB at 100 Hz

55 dB at 1000 Hz

35 dB at 10,000 Hz

#### SCA REJECTION

65 dB minimum

---

# 16 PERFORMANCE LIMITS

## AM SECTION

### SENSITIVITY

75 $\mu$ V IMF (External antenna)

### SIGNAL TO NOISE RATIO

50 dB at 30% modulation, 60 dB at 100% modulation

### HARMONIC DISTORTION

1% maximum at 30% modulation (0.3% typical)

### FREQUENCY RESPONSE

-6 dB, at 3500 Hz

### ADJACENT CHANNEL SELECTIVITY

30 dB minimum IHF

### IMAGE REJECTION

60 dB minimum, 540 kHz 1600 kHz

## GENERAL INFORMATION

### SEMICONDUCTOR COMPLEMENT

142 Silicon Diodes  
18 Tuning Devices  
1 Silicon Controlled Rectifier (SCR)  
42 Light Emitting Diodes  
4 Seven Segment LED Displays  
67 Bipolar Transistors  
21 Field Effect Transistors  
37 Integrated Circuits

### AC POWER OUTLETS

2 Green, turntable current-sensing, 100 watts  
2 Black, switched, 1 Red, unswitched, 1200 watts, total

### POWER REQUIREMENTS

120 volts, 50/60 Hz, 60 to 480 watts

### MECHANICAL INFORMATION

#### SIZE

Width: 18-9/16 inches (47.1 cm); with walnut wood sides removed: 17-9/16 inches (44.6 cm). Height: 6-1/16 inches (15.4 cm); with the feet removed 5-1/4 inches (13.3 cm). Depth: 14 inches (35.6 cm) from the mounting surface to the rear panel, including connectors. Knob and handle clearance required is 1-1/16 inches (2,7 cm) in front of the mounting surface.

#### FINISH

Front panel is brushed black anodized with gold anodized trim. Side panels are machined solid walnut with satin lacquer finish.

#### WEIGHT

40 pounds (18.1 kg) net, 54 pounds (24.5 kg) in shipping carton.

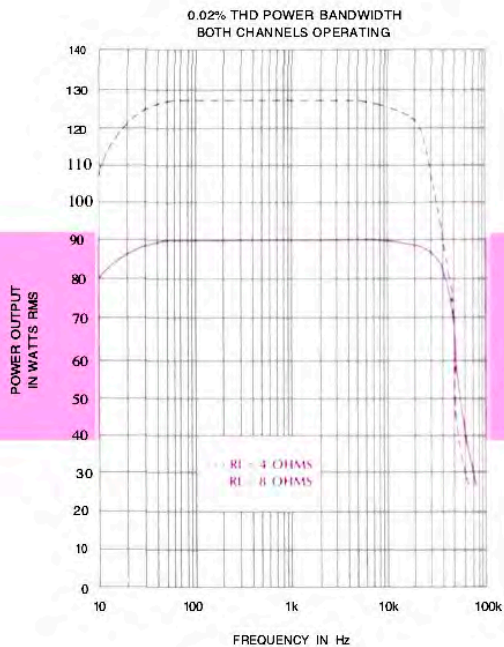
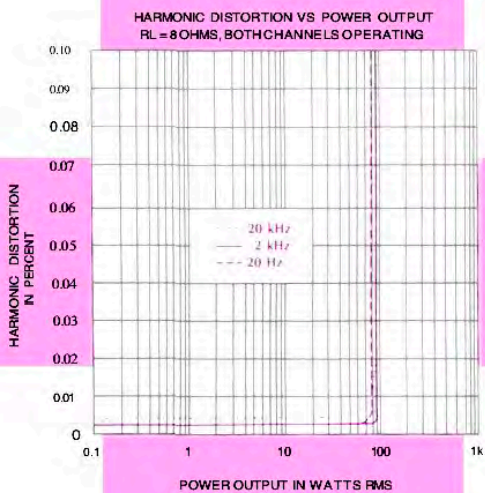
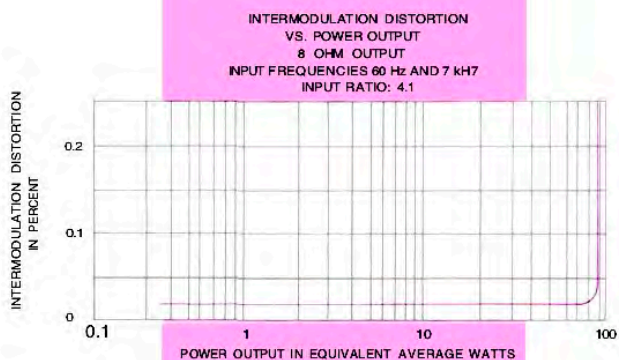
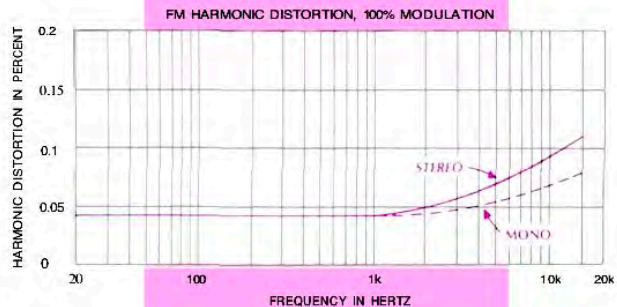

# 18 PERFORMANCE CHARTS

OUTPUT SIGNAL WAVEFORM SHOWING ACTION OF POWER GUARD TO ELIMINATE OUTPUT SIGNAL CLIPPING. POWER AMPLIFIER INPUT IS OVERDRIVEN BY 20 dB FOR BOTH OSCILLOGRAM TRACES.

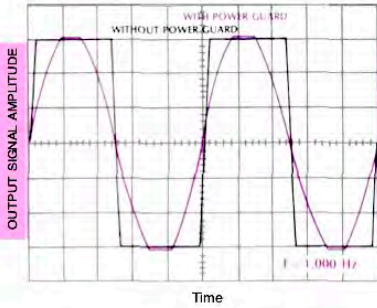

FREQUENCY RESPONSE OF EQUALIZER FREQUENCY CONTROLS SET AT MAXIMUM AND MINIMUM

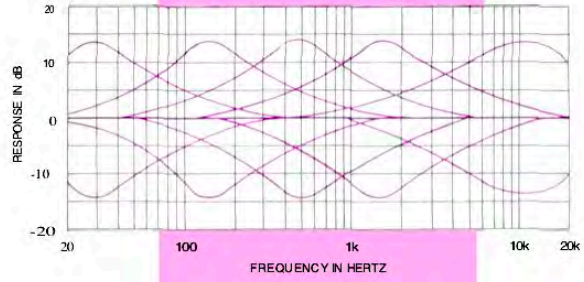

FM PERFORMANCE, 98 MHz 1kHz MODULATION

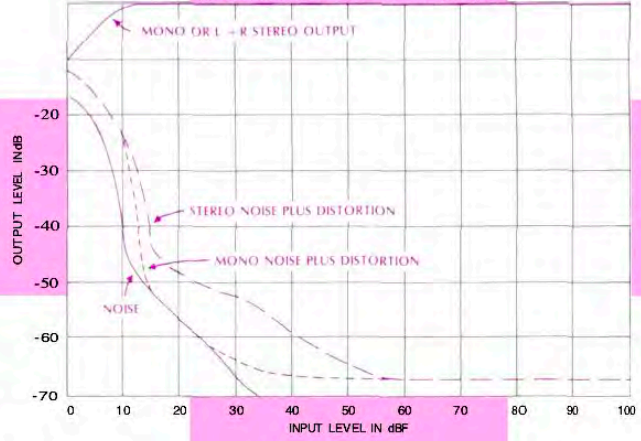

FM FREQUENCY RESPONSE AND STEREO SEPARATION



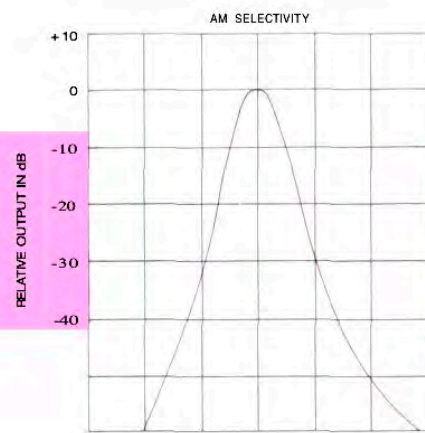
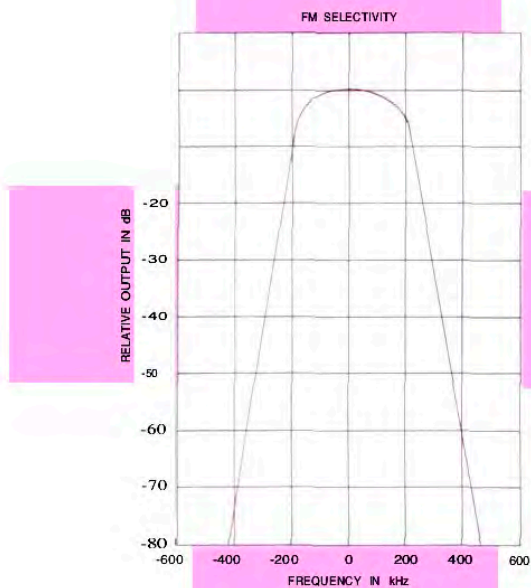
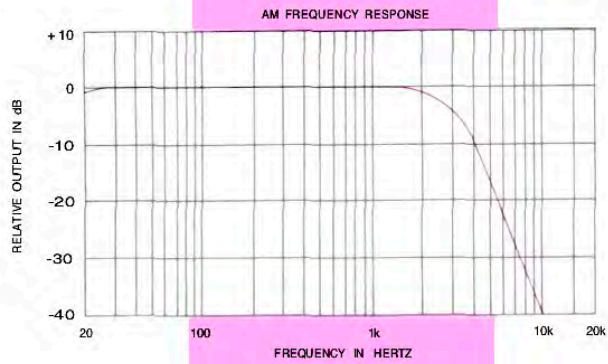

---

# 20 PERFORMANCE CHARTS

#### **ELECTRONIC INPUT SWITCHING**

Input switching is done electronically using J-FET field effect analog switches. The front panel switch controls small amounts of DC voltage which turn the J-FET analog switches on or off. The critical audio signals are switched silently with instantaneous muting between switch positions. No transient switching noises or pops are present with this superior design.

#### **PHONO AMPLIFIER**

The phono amplifier uses a high technology integrated circuit operational amplifier. Its differential input stage has been optimized for low noise and low distortion performance. The integrated circuit's open loop gain is 100,000. With high open loop gain a large amount of negative feedback can be used around the phono amplifier to further reduce noise and distortion. The feedback network, provides in addition, RIAA frequency compensation. Components in the network are 1% metal film resistors and 5% poly film capacitors. To achieve low noise performance it is essential that the feedback network be very low impedance. The actual power output capability of this preamplifier stage is more than 100 milliwatts.

The phono amplifier has a very wide dynamic range. Input sensitivity of the phono amplifier is 2 millivolts with a gain of 40 dB at 1000Hz. At 1000Hz the phono input circuit will accept 100 millivolts without overload. This is a voltage far greater than the output of any currently used magnetic phono cartridge, assuring protection from overload. 10 millivolts at the phono input at 1000Hz will produce 1 volt at the tape output. The tape output source impedance is 200 ohms, designed to operate into a load impedance of 10,000 ohms or greater.

#### **HIGH LEVEL AMPLIFIER**

At the input to the high level or loudness amplifier the signal passes through the mode switch matrix, then through the volume control, and into the amplifier. Typical loudness controls have used simple passive circuits connected to a tap on the volume control. As a consequence, compensation accuracy was dependent on many variables such as volume control position and differences in the input level. The MAC 4200 loudness control uses active circuits composed of an integrated circuit operational amplifier with two feedback loops. One has flat frequency response. The other has response conforming to the Fletcher-Munson equal loudness contours. A potentiometer is placed between these two feedback loops making it possible to select any combination of the two, from a flat response to full loudness compensation. The overall gain of the stage is 15 dB at mid-frequencies. Listening volume is not affected by the position of the loudness control.

#### **EQUALIZER AMPLIFIER**

The equalizer amplifier uses high technology integrated circuit operational amplifiers with the output stage optimized for the best transient performance with minimum distortion. Five other operational amplifiers are arranged in a circuit configuration equivalent to a series tuned circuit, one at each of the five center frequencies. Each circuit is activated by the control potentiometer in either the input circuit or feedback circuit of the operational amplifier providing a boost and cut capability of 12 dB for each band of frequencies. When the potentiometer is in the center or detent position, the operational amplifier is out of the circuit completely.

#### **POWER AMPLIFIER SECTION**

The MAC 4200 power amplifier requires 1.4 volts RMS to drive it to rated output. The input impedance is 22,000 ohms. The input stage of the amplifier uses two transistors connected as a differential amplifier output. The differential amplifier permits the best use of negative feedback for low noise and low distortion performance. The outputs of the differential amplifier are combined in a current mirror to form a single output. This combined signal feeds a linear voltage amplifier which drives two medium power driver transistors. The driver transistors feed the output stage.

The output stage is arranged as a fully complementary, direct coupled, push/pull amplifier. The power transistors used are selected for their high power dissipation capability, wide frequency response, and large safe operating area. All power transistors have limits for the maximum amount of heat they can tolerate. The MAC 4200 uses a highly efficient amplifying circuit which produces relatively little heat for the output power produced. The receiver has 4 oversized heat sinks to dissipate transistor generated heat. Under normal conditions, the output transistors operate well below their safe temperature limits. If ventilation is restricted by improper mounting or if amplifier efficiency is destroyed by operating it into a short circuit or a very low impedance, extra heat will be produced.

All power transistors have limits for the maximum amount of electrical current they can handle, the MAC 4200 output circuit and the power supply has been designed to allow very high current flow into properly matched load impedances yet continue to operate well within the design limits. Should a short circuit or very low value of load impedance be applied to the output of the MAC 4200, destructive currents could be reached if they were not controlled by the SENTRY MONITOR (US Patent #4048573) circuit. The circuit senses the dynamic operating conditions of the amplifier output stages and controls the current flow, confining it to safe limits. The

SENTRY MONITOR circuit does not limit the power output available from the amplifier nor does it have any effect on signals passing through the amplifier when operating conditions are normal.

A power amplifier which does not use output transformers to bypass DC (direct current), can destroy loudspeakers should there be a failure within the amplifier. Safety circuits are necessary to protect loudspeakers. The MAC 4200 has a DC detecting circuit connected to the output of each channel. When DC is present, this circuit reacts in milliseconds to open the speaker relay. The speakers remain disconnected until the cause has been corrected. Under normal operating conditions the DC protective circuit has no effect on the operation of the output circuit.

#### POWER GUARD

POWER GUARD (US Patent #4048573), a unique feature of McIntosh amplifiers, assures that each channel of the MAC 4200 will deliver full power free of clipping distortion. Clipping is caused when an amplifier is asked to produce more power output with low distortion than its design characteristics permit. Amplifiers when driven to clipping can deliver large quantities of power that will have more than 40% harmonic distortion which causes the sound to be grossly distorted. The extra energy content of the clipped signal will damage most loudspeakers, particularly high frequency speakers. The McIntosh POWER GUARD circuit protects your ears and your speakers from this kind of damage.

The McIntosh patented POWER GUARD circuit eliminates amplifier clipping due to overdrive. It also illuminates the red Power Guard indicators at the top of the POWER indicator when the amplifier is driven beyond its maximum output capacity.

The POWER GUARD circuit compares the wave shape of the amplifier input and output signals. Normally there is no disparity between these signals and the comparison produces no output. When the amplifier is driven beyond its maximum power capacity a difference will develop. If the disparity exceeds 0.5% (equivalent to 0.5% total harmonic distortion) the difference will cause the Power Guard bar indicators to light. If there is a further increase in the disparity the difference output controls a fast acting (microseconds) electronic attenuator at the amplifier input to reduce the amplifier gain, thus holding the amplifier output to its maximum undistorted value regardless of the degree of overdrive to the amplifier. The amplifier must be overdriven by 20 dB before the output distortion exceeds 2%.

The comparison is achieved in an especially compensated operational amplifier integrated circuit. Its output is

detected by a full wave bridge that feeds signals to the control circuitry for the Power Guard indicators and to the electronic attenuator at the amplifier input. The attenuator is a light emitting diode/light dependent resistor network selected for its low distortion and time constant characteristics.

#### TURN ON DELAY

The MAC 4200 has transient-free turn on/turn off characteristics, time-controlled by a transistor switch that operates a heavy duty relay which connects the outputs to the speakers. The control to the transistor switch is derived from a long time constant capacitor charging network which energizes the relay approximately one second after the AC power switch is turned on. The same circuit has a short turn-off time constant which causes the relay to drop out before the receiver's main power supply has a chance to discharge.

#### POWER SUPPLY

Two high current power supplies, a positive 48 volt and a negative 48 volt DC are used to drive the output power amplifier. Four large filter capacitors, 6800 microfarads each, are used to store the large amount of energy necessary for good filtering and precise voltage regulation. A stable well regulated power supply is required for proper low frequency response and negligible low frequency distortion.

---

## 22 TECHNICAL DESCRIPTION



MAC 4200 RECEIVER

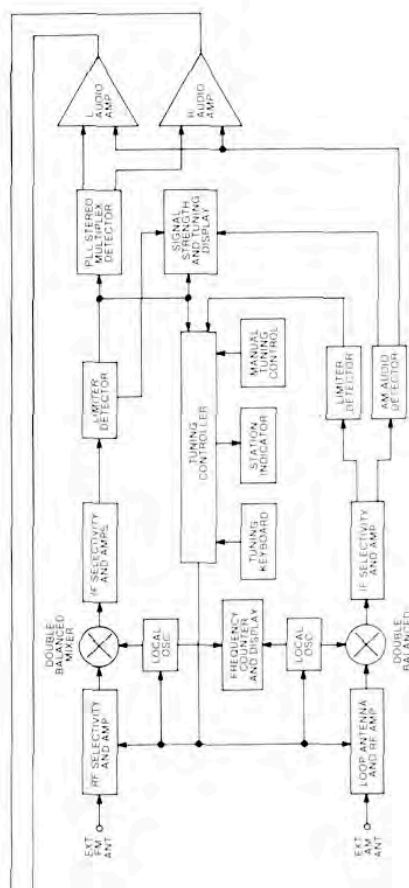
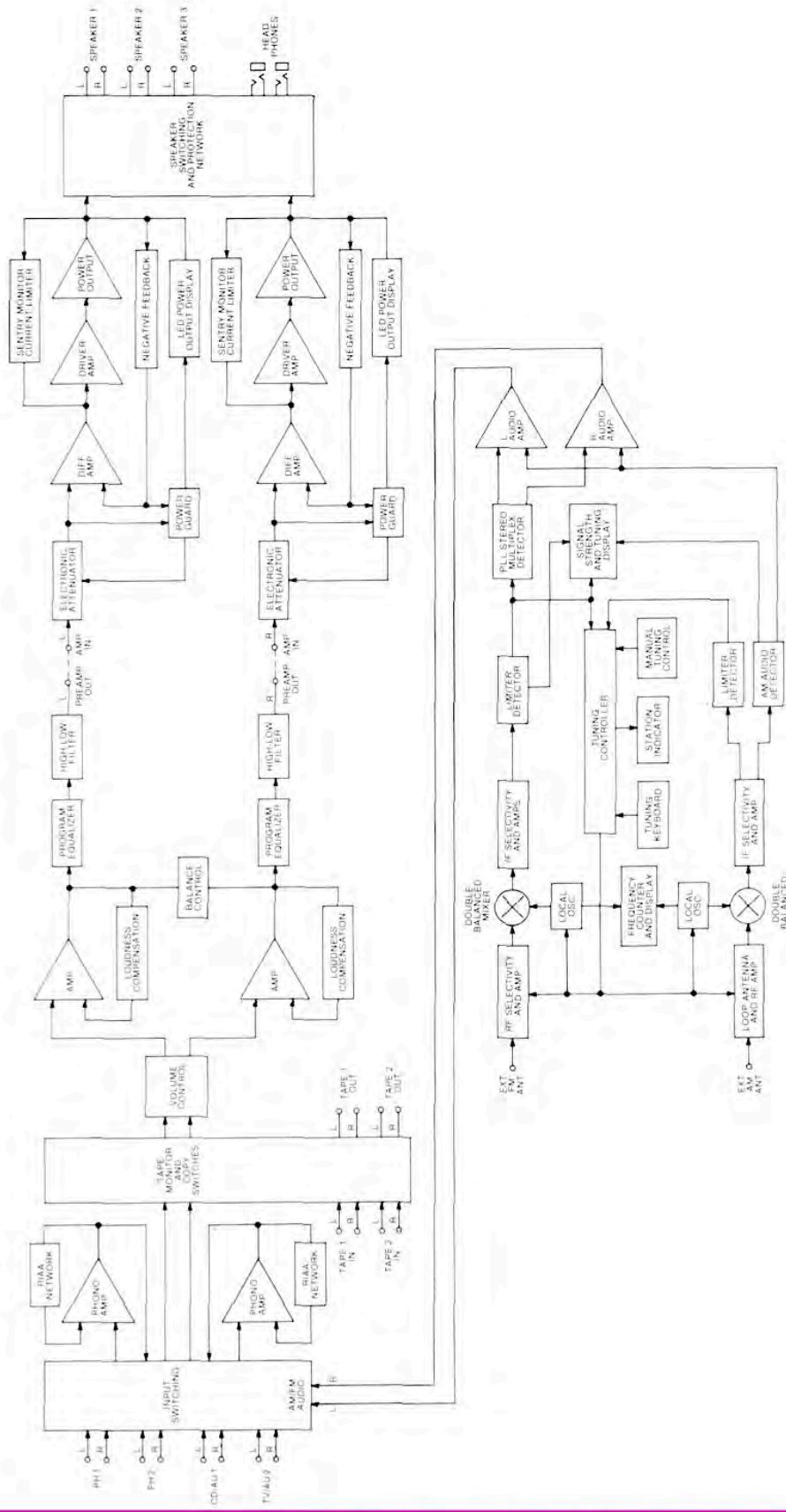

BLOCK DIAGRAM 23

"...McIntosh is  
one of a kind  
in the world of  
quality audio..."

McIntosh owner  
M. C. Memphis, TN

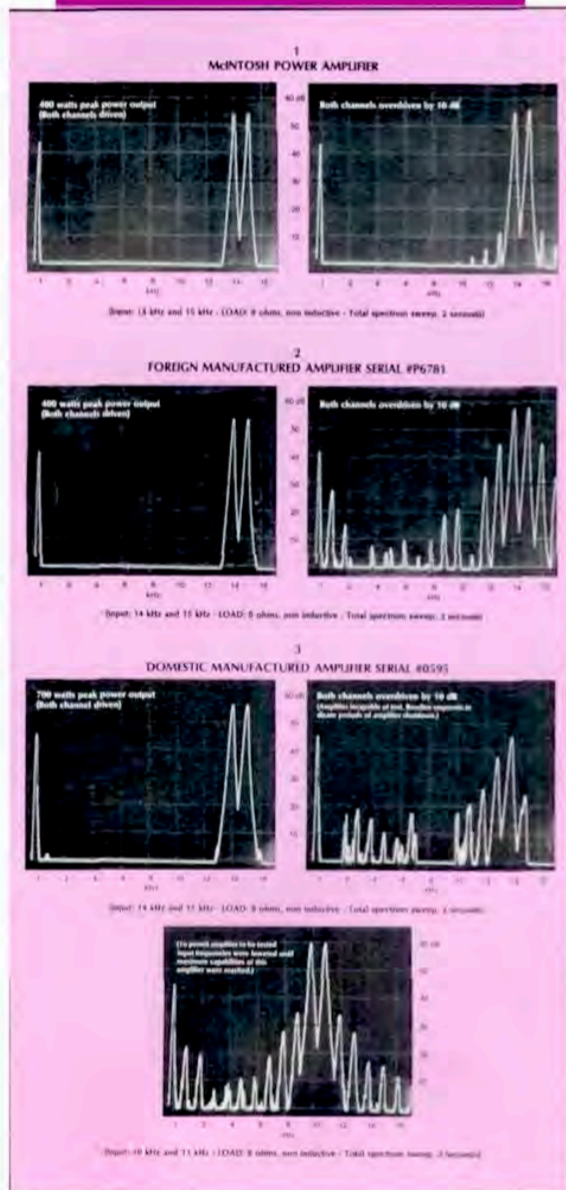

Compact Discs have been proclaimed to have a large increase in "dynamic range". Dynamic range is the ratio, usually given in decibels, between the softest, quietest sound on the disc and the loudest. Most Compact Discs claim a dynamic range in excess of 90 decibels. In numerical ratio this is greater than 1000 times the ratio of practical commercial analog records.

For equipment to be "digital ready" it must be able to handle overdrive without "breaking up" or grossly distorting the sound. With one exception all power amplifiers today are incapable of accepting 10 decibels of overdrive without gross distortion. Some amplifiers totally collapse under this punishment. McIntosh has devised a new test which shows the spectral fidelity of amplifiers under stress.

SPECTRAL FIDELITY is one of the most meaningful characteristics of an amplifier. The harmonic distortion and the two tone intermodulation measurements are important criteria in predicting the sonic performance. However, to obtain better correlation with human hearing response, we need to know not only the energy in the distortion spectrum, but also the number of discords and their frequency spacing from the desired tones. This is what the Spectral Fidelity testing can do, enlarge the scope of the data and showing its meaning more fully.

In these oscillograms, you can see the difference in Spectral Fidelity when a McIntosh is stressed, and when other amplifiers are stressed.

1. The McIntosh stressed 10 dB above rated power.
2. A foreign amplifier stressed 10 dB above rated power.
3. An American manufactured amplifier which had to be tested "under-stressed" since it could not take 10 dB of overload.

The McIntosh shows only 3 distortion components, which are more than 44 and 50 dB down, roughly equivalent to 0.3% distortion. The other amplifier shows 17 discords, some of which are only 10 dB down, or 30% distortion, with many less than 30 dB down, or 3% distortion.

Note in the third oscillogram the complete failure of one of the popular American manufactured amplifiers. When 14 and 15 kHz are amplified at the same time, this amplifier shuts down by "motor boating".

It is no accident that McIntosh amplifiers sound better.

It is no accident that a McIntosh is a better investment.

- It sounds better
- It is more reliable
- It last longer
- Its resale value is the highest

If good enough will do, there are at least 100 answers for you. But if the best is what you need then there is only one real answer....

....the amplifier that in 40 years has outlived 60 others who have simply faded away.

## 24 SPECTRAL FIDELITY

**McIntosh<sup>®</sup>**

McINTOSH LABORATORY INC.  
2 CHAMBERS ST., BINGHAMTON, NY 13903-2699  
607-723-3512

The manufacturer disclaims all liability for the quality of  
McIntosh Laboratory products and assumes no liability  
for any damage, injury or loss resulting from the use  
of any of its products.  
Printed in U.S.A.

014529