

McIntosh
MC 2255

OWNER'S MANUAL

THE McINTOSH MC 2255 SOLID STATE STEREO POWER AMPLIFIER

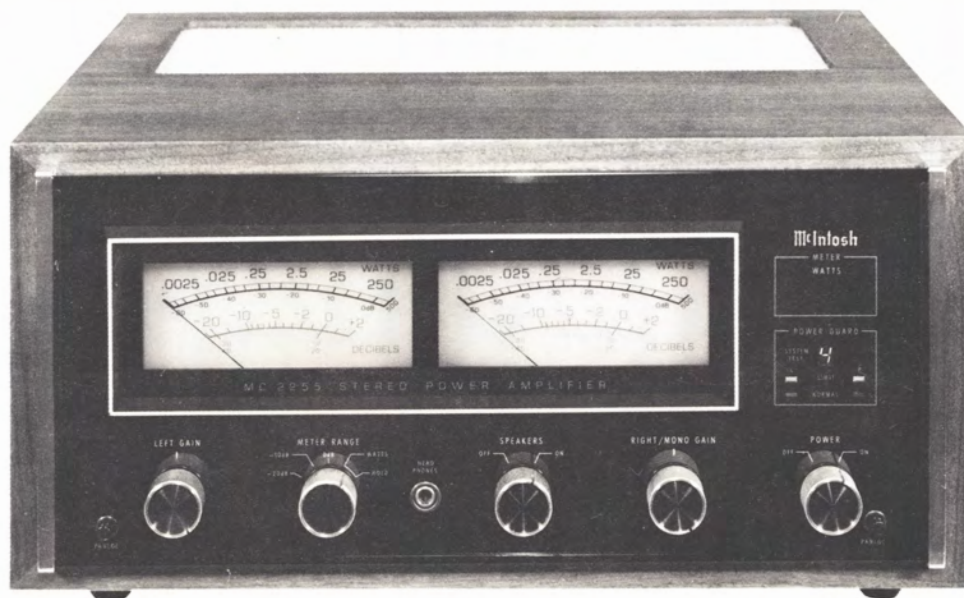

Reading Time: 31 Minutes

Price \$2.00

Your MC 2255 Stereo Power Amplifier will give you many years of pleasant and satisfactory performance. If you have any questions, please contact:

CUSTOMER SERVICE

McIntosh Laboratory Inc.
2 Chambers Street
Binghamton, New York 13903
Phone: 607-723-3512

**Take Advantage of 3 years
of Contract Service...
Fill in the Application NOW.**

Contents

SERVICE	1
INSTALLATION	2
HOW TO CONNECT	4
FRONT PANEL INFORMATION	9
REAR PANEL INFORMATION	11
PERFORMANCE LIMITS AND RATINGS	12
PERFORMANCE CHARTS	13
TECHNICAL DESCRIPTION	15
BLOCK DIAGRAM	17

McINTOSH THREE YEAR SERVICE CONTRACT

An application for A THREE YEAR SERVICE CONTRACT is included with this manual. The terms of the contract are:

1. McIntosh will provide all parts, materials and labor needed to return the measured performance of the instrument to the original performance limits. The SERVICE CONTRACT does not cover any shipping costs to and from the authorized service agency or the factory.
2. Any McIntosh authorized service agency will repair McIntosh instruments at normal service rates. To receive service under the terms of the SERVICE CONTRACT, the SERVICE CONTRACT CERTIFICATE must be presented when the instrument is taken to the service agency.
3. Always have service done by a McIntosh authorized service agency. If the instrument is modified or damaged as a result of unauthorized repair, the SERVICE CONTRACT will be cancelled. Damage by improper use or mishandling is not covered by the SERVICE CONTRACT.
4. The SERVICE CONTRACT is issued to you as the original purchaser. To protect you from misrepresentation, this contract cannot be transferred to a second owner.
5. To receive the SERVICE CONTRACT, your purchase must be made from a McIntosh franchised dealer.
6. Your completely filled in application for the SERVICE CONTRACT must be post-marked within 30 days of the date of purchase of the instrument.
7. To receive the SERVICE CONTRACT, all information on the application must be filled in. The SERVICE CONTRACT will be issued when the completely filled in application is received by McIntosh Laboratory Incorporated in Binghamton, New York.
8. Units in operation outside the United States and Canada are not covered by the McIntosh Factory Service Contract, irrespective of the place of purchase. Nor are units acquired outside the U.S.A. and Canada, the purchasers of which should consult with their dealer to ascertain what, if any, service contract or warranty may be available locally.

Installation

The PANLOC system of installing equipment conveniently and securely is a direct result of McIntosh research. By depressing the two PANLOC buttons on the front panel, the instrument either can be locked firmly in place or it can be unlocked so that the chassis can slide forward, giving you easy access to the top and rear panels.

The trouble-free life of an electronic instrument is greatly extended by providing sufficient ventilation to prevent the build-up of high internal temperatures that cause deterioration. Allow enough clearance so that cool air can enter at the bottom of the cabinet and be vented from the top. With adequate ventila-

tion the instrument can be mounted in any position. The recommended minimum space for installation is 15 inches (38.1 cm) deep, 17 inches (43.2 cm) wide, and 8 inches (20.3 cm) high.

To install the instrument in a McIntosh cabinet, follow the instructions that are enclosed with the cabinet. For any other type of installation, follow these instructions:

1. Open the carton and remove the PANLOC brackets, hardware package, and mounting template. Remove the MC 2255 from its plastic bag and place it upside down on the shipping pallet, then unscrew the four plastic feet from the bottom of the chassis.

2. Mark the cabinet panel
Place the mounting template in the position on the cabinet panel where the instrument is to be installed, and tape it in place. The broken lines that represent the outline of the rectangular cutout also represent the outside dimensions of the chassis. Make sure these lines clear shelves, partitions, or any equipment. With the template in place, first mark the six A and B holes and the four small holes that locate the corners of the cutout. Then, join the four corner markings with pencil lines using the edge of the template as a straight edge.

3. Drill Holes
Use a drill with a 3/16 inch bit held perpendicular to the panel and drill the six A and B holes. Then, using a drill bit slightly wider than the tip of your saw blade, drill one hole at each of two diagonally opposite corners. The holes should barely touch the inside edge of the penciled outline. **Before taking the next step, make sure that the six A and B holes have been drilled.**

4. Saw the Panel Cutout
Saw carefully on the inside of the penciled lines. First make the two long cuts and then the two short cuts. After the rectangular opening has been cut out, use a file to square the corners and smooth any irregularities in the cut edges.

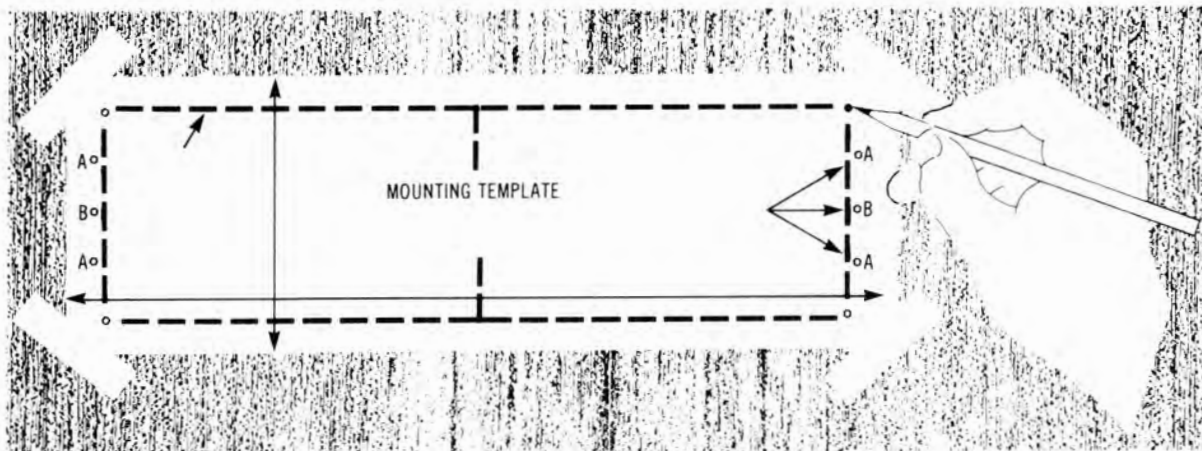

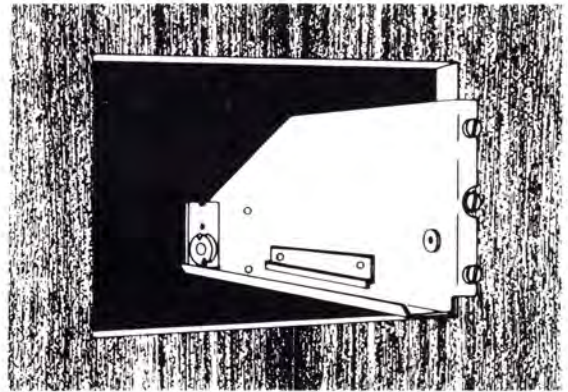
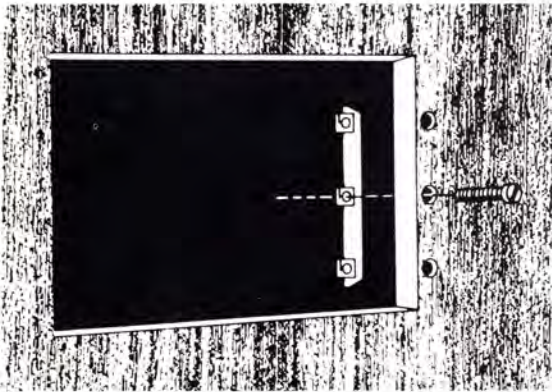

5. Install the Mounting Strips

In the hardware package you will find two mounting strips and two sets of machine screws. For panels that are less than 1/2 inch thick, use the 3/4 inch screws; for panels that are more than 1/2 inch thick, use the 1 1/4 inch screws.

Starting at the right-hand side of the panel, insert a screw of proper length into the center hole in the panel, marked B on the template. On the back of the panel, align a mounting strip with the holes in the panel and tighten the screw until the screwhead is pulled slightly into the wood.

Repeat this procedure to attach the mounting strip to the left side of the panel.

6. Attach the PANLOC Brackets

Using two screws of proper length in the A holes on each side, attach the PANLOC brackets to the cabinet panel; the short flange is mounted against the front (face) of the cabinet panel. The screws pass

through the PANLOC bracket flange, the cabinet panel, and then through the mounting strips previously mounted.

7. Install the Instrument

Guide the AC power cord through the panel opening to the back of the cabinet; then, slide the instrument into the opening carefully so that the rails on the bottom of each side of the chassis engage the tracks on the mounting brackets. Continue to slide the instrument into the cabinet until it is stopped by the adjust position latches. Press the latches inward, this permits the instrument to slide into the cabinet until its front panel is flush with the cabinet panel. Depress the PANLOC buttons at the lower left and right corners of the instrument panel to lock the unit firmly in the cabinet. Depressing the PANLOC buttons again will unlock the instrument so that it can slide forward to the adjust position; if you press inward on the adjust position latches then you can remove the instrument from the cabinet.

How to Connect



INPUT STEREO OPERATION

Use shielded cables to connect the signal from the preamplifier or signal source to the power amplifier. To minimize the possibility of hum the shielded cables should be run parallel to each other or loosely twisted together. Locate the cables away from speaker leads and AC power cords. All connections are made on the back panel of the MC 2255.

For stereo operation, the left output of the preamplifier should be plugged into the Left input jack of the power amplifier. The right output of the preamplifier should be plugged into the Right (Mono) input jack of the power amplifier.

In stereo operation the MODE SWITCH must be in the STEREO position.

MONOPHONIC OR SINGLE CHANNEL OPERATION

A shielded cable from the signal source is plugged into the Right (Mono) input jack of the MC 2255 only. The MODE SWITCH on the back panel of the amplifier must be placed in one of the MONO positions. In the MONO positions the output of the right channel input amplifier is fed to both left and right power amplifiers. The Left INPUT is disconnected. Only the signal fed into the Right (MONO) input will be amplified.

Be certain that the MC 2255 is never operated in the stereo mode with the outputs connected for monophonic operation. Should the MODE SWITCH be left in the STEREO position and the outputs remain strapped for a mono parallel load, one channel will attempt to drive the other which causes high circulating currents and overheating.

OUTPUT

Be certain the loudspeakers connected to the MC 2255 are capable of handling the power output of the amplifier.

Selection of the proper gauge wire to connect the loudspeakers preserves the quality of sound repro-

duction for which the loudspeakers have been designed. If undersize wire is used, resistance is added to the amplifier/loudspeaker combination which adversely affects the performance. Added resistance causes depreciation of damping characteristics, modification of frequency response and reduction in power output.

Use lamp cord or wire with similar insulation to connect the speakers to the amplifier. In all cases, the leads to and from the speaker should be twin conductor or twisted together. When using 8 ohm speakers and for the normally short distances of under 30 feet between the amplifier and speaker, # 18 wire or larger can be used. For distances over 30 feet use larger diameter wire. Select the correct size wire from the chart below. It is recommended that the DC resistance of the speaker leads be less than 5% of the speaker impedance. Resistance of the leads should be computed for the length of wire both to and from the speaker or speakers.

For multiple speaker operation, run separate leads from the amplifier to the speakers.

Wire Gauge	MAXIMUM WIRE LENGTHS			
	For 4 Ohm Load		For 8 Ohm Load	
	Feet	Meters	Feet	Meters
18	15	4.57	30	9.14
16	25	7.62	50	15.24
14	40	12.19	80	24.38
12	60	18.29	120	36.58
10	100	30.48	200	60.96

Wire lengths above represent the wire resistance equal to 5% of the speaker impedance.

STEREO OPERATION

Check the impedance of the speaker which is usually identified on the speaker itself or in the owner's manual. Connect a lead from the common terminal of the left speaker to the amplifier LEFT OUTPUT terminal strip COMMON screw. Connect

another lead from the other terminal of the loudspeaker to the left output terminal marked for the impedance of the speaker on the LEFT OUTPUT terminal strip. The right channel speaker is connected in the same manner to the RIGHT OUTPUT terminal strip.

When multiple speakers are to be connected to either or both outputs, the combined load impedance must be calculated. The load must be connected to the appropriate impedance tap. Use this table to aid in selecting the correct impedance match:

Load impedance in ohms	Connect for:
0.8 to 1.6	1 ohm output
1.6 to 3.2	2 ohm output
3.2 to 6.4	4 ohm output
6.4 and up	8 ohm output

If a load impedance is used that is lower than the output impedance tap, then reduced power and possible distortion will result. If a load impedance is used that is higher than the output impedance tap, then neither the signal nor the amplifier will be harmed but the power available is reduced.

FOR STEREO CONSTANT VOLTAGE OPERATION:

For output voltage of	Connect for:
25 volts	4 ohms

MONOPHONIC OR SINGLE CHANNEL OPERATION

When the MC 2255 is used as a monophonic or single channel power amplifier the two channels are combined to produce output up to 500 watts. The outputs must be connected as described below.

For monophonic operation using the MONO BRIDGE mode, output impedances of 2, 4, 8, and 16 ohms are accommodated. Output connections are made by connecting to the output terminals as listed below. Note that neither output terminal is at ground potential.

Load Impedance In Ohms	Connect – Speaker Lead To:	Connect + Speaker Lead To:
2	Left 1 Ohm Terminal	Right 1 Ohm Terminal
4	Left 2 Ohm Terminal	Right 2 Ohm Terminal
8	Left 4 Ohm Terminal	Right 4 Ohm Terminal
16	Left 8 Ohm Terminal	Right 8 Ohm Terminal

For monophonic operation using the MONO PARALLEL mode, output impedances of 1/2, 1, 2, and 4 ohms are accommodated. Connect as listed below. The common output terminal is at ground potential.

Load Impedance In Ohms	Connect – Speaker Lead To:	Connect + Speaker Lead To:
1/2	Either Left or Right Common Terminal	Both Left and Right 1 Ohm Terminals
1	Either Left or Right Common Terminal	Both Left and Right 2 Ohm Terminals
2	Either Left or Right Common Terminal	Both Left and Right 4 Ohm Terminals
4	Either Left or Right Common Terminal	Both Left and Right 8 Ohm Terminals

FOR MONOPHONIC CONSTANT VOLTAGE LINE OPERATION

For output voltage of	Connected for:
25 volts	2 ohm output (mono)

Be certain that the MC 2255 is never operated in the stereo mode with the outputs connected for monophonic operation. Should the MODE SWITCH be left in the STEREO position and the outputs remain strapped for a mono parallel load, one channel will attempt to drive the other which causes high circulating currents and overheating.

AC POWER

The MC 2255 operates on 120 volts 50/60 Hz. The auxiliary AC OUTLET on the MC 2255 is not fused or switched.

Stereophonic Connections

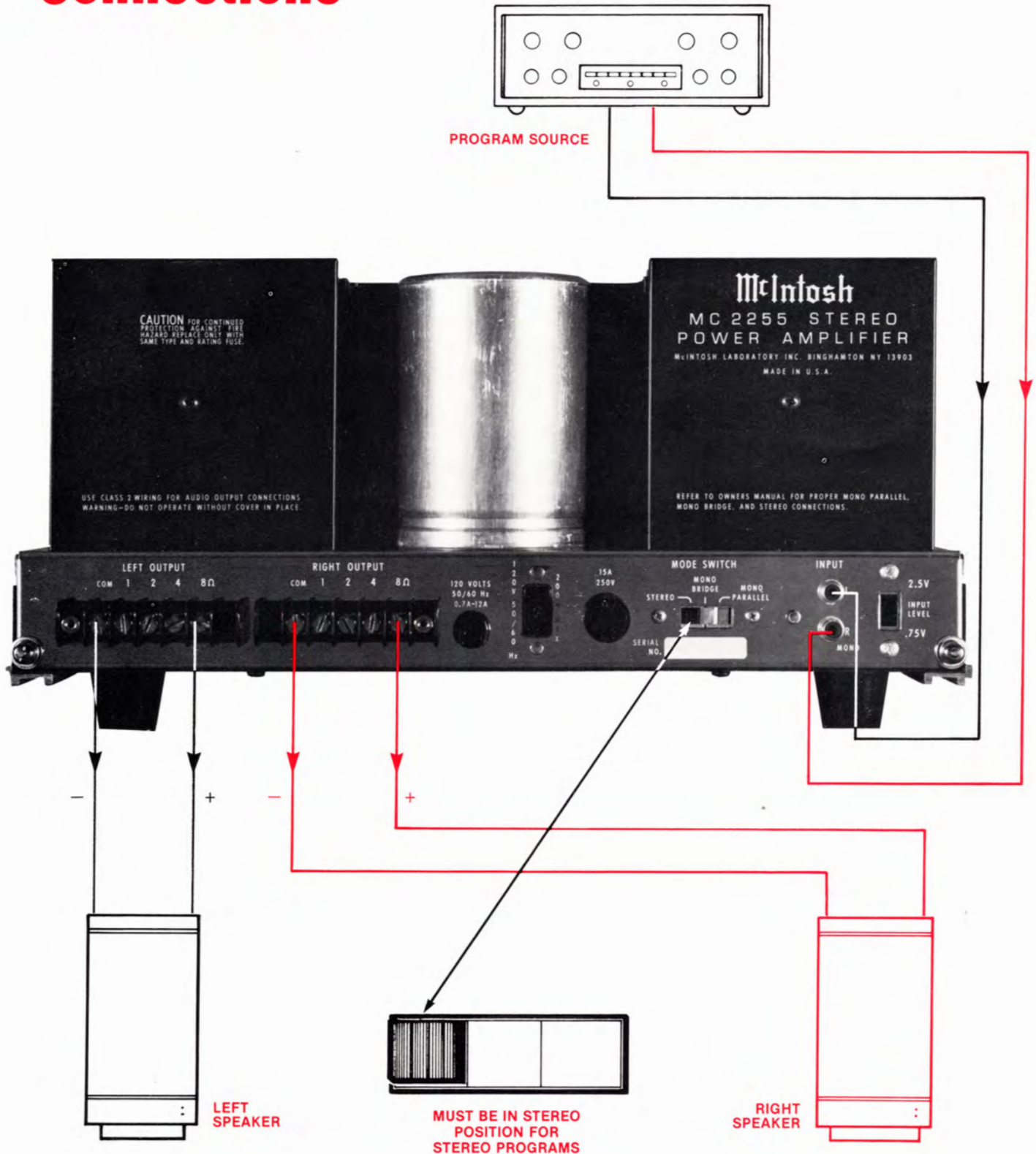

Mono-Bridge Connections

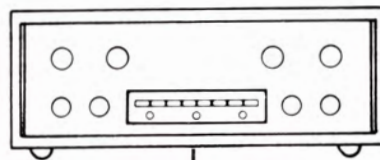

PROGRAM SOURCE

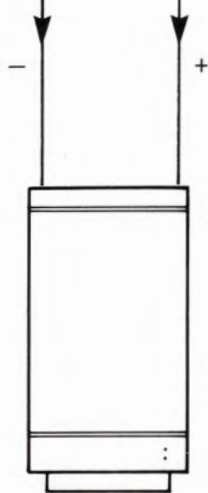
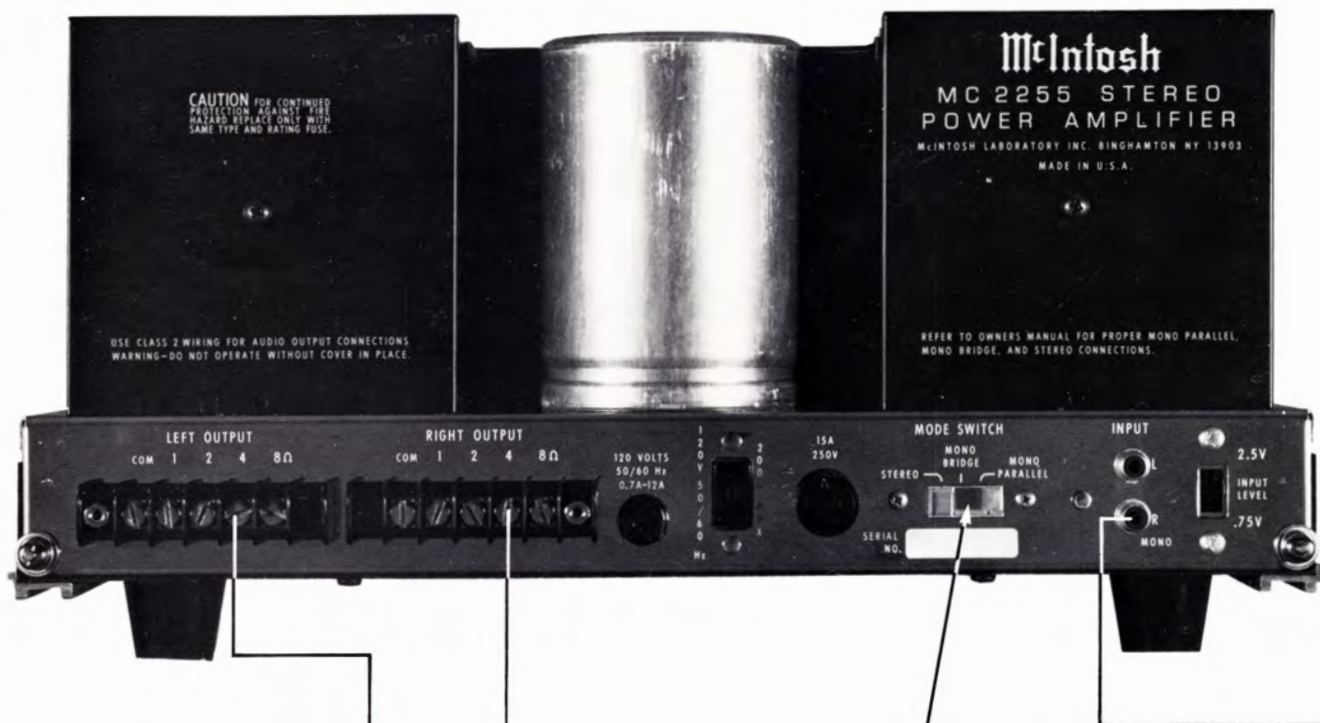

(CONNECTIONS FOR 8 OHM SPEAKER ILLUSTRATED)

SPEAKER



CONNECTIONS SHOWN FOR MONO WHEN MODE SWITCH IS IN THE MONO-BRIDGE POSITION

Mono-Parallel Connections

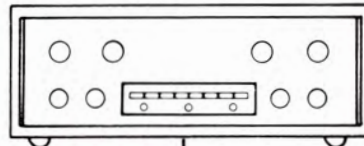

PROGRAM SOURCE

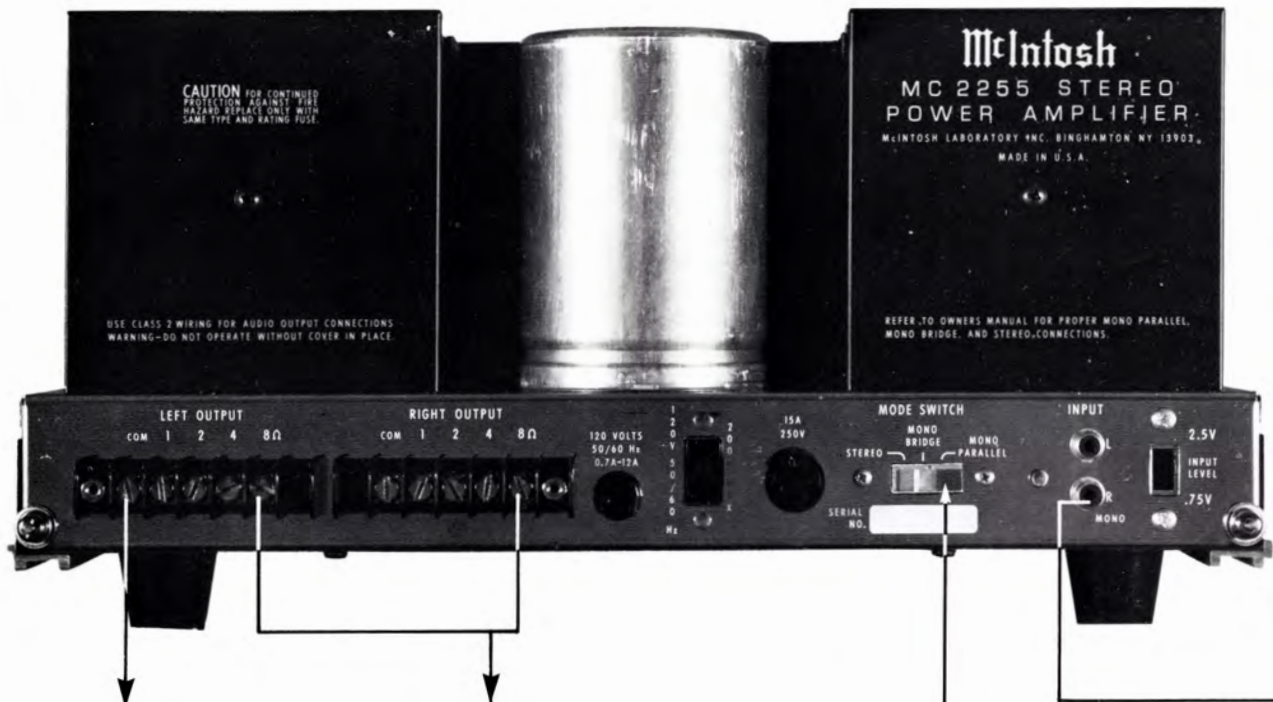

(CONNECTIONS FOR 4 OHM SPEAKER ILLUSTRATED)

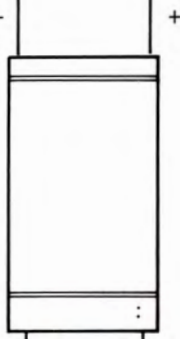

SPEAKER

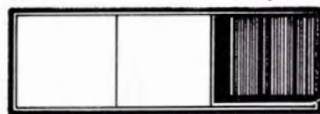

CONNECTIONS SHOWN FOR MONO WHEN MODE SWITCH IS IN THE MONO-PARALLEL POSITION



The Front Panel Controls and How to Use Them

METERS

Output power monitor meters indicate the output power of each channel. Each meter has two primary scales: WATTS and DECIBELS. When the METER RANGE switch is in one of the decibel (dB) positions, peak signal readings are indicated on the lower DECIBEL scale. When the METER RANGE switch is in the WATTS position, direct power in watts is read from the upper watts scale. The meters are calibrated to read average watts. The intermediate markings between the calibrations represent, beginning with 250 watts, 100 watts, 50 watts, the indicated 25 watts, 10 watts, 5 watts, the indicated 2.5 watts, 1 watt, .5 watt, the indicated 0.25 watt, 0.1 watt, 0.05 watt, the indicated 0.025 watt, 0.01 watt, 0.005 watt, the indicated 0.0025 watt, 0.001 watt and 0.0005 watt. Although the meter calibrations are in average watts for a sine wave signal, the meters electrically respond to signal peaks. The meters are voltage actuated and indicate power accurately when the amplifier is operated into rated output load impedances.

The meters respond to the peak output of each channel. Ordinary meters lack the capability of indicating the short interval information in a sound wave. The mass of the meter movement is too great to respond to the nearly instantaneous changes in

music program material. Short interval information can have a duration as short as half a thousandth of a second. Ordinarily, a meter pointer moving over its scale in such a short time would not be seen. McIntosh has developed circuits that drive the meters to respond to the short interval information in a sound wave to an accuracy of 90%. The electrical pulse that drives the meter pointer is time stretched long enough so that the peak position of the pointer can register in the persistence of vision characteristic of the retina of the human eye.

LEFT GAIN

The LEFT GAIN control adjusts the volume in the left channel to the desired listening level. Turn the control clockwise to increase the volume.

RIGHT/MONO GAIN

The RIGHT/MONO GAIN control adjusts the volume in the right channel to the desired listening level. Turn the control clockwise to increase the volume. When the output of MC 2255 is connected for monophonic operation and the rear panel MODE SWITCH is in the MONO position the volume is controlled by the RIGHT/MONO GAIN control only.

METER RANGE

The METER RANGE switch has five positions.

WATTS

In the WATTS position the meter's primary calibration is from .0025 watts (two and a half milliwatts), up to 250 watts, the rated power output of the MC 2255. The meter is calibrated for 500 watts at the right hand end of the meter scale. While the MC 2255 cannot reach this power level continuously, it is possible for short interval peaks to exceed, considerably, the 250 watt continuous rating.

HOLD

In the HOLD position, the meter indicates WATTS and locks to the highest power peak in a sequence of peaks. The meter will be driven to maximum power and electronically held there until a higher peak passes through the amplifier. If no further peaks are reached the meter needle will very slowly return to its rest position (decay rate: 6 dB per minute).

DECIBELS

In the other three positions of the METER RANGE switch the meters will indicate the output of each channel in DECIBELS relative to 250 watts or any other chosen reference.

0 dB In this position of the switch, if the amplifier delivers 250 average watts, the meter indicates 0 dB; at 125 average watts the meter indicates -3 dB. If the amplifier is overdriven to +2 dB the indicated output would be 396 watts.

-10 dB In this position of the switch, if the amplifier delivers 25 average watts, the meter indicates 0 dB; at 12.5 average watts the meter indicates -3 dB.

-20 dB In this position of the switch, if the amplifier delivers 2.5 average watts, the meter indicates 0 dB; at 1.25 average watts the meter indicates -3 dB.

HEADPHONES

The output of the front panel HEADPHONE jack has been designed to feed low impedance dynamic stereo headphones.

The HEADPHONE output is not affected by the SPEAKER switch.

SPEAKERS

OFF: The loudspeakers are turned off when the SPEAKER switch is in the OFF position. You can listen to headphones in private.

THE SPEAKER SWITCH MUST BE IN THE "ON" POSITION TO HEAR MUSIC FROM THE LOUDSPEAKERS.

ON: Music will be heard through the loudspeakers. Use this as the normal listening position.

POWER

The power switch turns the MC 2255 ON or OFF. The switch does not control the power outlet on the back panel. If you wish to control the AC power from a preamplifier control center leave the switch in the ON position. Be sure the AC cord of the MC 2255 is plugged into the controlled outlets on the rear of the preamplifier control center.

OFF: In the OFF position the AC power to the amplifier is turned off.

POWER GUARD

POWER GUARD assures that the MC 2255 cannot be overdriven, thus amplifier output clipping is eliminated. Clipping is caused when an amplifier is asked to produce more power output than it can deliver with low distortion. Amplifiers are capable of delivering large quantities of highly distorted power when they are driven to clipping. The extra energy content of the clipped signal will damage most speakers. McIntosh's Power Guard circuit protects your speakers from this kind of damage. The MC 2255 has a built in "waveform comparator" that compares the wave shape of the output signal to the input signal. If the disparity between the two signals, due to overdrive, exceeds 0.5% (equivalent to 0.5% total harmonic distortion) a red LIMIT indicator illuminates. With any further increase in distortion the Power Guard circuit operates to limit the amplifier input dynamically so that the amplifier cannot be overdriven. Power Guard eliminates amplifier output clipping. As long as the amplifier operates without overload the NORMAL indicator illuminates.



NEW AUTOMATIC TEST SYSTEM

The MC 2255 contains a new automatic test circuit. When AC line power is applied, an LED digit illuminates to indicate which test is being performed. Starting with the numeral 7, it makes the required measurement and verifies if it is within tolerance by lighting the "normal" Power Guard green lights. It then counts down to six, performs and verifies the next test, then five, four, three, etc. until it reaches "1" and then the speakers turn on. A "beep" tone is heard each time a test is performed. If a circuit should fail, the red "limit" lights will come on and the sequence will stop at that point. Speaker turn on will not occur until the fault has been corrected; thereby protecting your system from any further damage.

There are two user controls associated with the auto test circuit. They are located on the amplifier top panel. Two switches control the speed of the countdown (SLOW or FAST) and the presence of the beep tone (ON-OFF).



Rear Panel Information

MODE SWITCH

The MC 2255 will operate in three modes, Stereo, Mono Bridge, and Mono Parallel. The Mono modes differ in the loads they will drive and the connection sequence to the speaker terminals.

LEFT and RIGHT OUTPUT TERMINALS

For stereo operation, output impedances of 1, 2, 4 and 8 ohms have been provided on a secure, screw type barrier strip. For monophonic operation proper interconnection provides 0.5, 1, 2, 4, 8, and 16 ohms from the same barrier strips. See page 5 for connecting instructions.

INPUT JACKS

In the stereo mode of operation, both input jacks accept signal. In the mono mode of operation only the Right (MONO) channel input jack accepts signal and the Left channel input jack is disconnected.

INPUT LEVEL

The Input sensitivity of the MC 2255 is 0.75 volts or 2.5 V depending on the position of the INPUT LEVEL switch. All McIntosh preamplifiers have been designed to deliver 2.5 volts output with rated input. For the best signal to noise ratio when using McIntosh source equipment, place the INPUT LEVEL switch in the 2.5 V position and the front panel LEFT and

RIGHT/MONO GAIN controls in the fully clockwise position. If more gain is desired the 0.75 V position may be used. For source equipment other than McIntosh, set the switch in the position nearest to the stated output rating of the source equipment.

AC POWER

The input to the MC 2255 is 120 volts 50/60 Hz at up to 12 amps. The primary circuit is protected by a 15 Amp Fuse.

Performance Limits

PERFORMANCE GUARANTEE

Performance Limits are the maximum deviation from perfection permitted for a McIntosh instrument. We promise you the MC 2255 you buy must be capable of performance at or exceeding these limits or you get your money back. McIntosh is the only manufacturer that makes this guarantee.

PERFORMANCE

McIntosh audio power ratings are in accordance with the Federal Trade Commission Regulation of November 4, 1974 concerning power output claims for amplifiers used in home entertainment products.

POWER OUTPUT

STEREO

250 watts minimum sine wave continuous average power output, per channel, both channels operating into 1 ohm, 2 ohms, 4 ohms, or 8 ohms load impedance, which is:

15.8 volts RMS across 1 ohm
22.4 volts RMS across 2 ohms
31.6 volts RMS across 4 ohms
44.7 volts RMS across 8 ohms

MONO

500 watts minimum sine wave continuous average power output into 0.5 ohm, 1 ohm, 2 ohms, 4 ohms, 8 ohms, or 16 ohms load impedance, which is:

15.8 volts RMS across 0.5 ohm
22.4 volts RMS across 1 ohm
31.6 volts RMS across 2 ohms
44.7 volts RMS across 4 ohms
63.2 volts RMS across 8 ohms
89.4 volts RMS across 16 ohms

OUTPUT LOAD IMPEDANCE

STEREO

1 ohm, 2 ohms, 4 ohms, and 8 ohms; separate terminals are provided for each output.

MONO-PARALLEL

0.5 ohm, 1 ohm, 2 ohms, and 4 ohms; obtained by connecting together the appropriate terminals of both channels.

MONO-BRIDGED

2 ohms, 4 ohms, 8 ohms, or 16 ohms, balanced to common connections.

RATED POWER BAND

20 Hz to 20,000 Hz

TOTAL HARMONIC DISTORTION

STEREO

0.02% maximum harmonic distortion at any power level from 250 milliwatts to 250 watts per channel from 20 Hz to 20,000 Hz, both channels operating.

MONO

0.02% maximum harmonic distortion at any power

level from 250 milliwatts to 500 watts from 20 Hz to 20,000 Hz.

INTERMODULATION DISTORTION

STEREO

0.02% maximum if instantaneous peak power output is 500 watts or less per channel with both channels operating for any combination of frequencies, 20 Hz to 20,000 Hz.

MONO

0.02% maximum if instantaneous peak power output is 1000 watts or less for any combination of frequencies, 20 Hz to 20,000 Hz.

FREQUENCY RESPONSE (at one watt output)

20 Hz to 20,000 Hz +0 -0.25 dB.
10 Hz to 100,000 Hz +0.25 -1 dB.

NOISE AND HUM

95 dB below rated output.

RATINGS

DAMPING FACTOR

Greater than 30

INPUT IMPEDANCE

50,000 ohms.

INPUT SENSITIVITY

Switchable: 0.75 volt or 2.5 volts—level control provided for higher input voltages.

POWER GUARD

Clipping is prevented and THD does not exceed 2% with up to 20 dB overdrive at 1 KHz.

GENERAL INFORMATION

POWER REQUIREMENTS

120 volts 50/60 Hz 0.7 to 12 amps.

SEMICONDUCTOR COMPLEMENT

85 silicon transistors
47 silicon rectifiers and diodes
14 integrated circuits

Performance Charts

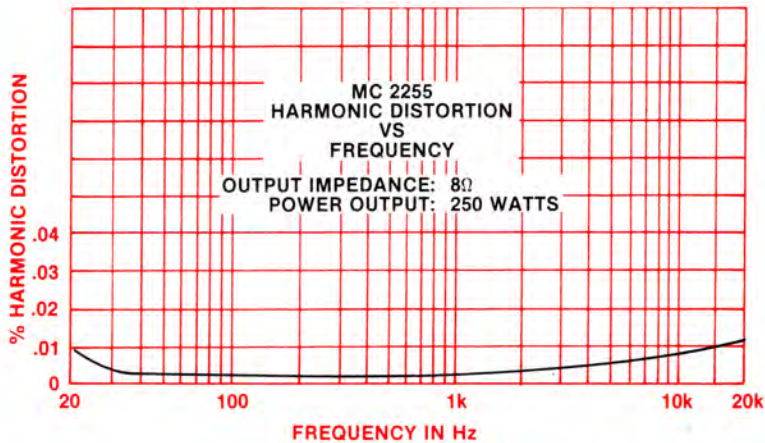
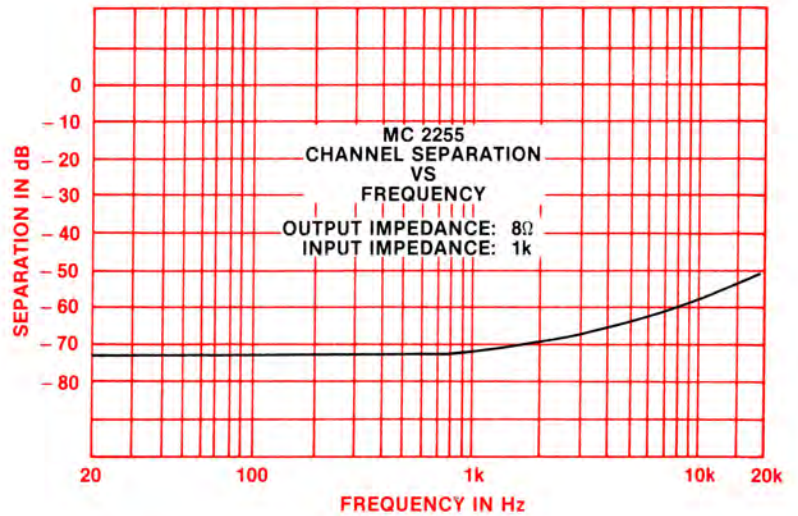
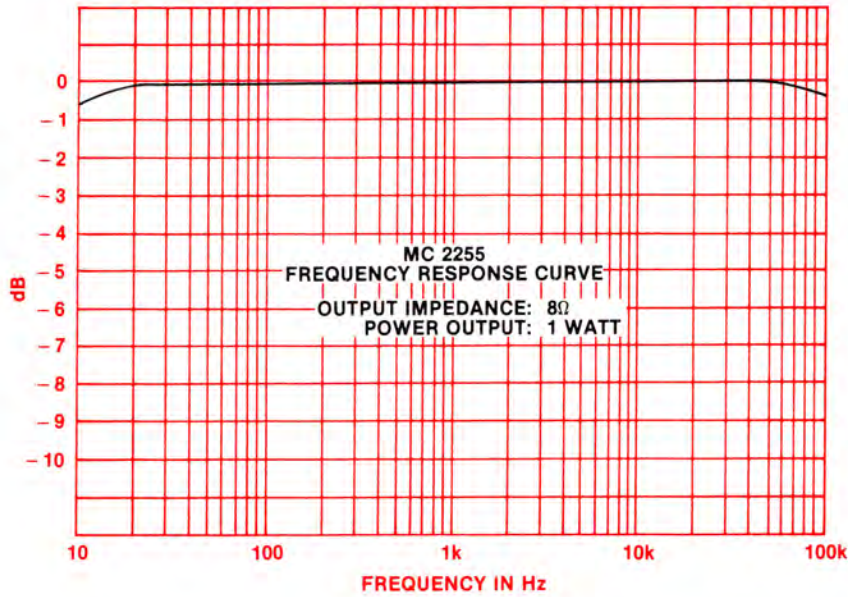

PERFORMANCE CHARTS ARE FOR ONE STEREO CHANNEL WITH BOTH CHANNELS OPERATING. MONO OPERATION IS IDENTICAL EXCEPT POWER IS DOUBLED FOR THE SINGLE MONO OUTPUT.

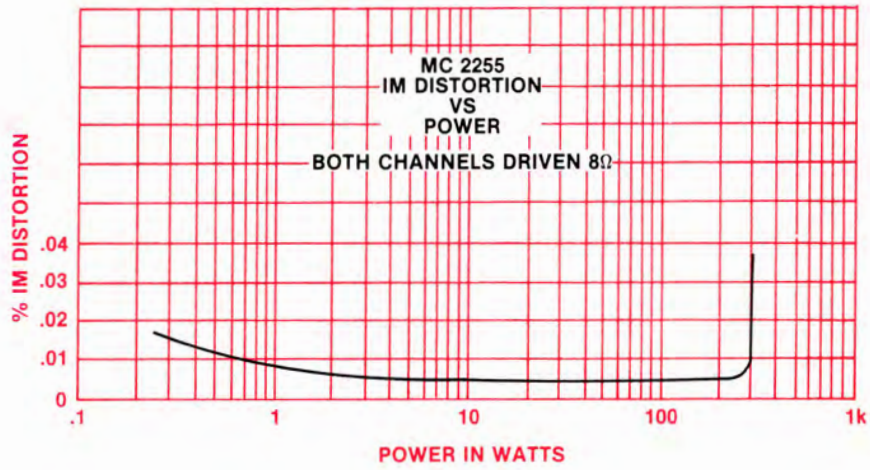
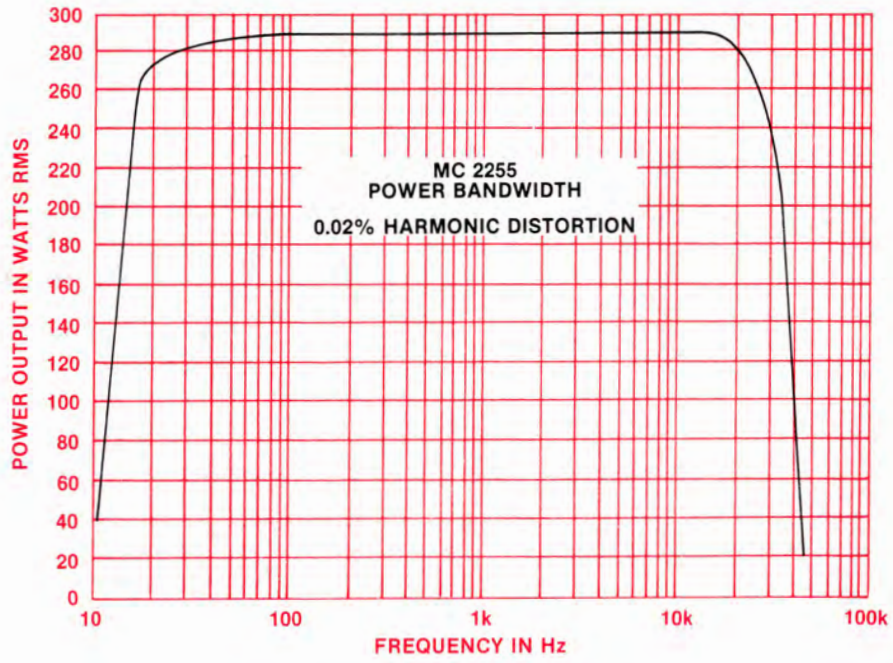

Technical Description

INPUT AMPLIFIER

Each channel input contains a complete seven transistor low power amplifier. A differential transistor pair provides high input impedance and low noise. The differential signals are combined in a current mirror circuit which drives a class A amplifier stage. The following output stage is driven by a complimentary pair of transistors with class AB biasing. The output signal drives the metering circuit, headphone jack, and the high power output amplifier. This discrete transistor amplifier design was selected for low noise, low distortion, adequate power output capability to drive headphones, and freedom from turn on and turn off transients.

The INPUT LEVEL selector and GAIN controls are passive attenuators which precede the input amplifier circuitry. Therefore, the input system to the amplifier cannot be overloaded when the controls are correctly set.

In the MONO mode of operation the input signal feeds only the right input amplifier via the RIGHT/MONO GAIN control. The output of the right input amplifier feeds both output power amplifier sections. When MONO BRIDGE MODE is selected the left channel input amplifier is used as a phase inverter before the left output amplifier. The output channels are therefore 180° out of phase with respect to each other which is the correct arrangement for bridge output connections. When MONO PARALLEL MODE is selected the channels operate in phase. The channels, of course, also operate in phase for the STEREO MODE.

OUTPUT POWER AMPLIFIER

The power amplifier inputs are coupled to the input amplifier outputs through an electronic switch. The switch eliminates turn-on and turn-off transients and is used for speaker switching. A junction FET and LED/light dependent resistor network make up the switch. This combination allows the lowest possible distortion when the amplifier is on and high isolation when the output power amplifier is off. The control signal to the switch is held off for the auto test countdown time. Therefore, transients that may come into the amplifier from source equipment will not be amplified or reach the loudspeaker. Since the HEADPHONE output and meters are powered by the input amplifier, their operation is not affected by the SPEAKER switch or turn on delay system.

The first stage of the output power amplifier is a differential transistor pair biased for best linearity. The offset to the differential pair is adjustable. Correct adjustment allows the lowest possible distortion

at low frequencies. A current mirror circuit combines the differential outputs into one signal which is then amplified by a following class A voltage amplifier. Both the differential transistors and the voltage amplifier are supplied by active current sources. The results are lower distortion and cleaner turn on characteristics.

The driver stage consisting of a complimentary pair of power transistors biased class AB follow the voltage amplifier. Next, three complimentary pairs of rugged power transistors make up the power output stage. All power transistors are mounted on conservatively sized anodized aluminum heat sinks. Because of a unique connection of the bias network, the output transistors operate class B and exhibit no crossover distortion often associated with class B operation. The heat sinks, therefore remain cool when there is no output.

The turn-on and turn-off characteristics of the Power Amplifier are smooth and silent. No noisy relay is required to disconnect the loudspeakers during turn-on time. Relays can cause noise and increased distortion if the contacts aren't perfectly clean.

The amplifier output signal is fed to the output terminals through the output autotransformer. The McIntosh designed interleaved multifilar wound autotransformer is used to properly match the amplifier to stereo output load taps for 1, 2, 4 and 8 ohms. The MC 2255 will deliver full power over the entire audio frequency range at any of these impedances. The autotransformer also protects speakers from damage in the event of amplifier failure. Should a direct current component appear in the output it is shunted by the autotransformer and DC cannot damage the speaker.

A McIntosh patented Sentry Monitoring circuit constantly monitors the output signal and instantly reacts to prevent overload of the output transistors. At signal levels up to rated output this circuit has high impedance and has no effect upon the output. If the power output exceeds design maximum, the Sentry Monitoring circuit operates to limit the signal to the output transistors. In the event of a short circuit across the amplifier output or severe impedance mismatch the Sentry Monitoring circuit will protect the output transistors from failure. Both positive and negative halves of the output signal are monitored and protected independently.

POWER GUARD PROTECTION CIRCUIT

The McIntosh patented Power Guard circuit eliminates amplifier clipping due to overdrive. The

circuit also illuminates red LIMIT indicator lamps when the amplifier is driven beyond its maximum output capacity. Power Guard prevents loudspeaker damage and eliminates harsh output distortion caused by amplifier clipping.

The Power Guard circuit consists of a waveform comparator which monitors the wave shape of the amplifier input and output signals. Normally there is no disparity between these signals and the comparator produces no output. When the amplifier is driven beyond its maximum power capacity a difference will develop. If the disparity exceeds 0.5% (equivalent to 0.5% total harmonic distortion) the comparator output causes the red LIMIT indicators to light. If there is a further increase in the disparity the comparator output controls an electronic attenuator at the amplifier input to reduce the amplifier gain, thus holding the amplifier output to its maximum undistorted value regardless of the degree of overdrive to the amplifier. The amplifier may be overdriven by 20 dB before the output distortion exceeds 2%.

The comparator is an especially compensated operational amplifier integrated circuit. Its output is detected by a full wave bridge that feeds signals to the control circuitry for the LIMIT and NORMAL indicators and to the electronic attenuator at the amplifier input. The attenuator is a light emitting diode/light dependent resistor network selected especially for its low distortion and time constant characteristics.

SYSTEM TEST CIRCUIT

When AC line power is applied to the MC 2255 the System Test circuit functions to verify operating potentials at 7 test locations within the amplifier. Upon applying power a digital display lights with the number 7. The digit is driven by a counter that steps down at a 1 second or .4 second rate. Each time the digit changes electronic switches select the outputs of various voltage comparators connected to test points in the amplifier. If voltages are normal the green NORMAL Power Guard indicator lights, there is an audible beep produced by an internal sounder, and the digit decrements to the next test number. When the count passes number 1 the loudspeakers connect and the display blanks off. If a fault condition exists the counter stops. The digit displayed indicates the circuit at fault. Servicing the amplifier is thereby simplified.

The test circuit uses logic counter, BCD decoder, lamp driver, and voltage comparator integrated circuits.

METER CIRCUIT

The meter circuit has three basic sections: a logarithmic amplifier, a full wave rectifier, and a DC amplifier. In the WATTS ranges, the logarithmic amplifier is used. In the DECIBEL ranges, the signal bypasses

this amplifier and goes directly to the full wave rectifiers through an attenuator which is controlled by the METER RANGE switch.

The logarithmic amplifier consists of a high gain operational amplifier with a bipolar connected silicon diode pair as feedback elements. These diodes have a uniform logarithmic characteristic over an 80 dB range. Only 60 dB of this logarithmic range is used in the MC 2255.

The full wave rectifier circuit uses an operational amplifier with silicon diode feedback networks. This amplified diode circuit has nearly perfect rectification characteristics. One rectifier detects only positive signals. The other responds only to negative signals and produces a positive output. The outputs of the rectifiers are combined at the operational amplifier output, so the highest signal, either positive or negative, is the one that is indicated by the meters. Gate diodes are used to charge a low leakage capacitor which attains and holds a charge during signal peaks. The operational amplifier provides a large amount of current so the capacitor can charge suddenly. The charge on the peak holding capacitor is amplified in a two transistor DC amplifier which is used to drive the meter. From the output of this amplifier there is a DC feedback network that connects back to the detector to assure excellent overall linearity and frequency response. The current drive to the meters has a peaking capacitor to accelerate the upscale response of the meter needle. The meters also have a parallel shunt resistor to correctly damp their action. In the WATTS mode the discharge of the peak holding capacitor is controlled by a resistor current source. In WATTS HOLD, the resistor is disconnected so the peak reading is retained. The rate of decay is about 6 dB per minute.

POWER SUPPLY

The power supply is a conventional full wave bridge rectifier arrangement providing plus and minus 50 volts DC. Electronic regulators step down and regulate plus and minus 15 volt sources for low level circuits and plus 5 volts for the logic circuits. Thermistors are used in the power transformer primary circuit to limit the turn-on current.



Block Diagram

McINTOSH MC 2255 STEREO POWER AMPLIFIER

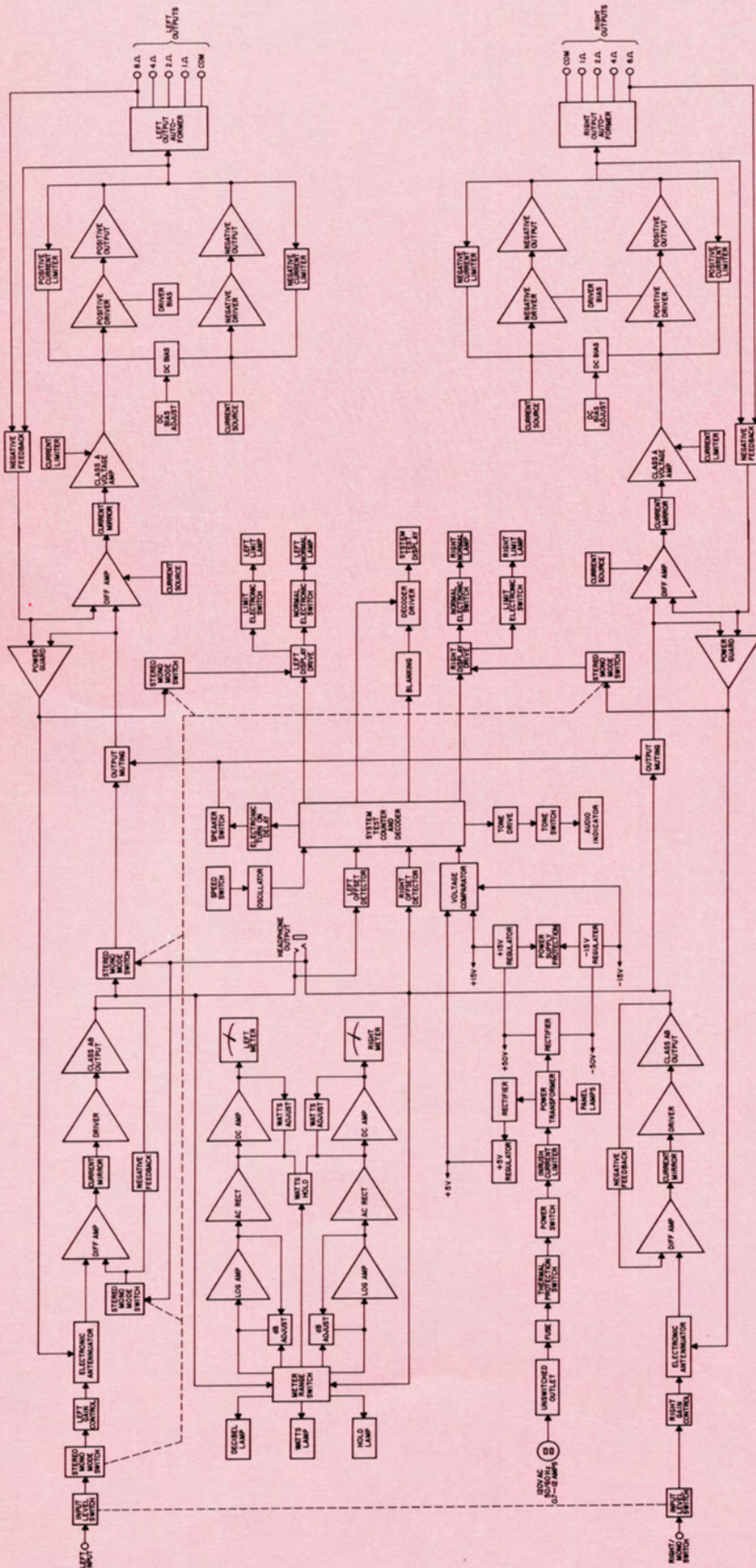

McIntosh

**McINTOSH LABORATORY INC.
2 CHAMBERS ST., BINGHAMTON, N.Y. 13903
607-723-3512**

The continuous improvement of its products is the policy of
McIntosh Laboratory Incorporated who reserve the right to
improve design without notice.

Printed in U.S.A.