



MC7108



## Thank You, Please Take A Moment, Customer Service and Table of Contents

### Thank You

For your decision to own this McIntosh MC7108 Eight Channel Power Amplifier ranks you at the very top among discriminating music listeners. You now have "The Best." The McIntosh dedication to "Quality," is assurance that you will receive many years of musical enjoyment from this unit.

Please take a short time to read the information in this manual. We want you to be as familiar as possible with all the features and functions of your new McIntosh MC7108. This will ensure that you receive all the performance benefits this equipment can offer you, and that it will become a highly valued part of your home entertainment system.

### Please Take A Moment

The serial number, purchase date and McIntosh dealer name are important to you for possible insurance claim or future service. The serial number is located on the rear panel of the equipment. The spaces below have been provided for you to record that information:

**Serial Number:** \_\_\_\_\_

**Purchase Date:** \_\_\_\_\_

**Dealer Name:** \_\_\_\_\_

### Customer Service

If at any time you have questions about your McIntosh MC7108 Eight Channel Power Amplifier, contact your McIntosh dealer. Your dealer is familiar with your McIntosh equipment as well as other brands that may be included in your system and is best qualified to help you.

If it is determined that your MC7108 is in need of repair, you can return it to your dealer or you can return it to McIntosh Laboratory. Contact the McIntosh Repair Department for assistance at.

McIntosh Laboratory, Inc.  
2 Chambers Street  
Binghamton, New York 13903  
Phone: 607-723-3512  
FAX: 607-724-0549

Copyright 1998 © by McIntosh Laboratory, Inc.

### Table of Contents

Thank You .....	2
Please Take a Moment .....	2
Customer Service .....	2
Table of Contents .....	2
Safety Instructions .....	3
Introduction .....	4
Performance Features .....	4
Installation .....	5
Rear Panel Controls and Connections .....	6
How to Connect .....	7
Front Panel Displays and Controls .....	8
How to Operate .....	9
Specifications .....	10
Packing Instruction .....	11

#### NOTES:

1. *Connecting Cables and Connectors are available from the McIntosh Parts Department:*
  - Data and Power Control Cable Part No. 170-202**  
Six foot, shielded 2 conductor, with 1/8 inch stereo mini phone plugs on each end.
  - Control Center to Multi Channel Power Amplifier Cable Part No. 170-631**  
Six foot, DB25, shielded, straight through, 25 conductor male-to-female cable.
  - Multizone Control System to Multi Channel Power Amplifier Cable Part No. 170-147**  
Six foot, 7Pin DIN, shielded, male-to-male cable.
2. *For additional connection information, refer to the owner's manual(s) for any component(s) connected to the MC7108 Amplifier.*
3. *There is a built-in turn on delay which will mute the speaker outputs for approximately two seconds when the amplifier is turned on.*
4. *It is very important that loudspeaker cables of adequate size be used in your music system, to ensure that there will be no power loss or heating. Cable size is specified in Gauge numbers or AWG, (American Wire Gauge). The smaller the Gauge number, the larger the wire size:*
  - If your loudspeaker cables are 25 feet (7.62m) or less, use at least 18 Gauge (AWG) wire size or larger.*
  - If your loudspeaker cables are 50 feet (38.1m) or less, use at least 16 Gauge (AWG) wire size or larger.*
  - If your loudspeaker cables are 100 feet (76.2m) or less, use at least 14 Gauge (AWG) wire size or larger.*

### IMPORTANT SAFETY INSTRUCTIONS!

**PLEASE READ THEM BEFORE OPERATING THIS EQUIPMENT.**



**WARNING SHOCK HAZARD - DO NOT OPEN.**



**AVIS RISQUE DE CHOC - NE PAS OUVRIR.**

**CAUTION**  
RISK OF ELECTRIC SHOCK  
DO NOT OPEN

**ATTENTION**  
DANGER D'ELECTROCUTION  
NE PAS OUVRIR

**NO USER-SERVICEABLE PARTS INSIDE. REFER SERVICING TO QUALIFIED PERSONNEL**

#### General:

1. Read all the safety and operating instructions, contained in this owner's manual, before operating this equipment.
2. Retain this owner's manual for future reference about safety and operating instructions.
3. Adhere to all warnings and operating instructions.
4. Follow all operating and use instructions.
5. **Warning: To reduce risk of fire or electrical shock, do not expose this equipment to rain or moisture. This unit is capable of producing high sound pressure levels. Continued exposure to high sound pressure levels can cause permanent hearing impairment or loss. User caution is advised and ear protection is recommended when playing at high volumes.**
6. **Caution: to prevent electrical shock do not use this (polarized) plug with an extension cord, receptacle or other outlet unless the blades can be fully inserted to prevent blade exposure.**  
**Attention: pour prevenir les chocs electriques pas utiliser cette fiche polarisee avec un prolongateur, une prise de courant ou un autre sortie de courant, sauf si les lames peuvent etre inserees afond ans en laisser aucune partie a decouvert.**
7. For added protection for this product during a lightning storm, or when it is left unattended and unused for long periods of time, unplug it from the wall outlet and disconnect the antenna or cable system. This will prevent damage to the product due to lightning or power line surges.
8. Do not use attachments not recommended in this owner's manual as they may cause hazards.

#### Installation:

9. Locate the equipment for proper ventilation. For example, the equipment should not be placed on a bed, sofa, rug, or similar surface that may block ventilation openings; or, placed in a built-in installation, such as a bookcase or cabinet, that may impede the flow of air through the ventilation openings.
10. Locate the equipment away from heat sources such as radiators, heat registers, stoves, or other appliance (including amplifiers) that produce heat.
11. Mount the equipment in a wall or cabinet only as described in this owner's manual
12. Do not use this equipment near water; for example, near a bathtub, washbowl, kitchen sink, laundry tub, in a wet basement or near a swimming pool, etc.
13. Do not place this product on an unstable cart, stand, tripod, bracket, or table. The equipment may fall, causing serious injury to a person, and serious damage to the product.

#### Connection:

14. Connect this equipment only to the type of AC power source as marked on the unit.
15. Route AC power cords so that they are not likely to be walked on or pinched by items placed upon or against them, paying particular attention to cords at plugs, convenience receptacles, and the point where they exit from the instrument.
16. Do not defeat the inherent design features of the polarized plug. Non-polarized line cord adapters will defeat the safety provided by the polarized AC plug. If the plug should fail to fit, contact your electrician to replace your obsolete outlet. Do not defeat the safety purpose of the grounding-type plug.
17. Do not overload wall outlets, extension cords or integral convenience receptacles as this can result in a risk of fire or electric shock.

#### Care of Equipment:

18. Clean the instrument by dusting with a dry cloth. Unplug this equipment from the wall outlet and clean the panel with a cloth moistened with a window cleaner. Do not use liquid cleaners or aerosol cleaners.
19. Do not permit objects of any kind to be pushed and/or fall into the equipment through enclosure openings.



## Safety Instructions con't, Introduction and Performance Features

Never spill liquids into the equipment through enclosure openings.

20. Unplug the power cord from the AC power outlet when left unused for a long period of time.

### Repair of Equipment:

21. Unplug this equipment from the wall outlet and refer servicing to a qualified service personnel under the following conditions:
  - A. The AC power cord or the plug has been damaged.
  - B. Objects have fallen, or liquid has been spilled into the equipment.
  - C. The equipment has been exposed to rain or water.
  - D. The equipment does not operate normally by following the operating instructions contained within this owner's manual. Adjust only those controls that are covered by the operating instructions, as an improper adjustment of other controls may result in damage and will often require extensive work by a qualified technician to restore the product to its normal operation.
  - E. The equipment has been dropped or damaged in any way.
  - F. The equipment exhibits a distinct change in performance - this indicates a need for service.
22. Do not attempt to service beyond that described in the operating instructions. All other service should be referred to qualified service personnel.
23. When replacement parts are required, be sure the service technician has used replacement parts specified by McIntosh or have the same characteristics as the original part. Unauthorized substitutions may result in fire, electric shock, or other hazards.
24. Upon completion of any service or repairs to this product, ask the service technician to perform safety checks to determine that the product is in proper operating condition.

### Introduction

Eight 40 watt McIntosh amplifier channels in one convenient package make the MC7108 an ideal amplifier for a multizone system. With the ability to bridge a pair of channels for 100 watts output allows the MC7108 to be configured in different operating modes to fit a wide range of uses where a multi-channel amplifier is required.

### Performance Features

#### • Power Output

The MC7108 consists of eight separate power amplifier channels, each capable of 40 watts into 4 ohm speakers with less than 0.005% distortion. This is 320 watts of McIntosh power in a single package.

#### • Power Guard

All eight channels include the patented McIntosh Power Guard circuit that prevents the amplifier from being overdriven into clipping with its harsh distorted sound that can also damage your valuable loudspeakers.

#### • Sentry Monitor

McIntosh Sentry Monitor power output stage protection circuits are present on all eight channels to ensure the MC7108 will have a long and trouble free operating life

#### • Thermal Protection

Built-in thermal protection circuits guard against overheating which could shorten the normal long life expectancy of your McIntosh power amplifier.

#### • Direct Current Protection

Direct Current sensing circuits on each channel provide extra protection for your valuable loudspeakers.

#### • Convenient Single Cable Hookup

A rear panel connector provides for the convenience of using a single cable, (DB25 computer style) to receive all audio and power control signals from a McIntosh Multizone Control System.

#### • Individual Channel or Bridged Pair Configuration

Each pair of MC7108 amplifier channels can be operated separately at 40 watts each, or bridged for 100 watts. The MC7108 is ideal for any application requiring a multi-channel power amplifier, such as a multizone system or home theater system.

#### • Front Panel

The classic McIntosh Illuminated glass front panel includes eight individual channel power guard indicators, four channel pair status indicators and a power on off switch.

## Installation

The MC7108 can be placed upright on a table or shelf, standing on its four feet. It also can be custom installed in a piece of furniture or cabinet of your choice. The required panel cutout, ventilation cutout and unit dimensions are shown.

Always provide adequate ventilation for your MC7108. Cool operation ensures the longest possible operating life for any electronic instrument. Do not install the MC7108 directly above a heat generating component such as a high powered amplifier. If all the components are installed in a single cabinet, a quiet running ventilation fan can be a definite asset in maintaining all the system components at the coolest possible operating temperature.

A custom cabinet installation should provide the following minimum spacing dimensions for cool operation. Allow at least 2 inches (5.1 cm) above the top and 1 inch (2.54 cm) on each side of the amplifier, so that airflow is not obstructed. Allow 21 inches (53.3 cm) depth behind the mounting panel, which includes clearance for connectors. Allow 1-1/8 inches (2.9 cm) in front of the mounting panel for knob clearance. Be sure to cut out a ventilation hole in the mounting shelf according to the dimensions in the drawing.

**Front View of an MC7108 custom installed**

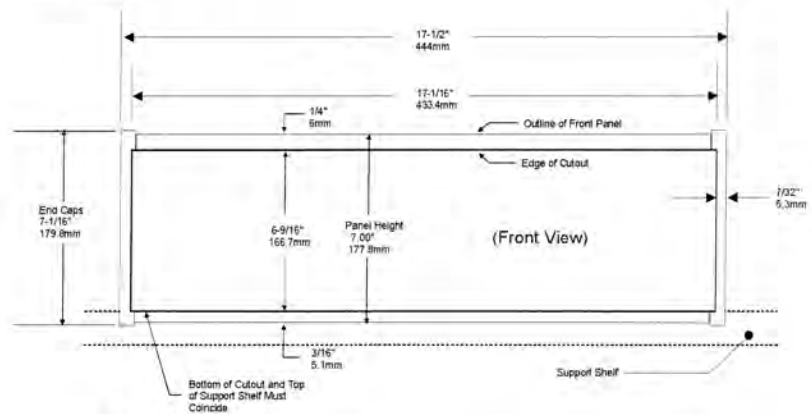

**Side View of an MC7108 custom installed**

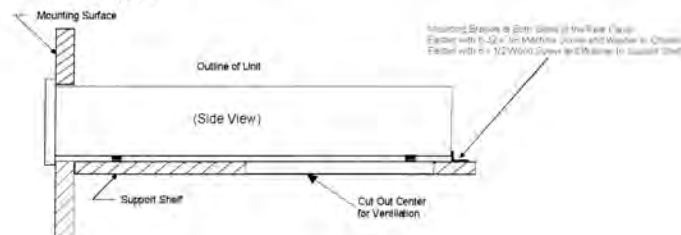

**Bottom View of an MC7108 custom installed**

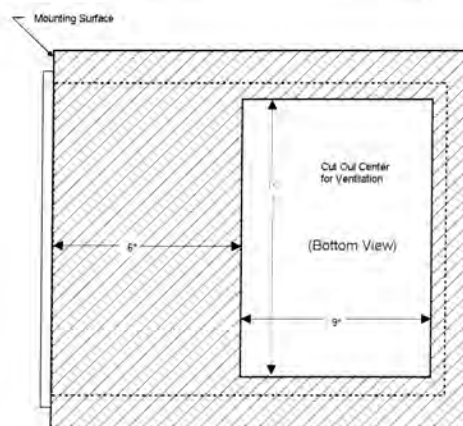





# MC7108 Rear Panel Controls and Connections

## MC7108 Rear Panel Controls and Connections

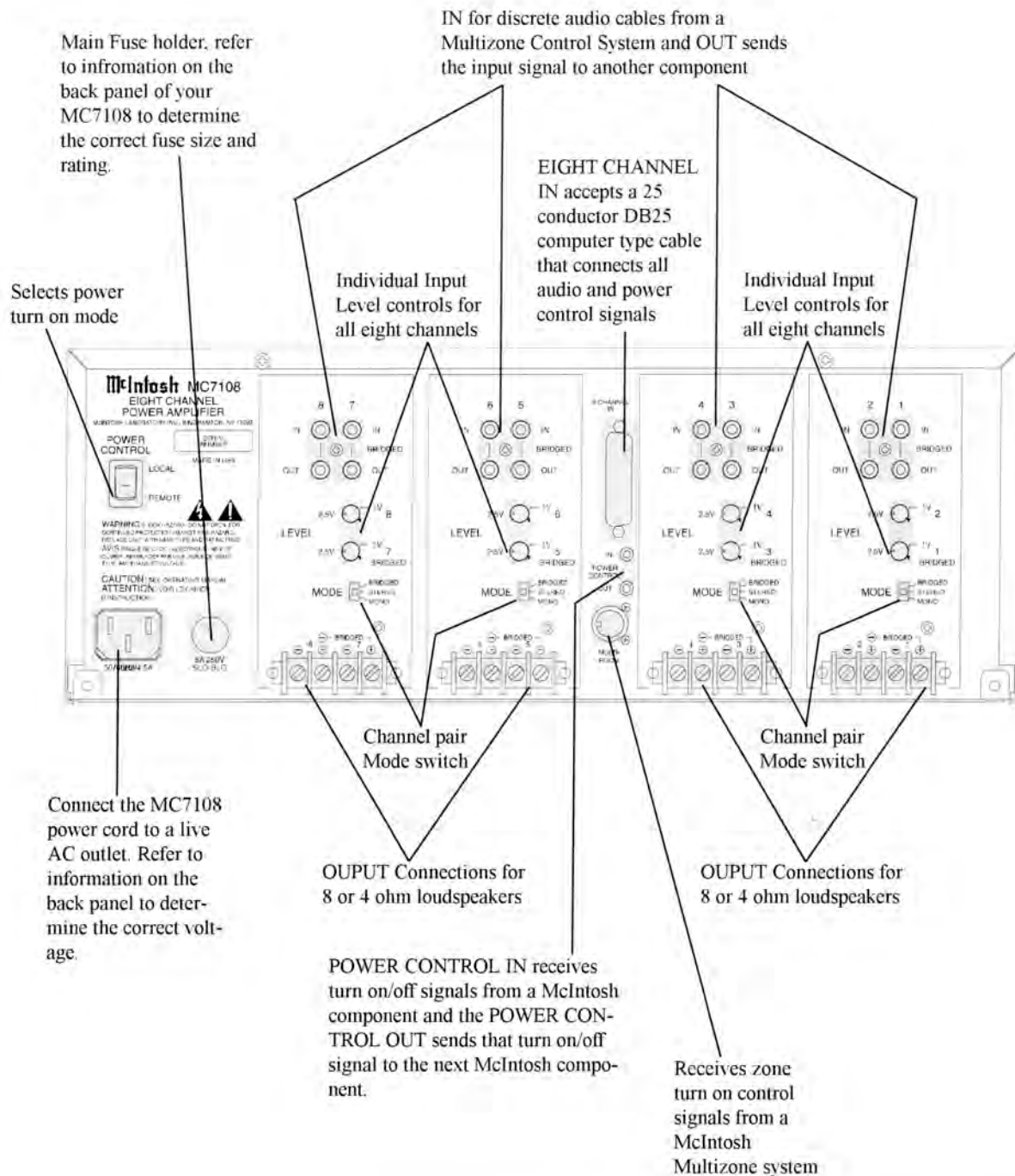

## How to Connect the MC7108 with a CR12

### How to Connect the MC7108 with a CR12

1. Connect the MC7108 power cord to a live AC outlet.
2. Connect the loudspeaker cables to the appropriate channel output connectors, being careful to observe the correct polarities.
3. Connect a single DB25 computer type cable from the Multichannel Output of a Multizone Control System to the MC7108 8 channel Input connector for all eight audio channels and power control.

*Note: Both audio and zone power control pass through this cable. Discrete zone audio cables may also be used. Also connect a cable from the CR12 Din Multi-Channel Amp connector to the matching connector on the amplifier to provide zone power control.*

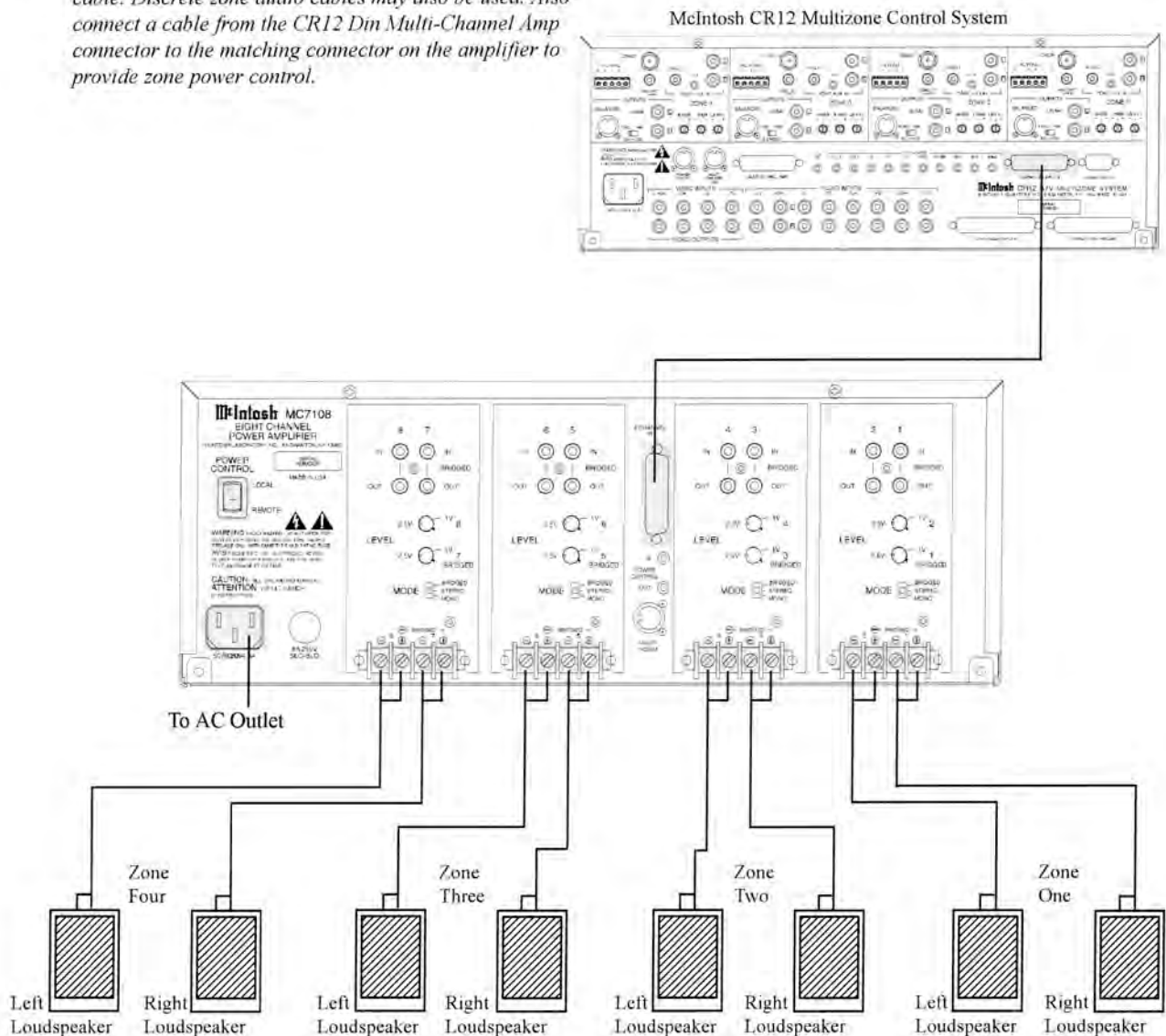



## MC7108 Front Panel Displays and Controls

### MC7108 Front Panel Displays and Controls

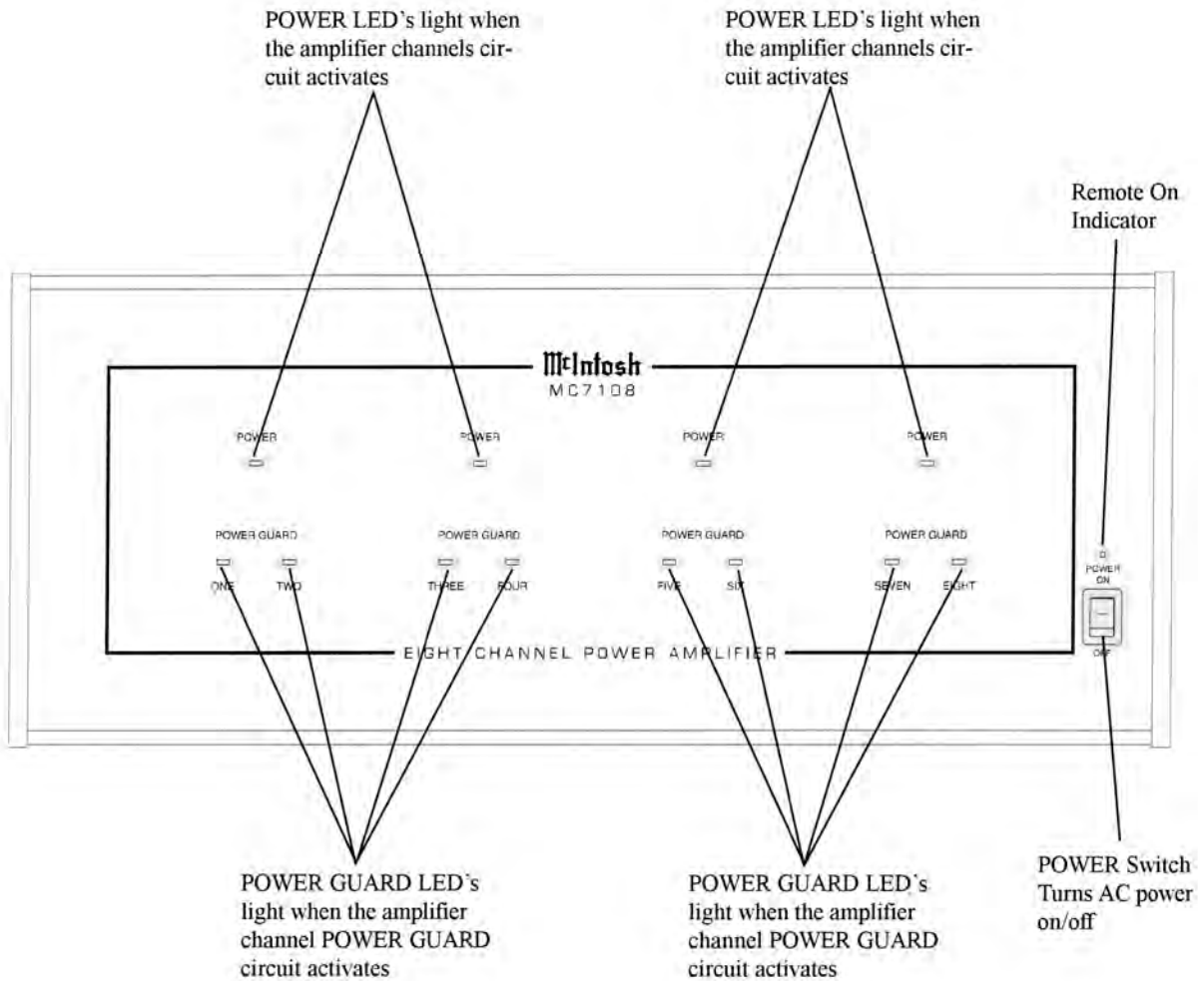



**How to Operate the MC7108**

**Input Level Controls**

When using a McIntosh Multizone Control System or Control Center set all five level controls to the 2.5V position. If a preamplifier or control center has a 1V output rating, set the controls to the 1V position. If an increase or decrease in amplifier sensitivity is required for other applications, set the controls as desired. Refer to Figure 1.

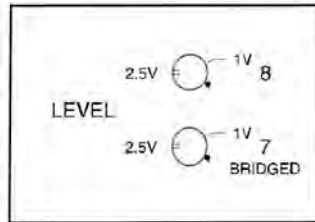

Figure 1

**Power On**

To have the MC7108 turn on or off when a multizone system turns on or off, the front panel power switch must be left in the on position and the rear panel power control switch must be in the remote position.

For non remote operation, set the rear panel power control switch to local and use the front panel power switch to turn the MC7108 on or off as desired.

*Note: There must be a power control connection between the MC7108 and the McIntosh Multizone Control System or Control Center in order for the remote power turn on to function.*

**Mode Switch**

The Mode switch allows a pair of MC7108 channels to be used in three different operating configurations.

**Stereo:** Each channel of a stereo pair operates independently as left and right stereo 40 watt amplifiers.

**Bridged:** A channel pair operates in bridged configuration for a single monaural 100 watt amplifier.

**Mono:** Channel pair inputs are connected in parallel resulting in identical outputs for each channel.

**How to Operate the MC7108 with a Bridged Channel**

The versatile McIntosh MC7108 can be used in three different operating modes. The four channel pairs can be used in stereo mode to supply 40 watts of power to four zones of a multizone system. Any of the four stereo pairs can be set to Bridged mode to supply 100 watts of power when greater power is desired. The Mono mode allows two channels to supply identical mono audio to two separate loudspeakers. A pair of MC7108 channels in Bridged mode will produce 100 watts output into a 4 ohm loudspeaker. Refer to Figure 2.

1. Set the Mode switch to the Bridged position.
2. Adjust the Bridged Level control to the 2.5V position if using a McIntosh Multizone System or Control Center.
3. Connect the cable from the signal source component to the Bridged In jack.
4. Connect loudspeaker cables to the terminals marked (-) and (+) Bridged.

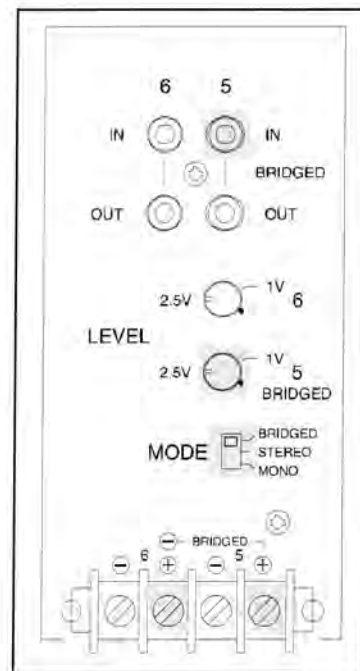

Figure 2



### Specifications

#### Power Output Per Channel

40 watts into 4 ohm loads minimum sine wave continuous average power output per channel, all channels operating.

#### Output Load Impedance

4 ohms

#### Rated Power Band

20Hz to 20,000Hz

#### Dynamic Headroom

1.8dB

#### Frequency Response

+0, -0.25dB from 20Hz to 20,000Hz

+0, -3.0dB from 10Hz to 100,000Hz

#### Total Harmonic Distortion

0.005% maximum at any power level from 250 milliwatts to rated power per channel from 20Hz to 20,000Hz, all channels operating.

#### Intermodulation Distortion

0.005% maximum if instantaneous peak output per channel does not exceed twice the rated output with all channels operating for any combination of frequencies from 20Hz to 20,000Hz.

#### Signal To Noise Ratio

92dB below rated output (Weighted)

#### Sensitivity

1 volt (2.5V at level control center detent position)

#### Input Impedance

20,000 ohms

#### Damping Factor (Wide Band)

100 @ 4 ohms

#### Power Requirements

100 Volts, 50/60Hz at 5.4 amps

110 Volts, 50/60Hz at 4.9 amps

120 Volts, 50/60Hz at 4.5 amps

220 Volts, 50/60Hz at 3.1 amps

230 Volts, 50/60Hz at 3.1 amps

240 Volts, 50/60Hz at 3.1 amps

*NOTE: Refer to the rear panel of the MC7108 for the correct voltage*

#### Dimensions

Front Panel: 17 1/2 inches (44.5cm) wide, 7-1/16 inches (17.9cm) high. Depth behind front mounting panel is 20 inches (50.8cm) including clearance for connectors. Panel clearance required in front of mounting panel is 3/4 inches (1.9cm).

#### Weight

40 pounds (18.1Kg) net, 58 pounds (28.3Kg) in shipping carton

## Packing Instructions

### Packing Instructions

In the event it is necessary to repack the equipment for shipment, the equipment must be packed exactly as shown below. It is very important that the four plastic feet are attached to the bottom of the equipment. Three #10 x 2-1/4" screws and washers must be used to fasten the unit securely to the bottom pad and wood skid. This will ensure the proper equipment location on the bottom pad. Failure to do this will result in shipping damage.

Use the original shipping carton and interior parts only if they are all in good serviceable condition. If a shipping carton or any of the interior part(s) are needed, please call or write Customer Service Department of McIntosh Laboratory. Please see the Part List for the correct part numbers.

Quantity	Part Number	Description
1	033888	Shipping carton only
4	033887	End cap (Foam pad)
1	033697	Inside carton only
1	033725	Top Pad
1	034008	Bottom pad
3	017218	Plastic foot (spacer)
1	033699	Wood skid
3	101169	#10 x 2-1/4" Wood screw
3	104033	#10 x 1-3/4" Wood screw
4	017218	Plastic foot
4	100159	#10-32 x 3/4" Machine screw
4	104083	#10 x 7/16" Flat washer
1	040572	Shipping carton complete with all the above parts

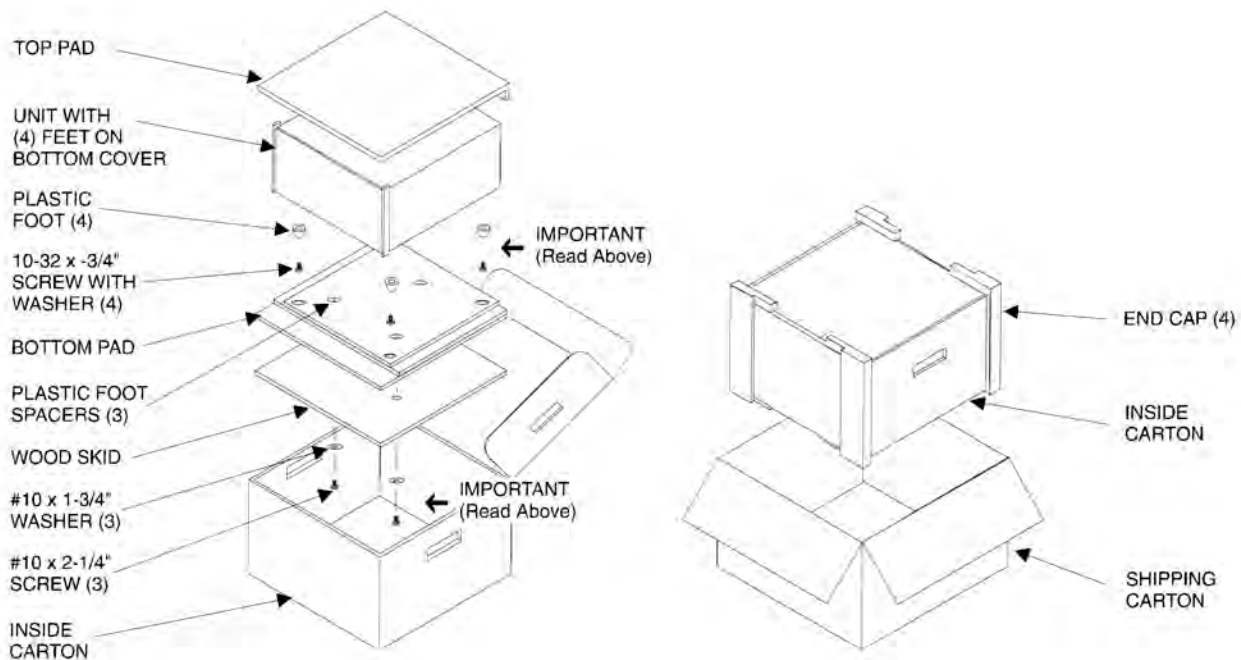

# McIntosh<sup>®</sup>

McIntosh Laboratory, Inc.  
2 Chambers Street  
Binghamton, NY 13903

McIntosh Part No. 040567