



AM/FM Tuner



MR85 Owner's Manual



The lightning flash with arrowhead, within an equilateral triangle, is intended to alert the user to the presence of uninsulated "dangerous voltage" within the product's enclosure that may be of sufficient magnitude to constitute a risk of electric shock to persons.



AVIS RISQUE DE CHOC ELECTRIQUE - NE PAS OUVRIR.

The exclamation point within an equilateral triangle is intended to alert the user to the presence of important operating and maintenance (servicing) instructions in the literature accompanying the appliance.

WARNING - TO REDUCE RISK OF FIRE OR ELECTRICAL SHOCK, DO NOT EXPOSE THIS EQUIPMENT TO RAIN OR MOISTURE.

NO USER-SERVICEABLE PARTS INSIDE. REFER SERVICING TO QUALIFIED PERSONNEL.

To prevent the risk of electric shock, do not remove cover or back. No user-serviceable parts inside.

IMPORTANT SAFETY INSTRUCTIONS!

PLEASE READ THEM BEFORE OPERATING THIS EQUIPMENT.

1. Read these instructions.
2. Keep these instructions.
3. Heed all warnings.
4. Follow all instructions.
5. Do not use this apparatus near water.
6. Clean only with a dry cloth.
7. Do not block any ventilation openings. Install in accordance with the manufacturer's instructions.
8. Do not install near any heat sources such as radiators, heat registers, stoves, or other apparatus (including amplifiers) that produce heat.
9. Do not defeat the safety purpose of the polarized or grounding-type plug. A polarized plug has two blades with one wider than the other. A grounding type plug has two blades and a third grounding prong. The wide blade or the third prong are provided for your safety. If the provided plug does not fit into your outlet, consult an electrician for replacement of the obsolete outlet.
10. Protect the power cord from being walked on or pinched particularly at plugs, convenience receptacles, and the point where they exit from the apparatus.
11. Only use attachments/accessories specified by the manufacturer.
12. Use only with the cart, stand, tripod, bracket, or table specified by the manufacturer, or sold with the apparatus. When a cart is used, use caution when moving the cart/apparatus combination to avoid injury from tip-over. 
13. Unplug this apparatus during lightning storms or when unused for long periods of time.
14. Refer all servicing to qualified service personnel. Servicing is required when the apparatus has been damaged in any way, such as power-supply cord or plug is damaged, liquid has been spilled or objects have fallen into the apparatus, the apparatus has been exposed to rain or moisture, does not operate normally, or has been dropped.
15. Do not expose this equipment to dripping or splashing and ensure that no objects filled with liquids, such as vases, are placed on the equipment.
16. To completely disconnect this equipment from the a.c. mains, disconnect the power supply cord plug from the a.c. receptacle.
17. The mains plug of the power supply cord shall remain readily operable.

Outdoor Antenna Grounding

If an outside antenna or cable system is connected to the product, be sure the antenna or cable system is grounded so as to provide some protection against voltage surges and built-up static charge. Article 810 of the National Electrical Code, ANSI/NFPA 70, provides information with regards to proper grounding of the mast and supporting structure, grounding of the lead-in wire to an antenna discharge unit, and size of ground conductors, location of antenna-discharge unit, connection to ground electrodes and requirements for the grounding electrode.

Example of antenna grounding as per National Electrical Code, ANSI/NFPA 70

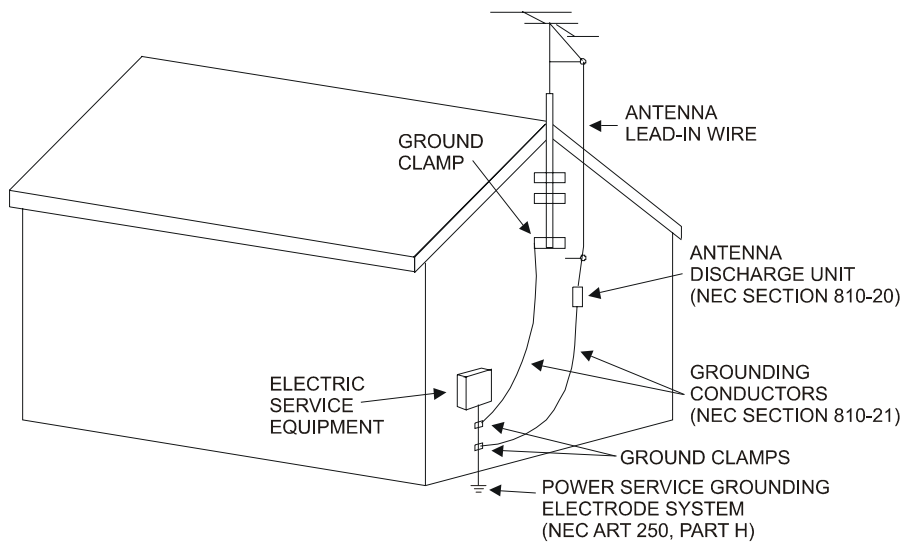



Thank You

Your decision to own this McIntosh MR85 AM/FM Tuner ranks you at the very top among discriminating music listeners. You now have "The Best." The McIntosh dedication to "Quality," is assurance that you will receive many years of musical enjoyment from this unit.

Please take a short time to read the information in this manual. We want you to be as familiar as possible with all the features and functions of your new McIntosh.

Please Take A Moment

The serial number, purchase date and McIntosh Dealer name are important to you for possible insurance claim or future service. The spaces below have been provided for you to record that information:

Serial Number: _____

Purchase Date: _____

Dealer Name: _____

Technical Assistance

If at any time you have questions about your McIntosh product, contact your McIntosh Dealer who is familiar with your McIntosh equipment and any other brands that may be part of your system. If you or your Dealer wish additional help concerning a suspected problem, you can receive technical assistance for all McIntosh products at:

McIntosh Laboratory, Inc.
2 Chambers Street
Binghamton, New York 13903
Phone: 607-723-1545
Fax: 607-723-3636

Customer Service

If it is determined that your McIntosh product is in need of repair, you can return it to your Dealer. You can also return it to the McIntosh Laboratory Service Department. For assistance on factory repair return procedure, contact the McIntosh Service Department at:

McIntosh Laboratory, Inc.
2 Chambers Street
Binghamton, New York 13903
Phone: 607-723-3515
Fax: 607-723-1917

Copyright 2001, 2004 © by McIntosh Laboratory, Inc.

Table of Contents

Safety Instructions	2
Thank You and Please Take a Moment	2
Technical Assistance and Customer Service	2
Table of Contents and Important Information	2
Connector Information	5
Introduction and Performance Features	5
Dimensions	6
Installation	7
MR85 Rear Panel and RAA1 Top Panel Connections	8
How to Connect	9
How to Connect with Optional Tuner Module	10
Front Panel Controls, Displays, Push-Buttons and Switch	11
How to Operate	12
How to Assign Preset Stations and Custom Names	14
Preset Station Lists	16
Information about the Optional TM1 Tuner Module	17
Specifications	18
Packing Instruction	19

Important Information

1. The following Connecting Cable is available from the McIntosh Parts Department:

Data and Power Control Cable Part No. 170-202

Six foot, 2 conductor shielded, with two 1/8 inch stereo mini phone plugs.

RAA1 AM Antenna Connecting Cable Part No. 171-371

Thirty foot, 2 conductor shielded, with 7 pin DIN Plug and 5 pin Terminal Plug.

- For additional connection information, refer to the owner's manual(s) for any component(s) connected to the MR85.
- The MR85 Tuner has the provision for adding an optional second TM1 Tuner Module and is available from your McIntosh Dealer. With the addition of this second tuner module, you can be listening to two different radio stations simultaneously. This allows for such capabilities as listening to one station while recording a different station or listening to one station, while another station is being listened to in a second room.
- Several different types of FM antennas or cable reception can be used with the MR85.
 - A flexible indoor dipole antenna makes a convenient antenna for high signal strength areas and may be effective in buildings without metal siding or insulation.
 - An existing outdoor directional VHF-TV/FM or FM Antenna with a rotor can be connected and will provide the best reception. Consult your McIntosh Dealer for assistance.
 - A signal from your local cable company can also be connected. Consult your cable company for installation assistance.
- FM Antenna connections to the MR85 require either RG6 or RG59U coaxial cable.

Connector Information

RAA1 Connector

Connect the shield and two leads of a shielded 2 conductor cable to the supplied 5 Pin Terminal Connector Plug. Refer to the connection information on the top cover of the RAA1.

5 Pin Terminal Connector

- 1. N/C
- 2. N/C
- 3. Red Wire
- 4. Black Wire
- 5. Green Wire (Shield)

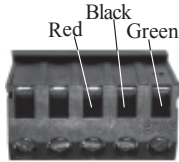

7 Pin DIN Connector

- 1. Red Wire
- 2. Black Wire
- 3. N/C
- 4. N/C
- 5. N/C
- 6. Jumper from Pin 7
- 7. Green Wire (Shield) and Jumper to Pin 6

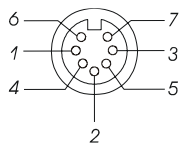

Power Control Connectors

The MR85's Power Control Output provides a 5 volt signal. Use a 1/8 inch stereo mini phone plug to connect to the Power Control Output on other McIntosh Components.

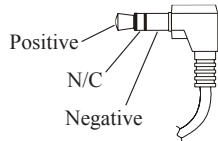

Data Connectors

The MR85's Data Port Output provides Remote Control Signals. Use a 1/8 inch stereo mini phone plug to connect to the Data Port Inputs on McIntosh A/V Control Centers.

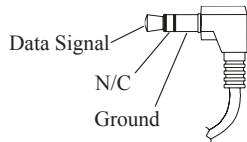

Introduction

The MR85 AM/FM Tuner is an elegant instrument that allows you to enjoy outstanding music reproduction. It includes a wide range of convenient operating functions to enhance your listening experience. The classic McIntosh MR85 will perfectly compliment a McIntosh System of incomparable performance and style.

Performance Features

● **Special FM RF Amplifier**

Double-Diffused Metal Oxide Field Effect Transistor (DMOS-FET) RF amplifier increases sensitivity and Cross Modulation rejection.

● **External AM RF Amplifier and Antenna**

The included RAA1 Remote AM Antenna contains an electrostatically shielded AM RF Amplifier Stage and can be located in a remote area away from sources of interference

assuring the best possible reception.

● **Flywheel Manual Tuning and Automute**

A newly designed, optically encoded weighted flywheel system makes 'dialing in' stations a breeze. Reminiscent of the dial-cord flywheel tuning method found in classic McIntosh Tuners. The MR85 automatically mutes when manually tuning between stations, yet provides the ability to be switched off when searching for very weak stations.

● **FM Stereo Auto Blend Circuitry and Spatial Sound Enhancement**

An automatic variable stereo separation control circuit is used to reduce background noise when receiving weak stereo stations. A sound Spatializer circuit can be selected for Tuner 1 Enhancement. This circuit can expand the sound field for FM stations with poor separation; it also provides a pseudo-stereo effect for AM stations.

● **Optional Second Tuner Module**

The McIntosh TM1 Tuner Module may be added to the MR85 by your Dealer and is the most economical way to add a second tuner to a system. This is ideal for applications where two tuners may be used at the same time, such as Multizone Systems or listening to one station while recording another station.

● **Preset Stations and Custom Preset Naming**

Nine AM and nine FM station presets with custom naming (any desired name may contain up to eight characters) for each tuner module make it easy to listen to your favorite stations. For example, FM Preset Number 3 (92.50MHz) can be renamed "JAZZ 7", or "WXYZ". The station presets, custom naming and functions modes are retained in Permanent Memory even when AC power is turned off.

● **Alphanumeric Fluorescent Display**

The Multifunction Front Panel Display indicates station frequency, station preset number, custom naming, signal strength, stereo and broadcast band. The display intensity is fully adjustable.

● **Adjustable Output Level and Remote Control Capable**

Both Tuner 1 and the optional Tuner 2 have Variable Outputs which can be used to match audio levels between various sources. When used in conjunction with a McIntosh Control Center or Multizone Controller, tuning functions can be performed with a remote control.



MR85 Dimensions

The following dimensions can assist in determining the best location for your MR85. There is additional information on the next page pertaining to installing the MR85 into cabinets.

Front View of the MR85



Rear View of the MR85



Side View of the MR85

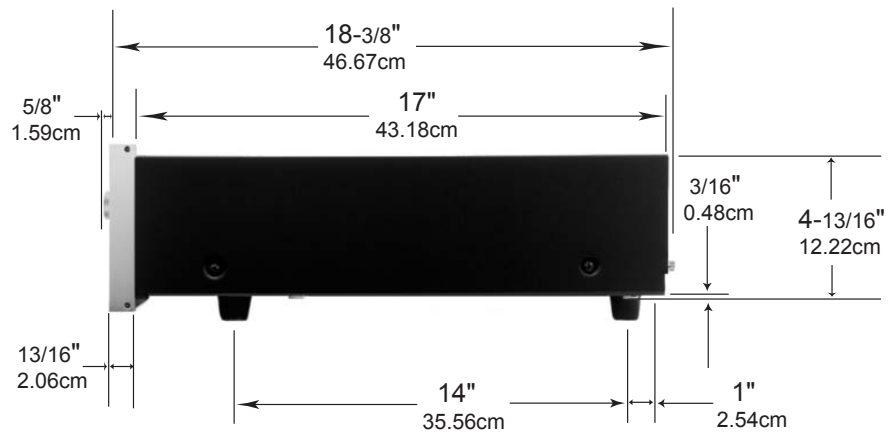

Installation

The MR85 can be placed upright on a table or shelf, standing on its four feet. It also can be custom installed in a piece of furniture or cabinet of your choice. The four feet may be removed from the bottom of the MR85 when it is custom installed as outlined below. The four feet together with the mounting screws should be retained for possible future use if the MR85 is removed from the custom installation and used free standing. The required panel cutout, ventilation cutout and unit dimensions are shown.

1 inch (2.54 cm) on each side of the AM/FM Tuner, so that airflow is not obstructed. Allow 20 inches (50.8 cm) depth behind the front panel. Allow 1 inch (2.54 cm) in front of the mounting panel for knob clearance. Be sure to cut out a ventilation hole in the mounting shelf according to the dimensions in the drawing.

Always provide adequate ventilation for your MR85.

Cool operation ensures the longest possible operating life for any electronic instrument. Do not install the MR85 directly above a heat generating component such as a high powered amplifier. If all the components are installed in a single cabinet, a quiet running ventilation fan can be a definite asset in maintaining all the system components at the coolest possible operating temperature.

A custom cabinet installation should provide the following minimum spacing dimensions for cool operation. Allow at least 2 inches (5.08 cm) above the top, 2 inches (5.08cm) below the bottom and

MR85 Front Panel Custom Cabinet Cutout



MR85 Side View in Custom Cabinet

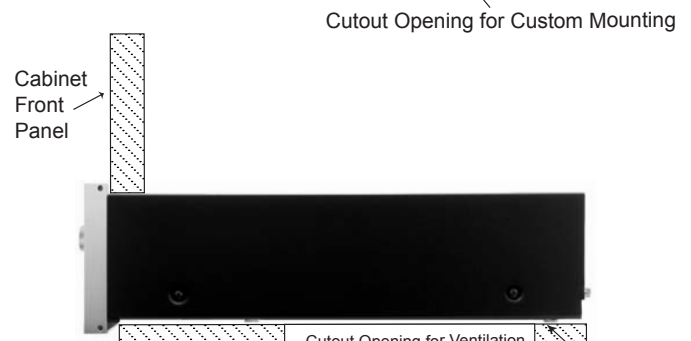

MR85 Bottom View in Custom Cabinet

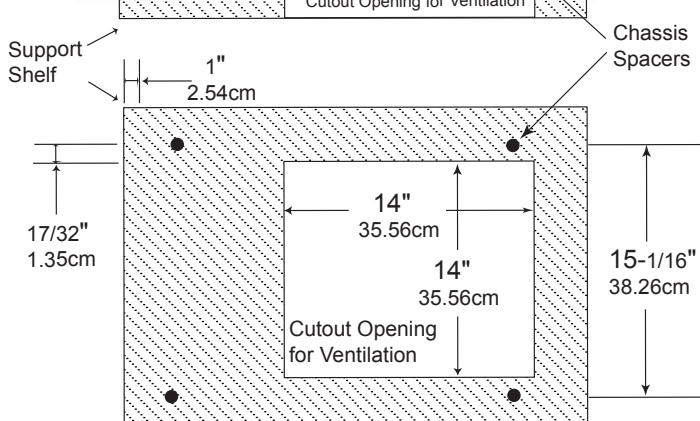



MR85 Rear Panel and RAA1 Top Panel Connections

ANTENNA 1
RAA1 AM ANT
connector for the
supplied McIntosh
Remote AM Antenna

POWER CONTROL IN
jack accepts a turn on signal from a McIntosh Control Center. The OUT jack sends the turn on signal to another McIntosh product

TUNER 2 OUTPUT
LEVEL control reserved for the optional TM1 second tuner module

TUNER 1 VARIABLE
OUTPUTS supply audio signals that can be adjusted by the rear panel TUNER 1 OUTPUT LEVEL control

TUNER 1 DATA IN
jack receives tuner control and operating data from a McIntosh Control Center to control the Tuner 1 Module

Spaces reserved for the optional TM1 second tuner module

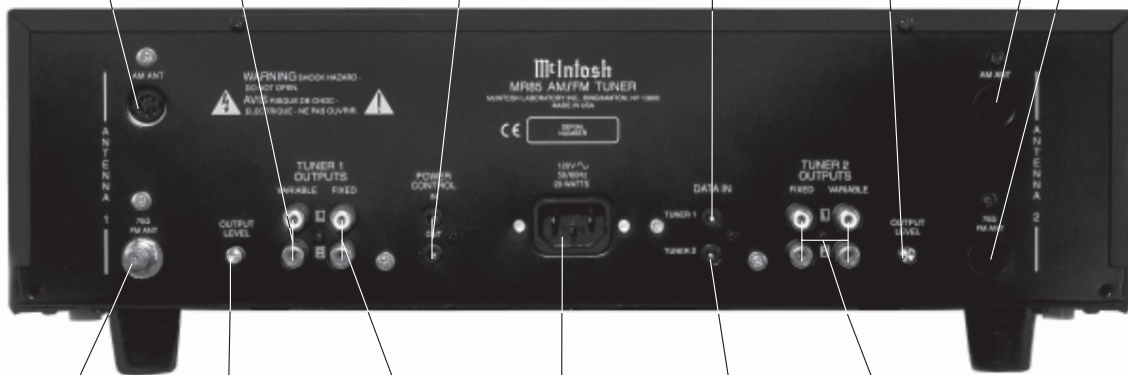

ANTENNA 1
75Ω (ohm) FM
ANT connects to an external FM antenna or cable

TUNER 1 FIXED
OUTPUTS supply audio signals at a volume level that cannot be changed

TUNER 2 DATA
IN jack reserved for the optional TM1 second tuner module

TUNER 1 OUTPUT
LEVEL control adjusts the volume level of the Variable Outputs

Connect the MR85 power cord to a live AC outlet. Refer to information on the back panel of the MR85 to determine the correct voltage

TUNER 2 FIXED and VARIABLE OUTPUTS jacks reserved for the optional TM1 second tuner module

EXT TUNER connects to the MR85 Tuner RAA1 ANTenna 1 Input



How to Connect

1. Connect a data cable from the TUNER 1 DATA IN jack to the TUNER DATA PORT of a McIntosh Control Center or Preamplifier.

Note: Remote Control operation of the Tuner is made possible with a Data Cable connected between the MR85 and a McIntosh Control Center or Preamplifier. If the MR85 Tuner is connected to a non-McIntosh Preamplifier, remote control operation is still possible with an appropriate interface and McIntosh Remote Control. Contact your McIntosh Dealer for additional details.

2. Connect a power control cable from the POWER CONTROL IN jack to the POWER CONTROL OUT or ACC jack of a McIntosh Preamplifier, Control Center or other McIntosh component.

3. Connect an audio cable from the TUNER 1 FIXED OUTPUTS to the TUNER INPUTS of a preamplifier or control center.

Note: An optional connection would be to use the TUNER 1 VARIABLE OUTPUTS.

4. Connect the FM Antenna or Cable (from the Cable Company) to the MR85 Tuner 75Ω (Ohm) FM ANTenna connector.
5. Connect with the supplied cable, from the 5 Pin Socket of the McIntosh RAA1 Remote AM Antenna to the MR85 Tuner RAA1 AM ANTenna DIN Socket.
6. Plug the MR85 AC Power Cord into an AC Outlet.

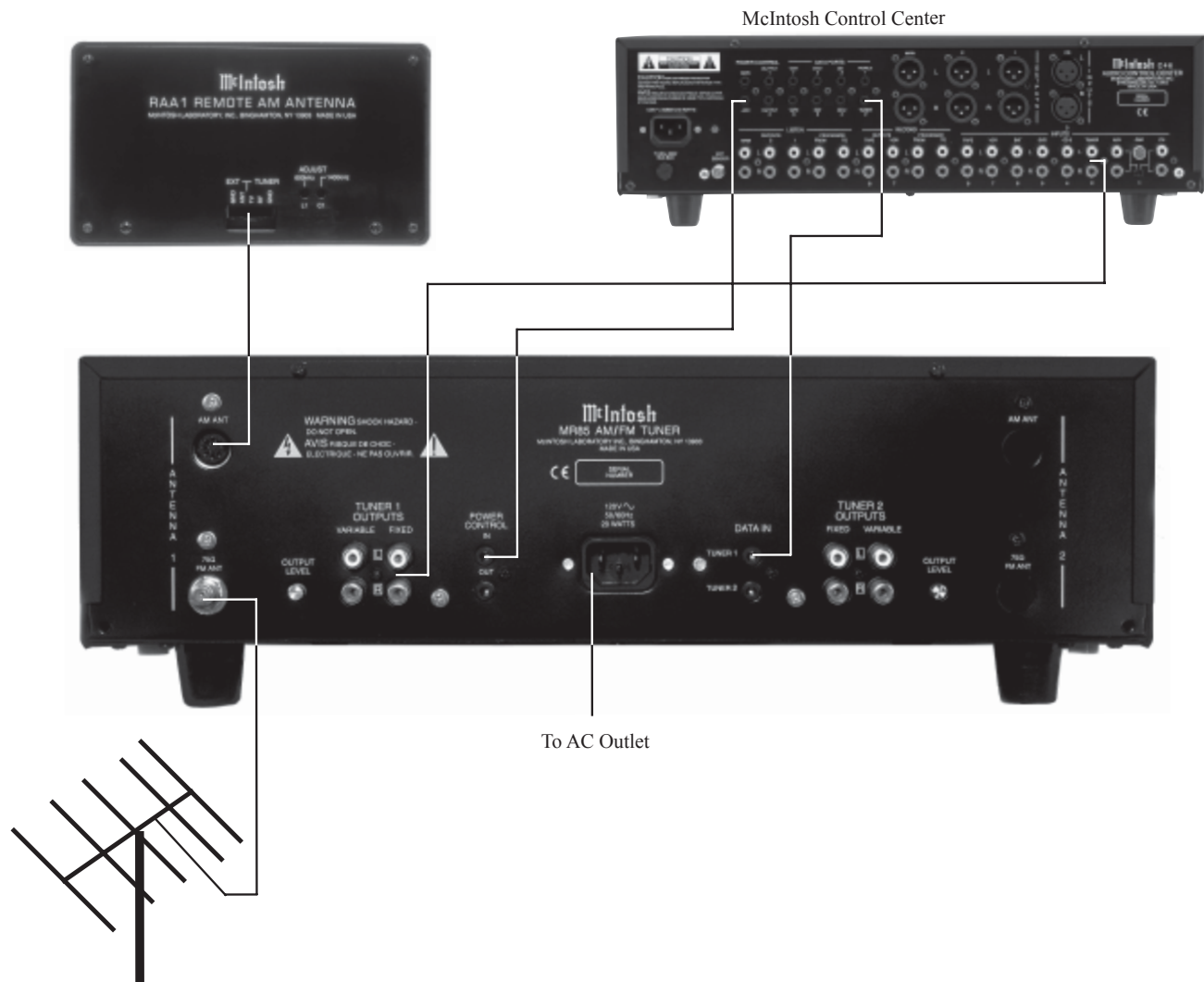



How to Connect with Optional Tuner Module

How to Connect with Optional Tuner Module

1. Connect a data cable from the TUNER 1 DATA IN jack to the TUNER DATA PORT of a McIntosh Multizone Control Center.

Note: Remote Control operation of the Tuner is made possible with a Data Cables connected between the MR85 and a McIntosh Control Center or Preamplifier. If the MR85 Tuner is connected to a non-McIntosh Preamplifier, remote control operation is still possible with an appropriate interface and McIntosh Remote Control. Contact your McIntosh Dealer for additional details.

2. Connect a data cable from the TUNER 2 DATA IN jack to the LOCAL ZONE 1 AUX IN DATA PORT of a McIntosh Multizone Controller.
3. Connect a power control cable from the POWER CONTROL IN jack to the POWER CONTROL OUT of a McIntosh Multizone Controller.

4. Connect an audio cable from the TUNER 1 FIXED OUTPUTS to the TUNER INPUTS of a McIntosh Multizone Controller.

Note: An optional connection would be to use the TUNER 1 VARIABLE OUTPUTS.

5. Connect an audio cable from the TUNER 2 FIXED OUTPUTS to the LOCAL ZONE 1

AUX IN AUDIO Jacks of a McIntosh Multizone Controller.

Note: An optional connection would be to use the TUNER 2 VARIABLE OUTPUTS.

6. Connect the FM Antenna(s) or Cable (from the Cable Company) to the MR85 Tuner 75Ω (Ohm) FM ANTenna connector for both Tuner 1 and 2.

Note: If the same FM Antenna or Cable (from the Cable Company) is used for both Tuner 1 and 2, a suitable coaxial splitter must be utilized.

7. Connect with the supplied cables, from the 5 Pin Socket of the McIntosh RAA1 Remote AM Antenna to the MR85 Tuner RAA1 AM ANTenna DIN Sockets for both Tuner 1 and 2.

8. Plug the MR85 AC Power Cord into an AC Outlet.

McIntosh Multizone Controller

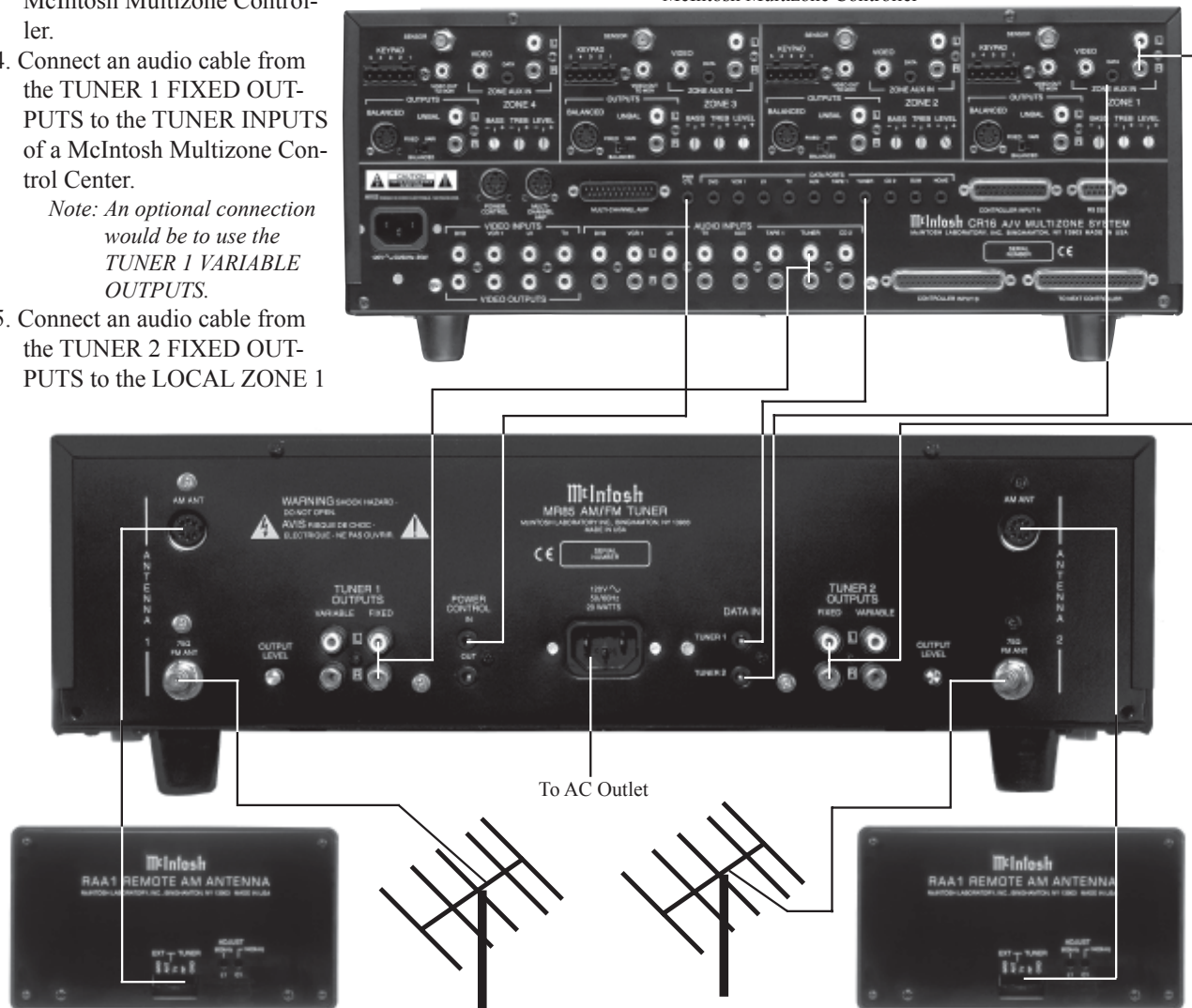

Front Panel Controls, Displays, Push-Buttons and Switch

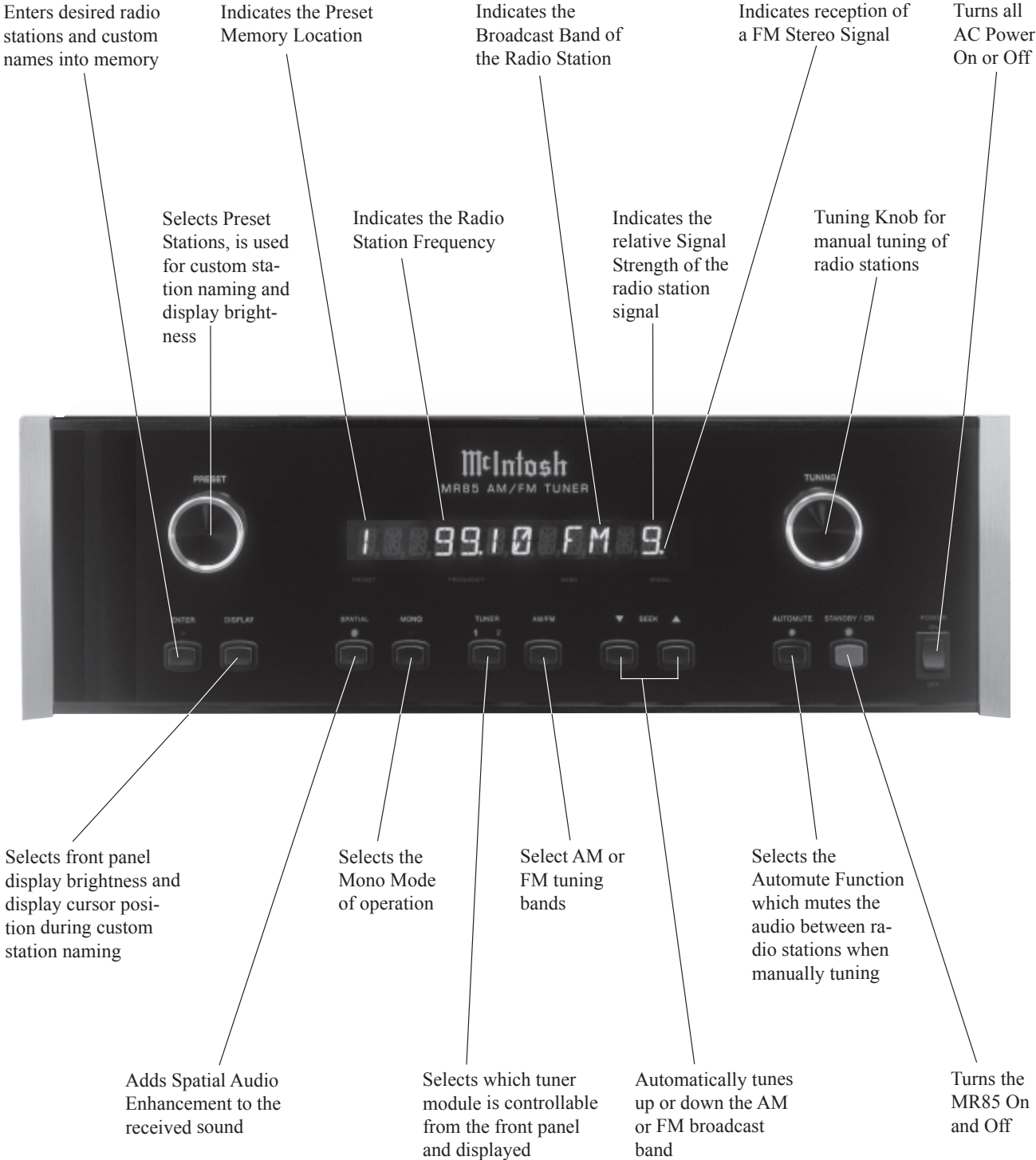



How to Operate

Power On

Press the POWER switch to ON. The Red LED, above the STANDBY/ON Push-button, lights to indicate the MR85 is in Standby Mode. To turn ON the MR85 press the STANDBY/ON push-button. Refer to figure 1.

Note: The POWER Switch is only intended to be switched OFF when the MR85 Tuner is not used for extended periods of time, like while away on vacation. During normal operation, the POWER Switch should stay in the ON position. Press the STANDBY/ON Push-button for turning the MR85 ON and OFF. When the Power Control Cable is connected to a McIntosh Control Center, A/V Multizone System Controller or Preamplifier, the MR85 Tuner will automatically switch ON and OFF.

The McIntosh MR85 is an advanced design AM/FM Tuner with many desirable performance features to enhance your enjoyment of radio broadcasts. There are three modes of tuning to an AM/FM Broadcast Station. There is Manual Tuning using the TUNING Knob; Seek Mode Station Selection using the SEEK ▲ (Up) and ▼ (Down) Push-button(s); and Preset Station Selection using the PRESET Selection Knob.

Note: When the MR85 AM/FM Tuner is connected to a McIntosh Control Center, A/V Multizone System Controller or Preamplifier via a data connection, the tuner functions such as SEEK, direct PRESET Selection and REVIEW of Preset Stations may be controlled by the McIntosh Remote Control and/or Keypad.

Preset Selector Switch

The PRESET Selection Switch allows selection of desired radio stations that have already been stored into memory. There are up to 9 AM and 9 FM stations that can be stored for the Tuner 1. The optional secondary Tuner 2 Module also has up to 9 AM and 9 FM stations that can be stored

into memory. The PRESET Selection Switch also assists in changing the Front Panel Alphanumeric Display from indicating the Station Frequency (default), to displaying personalized names of your choice. Example, instead of the Front Panel Display showing Preset number 3 as “105.70 FM” it could display “JAZZ 7”. Refer to “How to Assign Presets Stations and Custom Names” for further information.

Note: The PRESET Selection Switch will not access Station Presets that have been left blank. If no Presets have been assigned, the Front Panel Display will show “NO PRESETS” until at least one station has been entered into memory. Refer to figure 2 below.



Figure 2

Manual Tuning

Manual Tuning is provided through the Front Panel TUNING Knob. Rotate the TUNING Knob clockwise to tune up in frequency, 10kHz steps for AM or 200kHz steps for FM. Spin the knob to tune up continuously. Rotate the TUNING Knob counterclockwise in the same manner to tune down in frequency. When a station is selected, the Front Panel Display will indicate (from left to right) a Preset Number, if that station has been assigned a Preset, the FM Station Frequency, the received Stations Signal Strength from 1 to 9, and a dot (located to the right of the Signal Strength Digit) if the station is broadcasting stereo.

Note: FM band indications are in Megahertz. In the US and Canada, they change frequency in 200kHz steps. The second digit to the right of the dot which displays a 0, is used for FM stations in Europe where stations change in 50kHz steps. In Europe and Japan, the AM display changes in 9kHz steps.



Figure 1

Enter Mode

The ENTER Push-button is used to enter into memory, desired AM or FM radio stations and any custom naming you might wish. A station Preset and its custom name may also be cleared from memory using the ENTER Push-button. The LED above the ENTER Push-button will light when in the Preset Enter Mode.

Display Modes

Press the DISPLAY Push-button and rotate the PRESET Knob to adjust the Front Panel Alphanumeric Display Brightness from 0 (Off) to 31 (Bright), refer to figure 3.



Figure 3

Note: For Custom Naming Station Presets with the name of your choice refer to page 15.

Spatial Enhancement

Press the SPATIAL push-button to add Audio Enhancement to either an AM or FM signal. For example, AM Stations with monaural signals will have a simulated stereo effect. The LED above the SPATIAL Push-button will light when in the Spatial Mode.

Note: The Spatial Enhancement function is for the Tuner 1 only.

Mono Mode

Press the MONO Push-button to combine left and right stereo signals to monaural. This is useful when the MR85 Tuner is receiving a very weak Stereo Signal that might be accompanied with a high degree of background noise. By switching to MONO Mode, most of the background noise will disappear, thus making the station more listenable. The LED above the MONO Push-button will light when in the MONO Mode.

Note: When the tuned to an AM Radio Station the tuner will automatically switch to the MONO Mode.

Tuner Selector

The Tuner Selector selects between the default Tuner 1 and the optional secondary Tuner 2 Module, if installed. Once the desired tuner is selected, the Front Panel Controls including Station Selection and Preset Assignment may be performed. The Number 1 LED above the TUNER Push-button will light, indicating when Tuner 1 has been selected and the Number 2 LED above the TUNER Push-button will light when Tuner 2 Module is selected.

Note: If the optional secondary Tuner 2 Module is not installed, the TUNER Selector will stay on the TUNER 1 selection.

AM/FM Band Selector

Select the AM or FM Broadcast Band by pressing the AM/FM push-button.

Note: When the Front Panel Alphanumeric Display is displaying the radio station frequency (default), the letters AM or FM will appear to the right of the tuned stations frequency to indicate the broadcast band.

SEEK ▲ and ▼

Press and release the Front Panel SEEK ▲ (Up) and ▼ (Down) Push-button(s), to move from one station to the next. Press and hold the SEEK Push-button to move continuously up or down the broadcast band.

Automute Function

When manually tuning through the band, the outputs will unmute only when a strong radio station is sensed and received. Sometimes it is desirable to search for a very weak station and the AUTOMUTE Function can be switched OFF. This will allow all stations to be heard as well as noise and interference normally found in-between stations. The LED above the AUTOMUTE Push-button will light when the Automute Function is active.

Note: The AUTOMUTE Function can only be switched OFF when manually tuning to a station using the TUNING Knob. When using SEEK ▲ (Up) and ▼ (Down) Push-button(s), the AUTOMUTE Function will always be engaged.

Output Level Control (Rear Panel)

There are both FIXED OUTPUTS and VARIABLE OUTPUTS on the MR85 Rear Panel for Tuner 1 and optional secondary Tuner 2 Module. For most applications, the volume level at the FIXED OUTPUTS will match other sources connected to the McIntosh Control Center or Preamplifier. If the volume level from the tuner is higher than from other sources, the VARIABLE OUTPUTS together with the OUTPUT LEVEL Control may be used to reduce the tuner volume level.

Reset of Microprocessor

In the event that the controls of the MR85 stop functioning, there is a built-in user reset function. Press the POWER switch to the OFF position and wait for two minutes. Then press the POWER switch to ON; the Red LED above the STANDBY/ON Push-button, lights to indicate the MR85 is



in Standby Mode. To turn ON the MR85, press the STANDBY/ON Push-button.

Note: The above condition is usually caused by either interruptions or changes in AC voltage.

How to Assign Preset Stations

The MR85 AM/FM Tuner allows for presetting your favorite radio stations into memory. It will also remember any desired audio modes of operation such as Stereo/Mono and Spatial Enhancement for each station separately. To enter Presets and Audio Modes follow the below steps:

Note: The MR85 Tuner 1 and the optional secondary Tuner 2 Module each can store up to 9 AM and 9 FM stations.

1. Select the AM or FM broadcast band.
2. Tune to the desired radio station with either the Front Panel TUNING Knob or the SEEK ▲ (Up) and ▼ (Down) Push-button(s).
3. Optionally, select the Mono and/or Spatial Enhancement Modes of Operation for that station.

Note: The Spatial Enhancement Mode is only applicable to the Tuner 1. All AM Radio Stations are automatically received in Mono.

4. Momentarily press and release the Front Panel ENTER push-button. The LED above the ENTER push-button will light and the Front Panel Display will indicate 1 AVAILABLE, which is the first of 9 Preset Numbers that can be assigned. Refer to figure 4.



Figure 4

Note: Presets are automatically assigned in order from 1 to 9.

5. Press and release the front panel ENTER push-button a second time to store the Preset into memory, the LED above the ENTER push-button will turn off and that station Preset Selection will be assigned Preset Number 1. The assigned Preset Number will appear on the Front Panel Display to the right of the Station Frequency whenever it is selected. Refer to figure 5.
6. Assign additional station Presets by performing steps 1 through 5 until a total of 9 AM and 9 FM Station Presets have been assigned. Each time you assign an additional Preset Number, the Front Panel Display will indicate the number of the next available preset.

Note: If all 9 presets are assigned and you press ENTER, the display will indicate the station selected for preset number 1.



Figure 5

7. To verify the Station Preset(s) you have just entered, rotate the PRESET Knob clockwise or counterclockwise to cycle through and confirm your preset assignments.

How To Clear an Assigned Station Preset

1. Press and release the ENTER Push-button; the LED above the ENTER Push-button will light.
2. Rotate the PRESET Knob clockwise or counterclockwise to select the desired Station Preset you wish to clear.
3. Press and Hold the ENTER Push-button for approximately 3 seconds until the Front Panel Display indicates the word CLEARED. Refer to figure 6.



Figure 6

Note: If you wish to replace an already assigned Station Preset with another radio station, it is not necessary to clear the Preset first, just enter in the new station for that Preset. The new station will automatically replace the previously assigned station.

4. To clear any additional Station Presets perform steps 1 through 3 again.

How to Assign Custom Names

The Front Panel Alphanumeric Display of the MR85 together with the built in memory, allows for Custom Naming of each Station Preset. Instead of the Front Panel just indicating the frequency of the received radio station, it could indicate such things as type of music played on that station. The assignable characters include the alphabet, numbers, and symbols. To enter Custom Presets Names follow the below steps:

Note: In the below example, we will Custom Name an already assigned FM Station Preset Number 1 which has a frequency of 99.10MHz and rename it JAZZ 7. The Custom Naming of a Station is applicable for both Tuner 1 and the optional secondary Tuner 2 Module.

1. Momentarily press and release the Front Panel ENTER

How to Assign Preset Stations and Custom Names

push-button. The LED above the ENTER push-button will light.

2. Select Station Preset Number 1, by rotating the PRESET Knob clockwise or counterclockwise.
3. Push the DISPLAY Push-button and the Front Panel Display of the Station Frequency (default) will be replaced by “1”, a blank space, and then a flashing “A”. Refer to figure 7.



Figure 7

Note: The number 1 is the assigned Preset Number followed by the first of eight possible characters of the new Assigned Preset Name.

4. Rotate the TUNING Knob clockwise to scroll through the alphabet until the character “J” appears. Refer to figure 8.



Figure 8

5. Rotate the PRESET Knob clockwise until the “A” appears to the right of the “J”. Refer to figure 9.



Figure 9

6. Rotate the PRESET Knob clockwise again until the “A” appears to the right of the “JA”.
7. Rotate the TUNING Knob clockwise to scroll through the alphabet until the character “Z” appears. Refer to figure 10.



Figure 10

8. Rotate the PRESET Knob clockwise again until the “A” appears to the right of the “JAZ”.
9. Repeat step 7 and refer to figure 11.



Figure 11

10. Rotate the PRESET Knob clockwise again until the “A” appears to the right of the “JAZZ”.
11. Rotate the TUNING Knob clockwise to scroll through the alphabet until *no* character appears.
12. Rotate the PRESET Knob clockwise again until the “A” appears to the right of the “JAZZ ”.
13. Rotate the TUNING Knob clockwise to scroll through the alphabet and numbers until the “7” digit appears. Refer to figure 12.



Figure 12

14. Press and release the front panel ENTER push-button a second time to store the newly assigned Preset Name into memory; the LED above the ENTER push-button will turn Off and the assigned Preset Name will appear on the Front Panel Display.

Note: If a Preset has been Custom Named, it is possible to restore the default Station Frequency Display if desired. Press the ENTER Push-button once, then press and hold the DISPLAY Push-button for 3 seconds.



Tuner 1 Preset Stations

Tuner 2 (Optional Module) Preset Stations

AM Station Presets			
Preset No.	Frequency	Call Letters	Name
1			
2			
3			
4			
5			
6			
7			
8			
9			

AM Station Presets			
Preset No.	Frequency	Call Letters	Name
1			
2			
3			
4			
5			
6			
7			
8			
9			

FM Station Presets			
Preset No.	Frequency	Call Letters	Name
1			
2			
3			
4			
5			
6			
7			
8			
9			

FM Station Presets			
Preset No.	Frequency	Call Letters	Name
1			
2			
3			
4			
5			
6			
7			
8			
9			

Information about the Optional TM1 Tuner Module

Cable for connection of the RAA1 to the MR85 AM Antenna 2 Jack

Hook-up cables for the McIntosh TM1 AM/FM Tuner Module

McIntosh RAA1 Remote AM Antenna

High Performance McIntosh AM/FM Tuner Module



Benefits of Adding the Second McIntosh AM/FM TM1 Tuner Module

- Adds the functionality of a second McIntosh Quality Tuner to your MR85 for a modest additional investment.
- Listen to one Radio Station while recording another.
- Add Multiroom enjoyment, listen to two different Radio Stations in different rooms of your home simultaneously.
- Your McIntosh Dealer can install the Second TM1 Tuner Module into your MR85 for you at any time, usually while you wait.



FM Tuner Specifications

Useable Sensitivity

14dB μ F which is 1.4 μ V across 75 ohms

50dB Quieting Sensitivity

Mono: 19dB μ F which is 2.4 μ V across 75 ohms

Stereo: 35dB μ F which is 15 μ V across 75 ohms

Signal To Noise Ratio

Mono: 75dB

Stereo: 70dB

Frequency Response

Mono: + 0, - 1dB from 20 to 15,000Hz

Stereo: + 0, - 1dB from 20 to 15,000Hz

Harmonic Distortion

Mono: 0.3% at 100Hz

0.3% at 1,000Hz

0.3% at 10,000Hz

Stereo: 0.45% at 100Hz

0.45% at 1,000Hz

0.65% at 10,000Hz

Intermodulation Distortion

Mono: 0.25%

Stereo: 0.45%

Capture Ratio

1.2dB

Alternate Channel Selectivity

75dB

Spurious Response

100dB

Image Response

75dB

RF Intermodulation

65dB

Stereo Separation

45dB at 100Hz

45dB at 1,000Hz

35dB at 10,000Hz

SCA Rejection

65dB

AM Tuner Specifications

Sensitivity

20 μ V External Antenna Input

Signal To Noise Ratio

48dB at 30% modulation

58dB at 100% modulation

Harmonic Distortion

0.5% maximum at 50% modulation

Frequency Response

50Hz to 6kHz NRSC

Adjacent Channel Selectivity

45dB minimum IHF

Image Rejection

65dB minimum from 540kHz to 1600kHz

IF Rejection

80dB minimum

General Specifications

Rated Output

Fixed output: 1.2 Volts

Variable output: 0 - 1.2 Volts

Output Impedance

Less than 100 ohms

Power Requirements

100 Volts, 50/60Hz at 20 watts

110 Volts, 50/60Hz at 20 watts

120 Volts, 50/60Hz at 20 watts

220 Volts, 50/60Hz at 20 watts

230 Volts, 50/60Hz at 20 watts

240 Volts, 50/60Hz at 20 watts

Note: Refer to the rear panel of the MR85 for the correct voltage.

Overall Dimensions

Width is 17-1/2 inches (44.5cm)

Height is 6 inches (15.3cm) including feet

Depth is 19 inches (48.3cm) including Front Panel and Knob

Weight

25.5 pounds (11.6 Kg) net, 43 pounds (19.5 Kg) in shipping carton

Packing Instructions

Packing Instructions

In the event it is necessary to repack the equipment for shipment, the equipment must be packed exactly as shown below. It is very important that the four plastic feet are attached to the bottom of the equipment. This will ensure the proper equipment location on the bottom pad. Failure to do this will result in shipping damage.

Use the original shipping carton and interior parts only if they are all in good serviceable condition. If a shipping carton or any of the interior part(s) are needed, please call or write Customer Service Repair Department of McIntosh Laboratory. Please see the Parts List for the correct part numbers.

Quantity	Part Number	Description
1	034125	Shipping carton only
2	033837	End Cap
2	034126	End Cap
1	034044	Corrugated Wrap
1	033836	Inside carton only
1	033725	Top Pad
1	034008	Bottom pad
1	034037	Inner carton pad
4	017218	Plastic foot
4	100159	#10-32 x 3/4" Machine screw
4	104083	#10 x 7/16" Flat washer
1	049259	Shipping carton complete with all the above parts

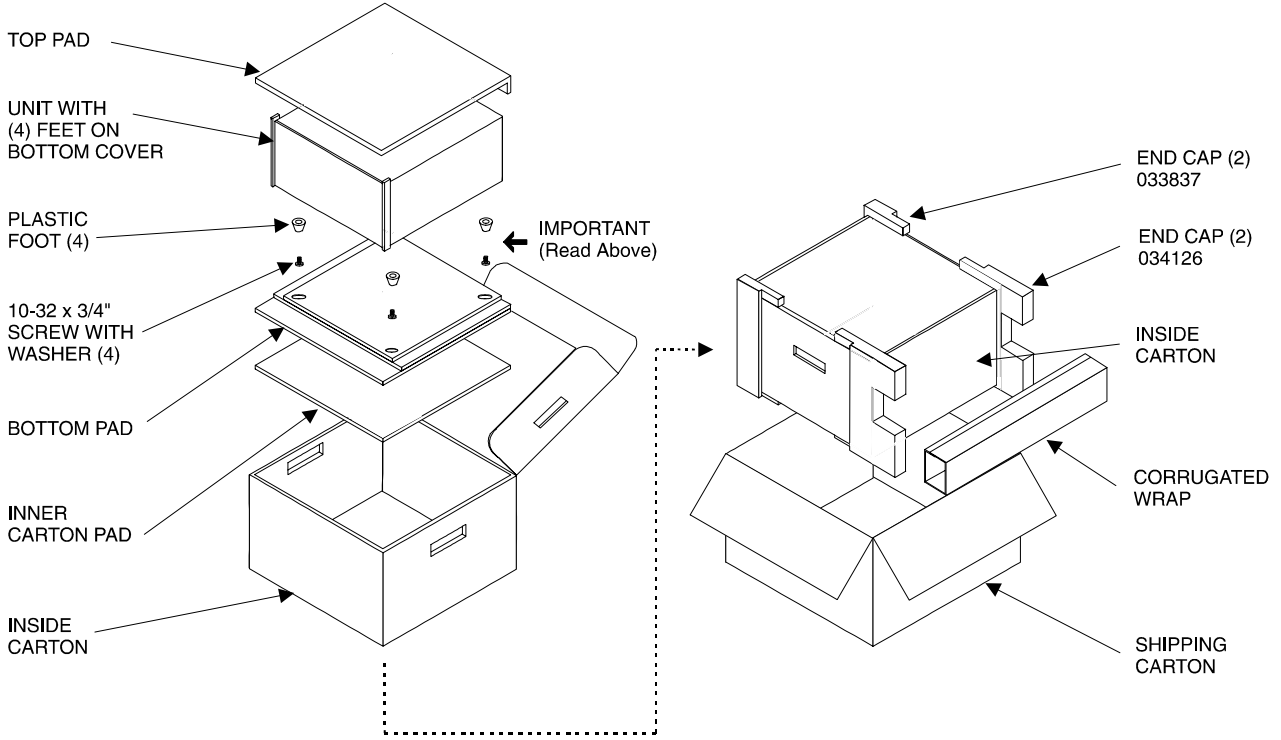



McIntosh Laboratory, Inc.
2 Chambers Street
Binghamton, NY 13903

The continuous improvement of its products is
the policy of McIntosh Laboratory Incorporated
who reserve the right to improve design without
notice.

Printed in the U.S.A.

McIntosh Part No. 04069802