



## Audio Video Player



Manufactured under license from Dolby Laboratories. "Dolby", "MLP Lossless" and the double-D symbol are trademarks of Dolby Laboratories.

"DTS" and "DTS Digital Surround" are registered trademarks of Digital Theater Systems, Inc.

This product incorporates copyright protection technology that is protected by U.S. patents and other intellectual property rights. Use of this copyright protection technology must be authorized by Macrovision, and is intended for home and other limited viewing uses only unless otherwise authorized by Macrovision. Reverse engineering or disassembly is prohibited.

## MVP861 Owner's Manual



The lightning flash with arrowhead, within an equilateral triangle, is intended to alert the user to the presence of uninsulated "dangerous voltage" within the product's enclosure that may be of sufficient magnitude to constitute a risk of electric shock to persons.



AVIS RISQUE DE CHOC ELECTRIQUE - NE PAS OUVRIR.

The exclamation point within an equilateral triangle is intended to alert the user to the presence of important operating and maintenance (servicing) instructions in the literature accompanying the appliance.

**WARNING - TO REDUCE RISK OF FIRE OR ELECTRICAL SHOCK, DO NOT EXPOSE THIS EQUIPMENT TO RAIN OR MOISTURE.**

**NO USER-SERVICEABLE PARTS INSIDE. REFER SERVICING TO QUALIFIED PERSONNEL.**

To prevent the risk of electric shock, do not remove cover or back. No user serviceable parts inside.

**CAUTION** - Invisible Laser Radiation when open. DO NOT stare into the beam or view directly with optical instruments. Use of controls or adjustments or performance of procedures other than those specified in the Owners Manual may result in Hazardous Radiation Exposure.

**LUOKAN 1 LASERLAITE  
KLASS 1 LASER APPARAT**

**VAROITUS!** Laitteen käyttäminen muulla kuin tassa käyttöohjeessa mainitulla tavalla saattaa altistaa käyttäjän turvallisuusluokan 1 ylittävälle näkymättömälle lasersäteilylle.

**WARNING!** Om apparaten används på annat sätt än i denna bruksanvisning specificerats, kan användaren utsättas för osynlig laserstrålning, som överskrider gränsen för laserklass 1.

This product incorporates an embedded **CLASS 3R Laser (IEC60825-1).**

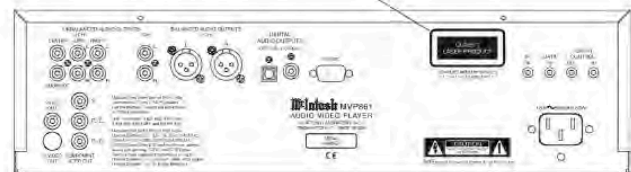
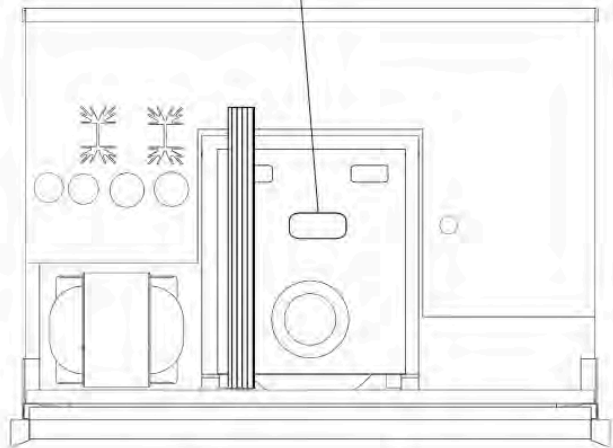
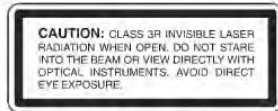

---

## **IMPORTANT SAFETY** **INSTRUCTIONS!**

### **PLEASE READ THEM BEFORE OPERATING THIS EQUIPMENT.**

1. Read these instructions.
2. Keep these instructions.
3. Heed all warnings.
4. Follow all instructions.
5. Do not use this apparatus near water.
6. Clean only with a dry cloth.
7. Do not block any ventilation openings. Install in accordance with the manufacturer's instructions.
8. Do not install near any heat sources such as radiators, heat registers, stoves, or other apparatus (including amplifiers) that produce heat.
9. Do not defeat the safety purpose of the polarized or grounding-type plug. A polarized plug has two blades with one wider than the other. A grounding type plug has two blades and a third grounding prong. The wide blade or the third prong are provided for your safety. If the provided plug does not fit into your outlet, consult an electrician for replacement of the obsolete outlet.
10. Protect the power cord from being walked on or pinched particularly at plugs, convenience receptacles, and the point where they exit from the apparatus.
11. Only use attachments/accessories specified by the manufacturer.
12. Use only with the cart, stand, tripod, bracket, or table specified by the manufacturer, or sold with the apparatus. When a cart is used, use caution when moving the cart/apparatus combination to avoid injury from tip-over.
13. Unplug this apparatus during lightning storms or when unused for long periods of time.
14. Refer all servicing to qualified service personnel. Servicing is required when the apparatus has been damaged in any way, such as power-supply cord or plug is damaged, liquid has been spilled or objects have fallen into the apparatus, the apparatus has been exposed to rain or moisture, does not operate normally, or has been dropped.
15. Do not expose this equipment to dripping or splashing and ensure that no objects filled with liquids, such as vases, are placed on the equipment.
16. To completely disconnect this equipment from the a.c. mains, disconnect the power supply cord plug from the a.c. receptacle.
17. The mains plug of the power supply cord shall remain readily operable.





## Thank You

Your decision to own this McIntosh MVP861 Audio Video Player ranks you at the very top among discriminating music listeners. You now have "The Best." The McIntosh dedication to "Quality," is assurance that you will receive many years of musical enjoyment from this unit.

Please take a short time to read the information in this manual. We want you to be as familiar as possible with all the features and functions of your new McIntosh.

## Please Take A Moment

The serial number, purchase date and McIntosh Dealer name are important to you for possible insurance claim or future service. The spaces below have been provided for you to record that information:

**Serial Number:** \_\_\_\_\_

**Purchase Date:** \_\_\_\_\_

**Dealer Name:** \_\_\_\_\_

## Technical Assistance

If at any time you have questions about your McIntosh product, contact your McIntosh Dealer who is familiar with your McIntosh equipment and any other brands that may be part of your system. If you or your Dealer wish additional help concerning a suspected problem, you can receive technical assistance for all McIntosh products at:

McIntosh Laboratory, Inc.  
2 Chambers Street  
Binghamton, New York 13903  
Phone: 607-723-1545  
Fax: 607-772-3308

## Customer Service

If it is determined that your McIntosh product is in need of repair, you can return it to your Dealer. You can also return it to the McIntosh Laboratory Service Department. For assistance on factory repair return procedure, contact the McIntosh Service Department at:

McIntosh Laboratory, Inc.  
2 Chambers Street  
Binghamton, New York 13903  
Phone: 607-723-3515  
Fax: 607-723-1917

Copyright 2004 © by McIntosh Laboratory, Inc.

## Table of Contents

Safety Instructions .....	2
Thank You .....	4
Please Take a Moment .....	4
Technical Assistance and Customer Service .....	4
Table of Contents .....	4
Important Information .....	4
Connector Information .....	5
Introduction and Performance Features .....	6
Dimensions .....	7
Installation .....	8
Rear Panel Connections .....	9
How to Connect Control, Analog and Digital Audio .....	10
How to Connect Video and AC Power .....	11
Front Panel Indicators and Push-Buttons .....	12
Front Panel Display .....	13
Remote Control Push-Buttons .....	14
How to Operate the Remote Control .....	15
How to Operate the Setup Mode .....	16
How to Operate .....	42
Specifications .....	54
Packing Instruction .....	55

## Important Information

- The following Connecting Cable is available from the McIntosh Parts Department:  
**Data and Power Control Cable Part No. 170-202**  
Six foot, shielded 2 conductor, with 1/8 inch stereo mini phone plugs on each end.*
- For additional connection information, refer to the owner's manual(s) for any component(s) connected to the MVP861 Audio Video Player.*
- The MVP861 has built-in 192kHz 24-Bit DACs (Digital to Analog Converter) to allow playing of DVDs recorded with a higher bit and sample rate, by using the Analog Audio Outputs.*
- Several of the DVD performance features available on the MVP861 are active only if the DVD includes the supporting encoded information.*
- The translucent Remote Control Push-buttons will illuminate for approximately 3 seconds when activated.*
- DVD-Video Discs are designed to only play in certain region(s) of the world. A region may be a single country or a group of countries. Usually on the back cover of the DVD-Video Disc container is a Globe Symbol with "Number(s)" or the word "All" inside it. The MVP861 is designed to play discs for Regions "1" and "All".*
- The MVP861 Audio Video Player is designed to play all standard CD Audio Discs that conform to the Official Compact Disc Standards which is indicated by the  Symbol. It will also play most CD-R and CD-RW discs, however some recorded discs may not be able to play due to the condition of the recording.*

## Important Information and Connector Information

### Important Information, con't

8. CD Audio Discs recorded in the MP3 Format will playback on the MVP861 except discs that contain multi-session recordings. The MP3 Digital Signal is decoded to analog audio by the internal circuitry and is available at the Audio Outputs. A PCM version of the decoded MP3 Signal is available at the Digital Audio Outputs.
9. The MVP861 will play Video CD Discs, DVD-R Discs, and DVD-RW discs, however some recorded discs may not be able to play due to the condition of the recording.
10. Compact Discs that are not round (e.g. Novelty discs with octagonal or heart shapes) will not play properly in the MVP861 and should not be tried, as possible damage may occur.
11. **CAUTION: DO NOT ACTIVATE** the MVP861 DVD Player's Progressive Video Display Mode unless you are certain that the TV/Monitor connected to the MVP861 is capable of displaying a Progressive Scan Signal. Failure to do so could result in possible damage to the TV/Monitor.
12. Some Multichannel DVD, DVD-Video, DVD-Audio and Super Audio Compact Discs might contain Low Frequency Audio Signals (below 80Hz) in the Center and/or Surround Channels. If the Loudspeakers in your sound system that reproduce the Center and/or Surround Channels are not capable of reproducing those Low Frequencies, distortion and/or possible damage to the Loudspeakers may occur. Refer to page 27 for correct settings. For additional information, consult with your Dealer or refer to the Owner's Manual for your Loudspeakers.
13. The DVD-Audio and Super Audio Compact Discs Audio Signals are converted internally from Digital to Analog. The Six Channel Analog Signals are available at the UNBALANCED AUDIO OUTPUTS 5.1CH.
14. Certain Dolby Digital and DTS Encoded Discs display their own unique Audio Mode Selection menu, every time the disc is loaded into the player. If you do not make a choice from this menu, the disc will revert to its default Audio Mode when play is started.
15. The MVP861 basic transport functions may also be controlled by using the Remote Control that comes with a McIntosh Control Center or Preamplifier. McIntosh Keypads can also be used to remotely control the basic transport functions of the MVP861. Remote Controls of certain McIntosh Control Centers or Preamplifiers also have additional Push-buttons including Direction Keys, Select, Title, Display and Menu that perform the same functions as the supplied MVP861 Remote Control. The labeling of Push-buttons on some McIntosh Remote Controls and Keypads are different from the supplied MVP861 Remote Control. Refer to the listing below:

<u>MVP861 Remote Control Push-button</u>	<u>McIntosh Remote Control/ Keypad Push-button</u>
Pause	E
+10	Review

### Important Information, con't



### Connector Information

#### XLR Connectors

Below is the Pin configuration for the XLR Balanced Output Connectors on the MVP861. Refer to the diagram for connection:

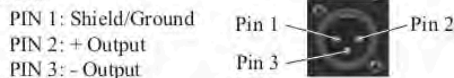

#### Power Control Connector

The MVP861 Power Control Input/Output Jacks provide Power On/Off Signals when connected to other McIntosh Components. A 1/8 inch stereo mini phone plug is used for connection to the Power Control Input/Output on the MVP861.

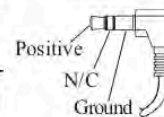

#### Data and IR Input Port Connectors

The MVP861 Data Port Output provides Remote Control Signals. A 1/8 inch stereo mini phone plug is used for connection to the Data Port Inputs on McIntosh Source Units. The IR Ports also use a 1/8 inch stereo mini phone plug and allow the connection of other brand IR Receivers to the MVP861.

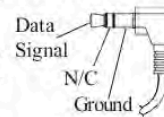

#### RS232 DB9 Connector Pin Layout

- |                   |        |
|-------------------|--------|
| 1. N/C            | 6. N/C |
| 2. Data Out (TXD) | 7. N/C |
| 3. Data In (RXD)  | 8. N/C |
| 4. N/C            | 9. N/C |
| 5. Gnd.           |        |

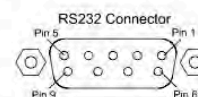



### Introduction

The McIntosh MVP861 Audio Video Player offers the latest in audio/video technology, providing state of the art reproduction of digital video and audio program sources. A full complement of performance features allows for the enjoyment of the special audio and video formats available on DVDs. Audio CDs are also reproduced with flawless realism. The advanced mechanical design of the transport ensures many years of smooth trouble free operation.

### Performance Features

#### • Twin Laser Pickup

The MVP861 incorporates two laser elements, with different wavelengths, that are focused through one lens assembly. This unique design allows reading many different types of Audio and Video Disc Formats.

#### • Advanced Transport

The MVP861 has a new vibration-resistant Transport with an advanced digital servo for faster, quieter and accurate operation. The DVD Data is read into memory from the disc at twice the normal rate. Likewise CD Audio Data is read into memory at four times the normal rate. The fast read speeds help to insure better disc tracking and error correction processing.

#### • Progressive Scan Video Output

The Component Video Output, with switchable Progressive Scan Processing, offers the highest possible picture quality available.

#### • Component, S-Video and Composite Video Output

The MVP861 has Component, S-Video and Composite Video Outputs for a variety of applications.

#### • Advanced Video Circuitry

An advanced technology 12-Bit DAC (Digital Analog Converter) operating at 108MHz, with over 500 lines of horizontal resolution capability, performs video signal processing for enhanced DVD picture quality.

#### • Digital Super Sub Alias Filter with Noise Shaped Video

Selectively removes only the noise components from the signal for a clear image reproduction.

#### • DVD-Audio and Super Audio Disc Playback

The MVP861 plays DVD-Audio Discs and Super Audio Disc (SACD) that have higher resolution sound quality, plus the capability of multichannel sound reproduction.

#### • 24 BIT Burr Brown Audio DAC

The MVP861 has three built-in Burr Brown 2-channel Digital to Analog Converters are capable of sampling rates up to 192kHz with 24 Bits of resolution.

#### • Balanced Outputs

The MVP861 has Balanced Outputs for the Left and Right Channels when playing a CD. When a Multichannel DVD Audio or SACD Disc is playing, the Balanced Left and Right Outputs provide a two channel mix down of the Multichannel Recording.

#### • Built-in Dolby Digital and DTS Digital Decoders

The MVP861 provides built-in decoding of Dolby Digital and DTS Digital Sound Tracks.

#### • Digital Audio Outputs

There are Coaxial and Optical Digital Outputs for external decoding of Dolby Digital, DTS Digital Signals, PCM or MP3 Signals from CDs.

#### • On Screen Audio Calibration

Internal Level and Time Delay Adjustments are available for Dolby Digital, DTS Digital, DVD-Audio and SACD Disc Signals and effect the multichannel analog audio outputs.

#### • On Screen Menu Icons

This feature allows control of a variety of settings via Remote Control.

#### • Special Power Supply

A fully regulated Power Supply, with a special R-Core Power Transformer, ensures stable noise free operation even though the power line varies.

#### • Fiber Optic Solid State Front Panel Illumination

The Illumination of the Glass Front Panel is accomplished by the combination of custom designed Fiber Optic Light Diffusers and extra long life Light Emitting Diodes (LEDs). This provides even Front Panel Illumination and is designed to ensure the pristine beauty of the MVP861 will be retained for many years.

**MVP861 Dimensions**

The following dimensions can assist in determining the best location for your MVP861. There is additional information on the next page pertaining to installing the MVP861 into cabinets.

**Front View of the MVP861**



**Rear View of the MVP861**

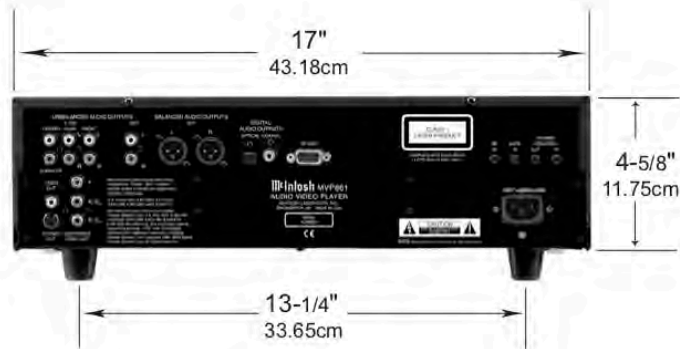

**Side View of the MVP861**

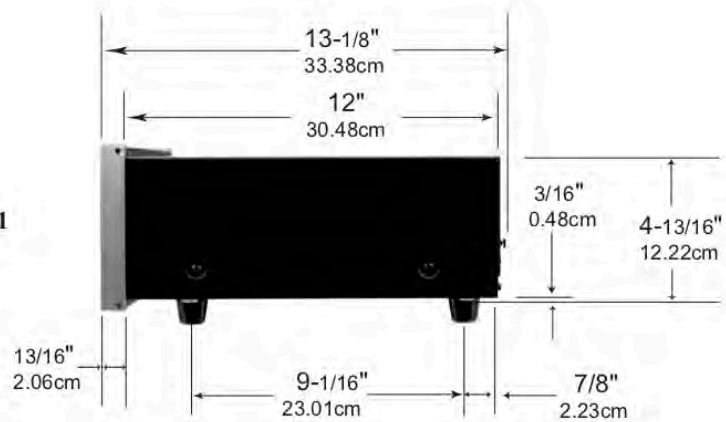



### Installation

The MVP861 can be placed upright on a table or shelf, standing on its four feet. The four feet, may be removed from the bottom of the MVP861 when it is custom installed as outlined below. The four feet, together with the mounting screws should be retained for possible future use if the MVP861 is removed from the custom installation and used free standing. It also can be custom installed in a piece of furniture or cabinet of your choice. The required panel cutout, ventilation cutout and unit dimensions are shown.

Always provide adequate ventilation for your MVP861.

Cool operation ensures the longest possible operating life for any electronic instrument. Do not install the MVP861 directly above a heat generating component such as a high powered amplifier. If all the components are installed in a single cabinet, a quiet running ventilation fan can be a definite asset in maintaining all the system components at the coolest possible operating temperature.

A custom cabinet installation should provide the following minimum spacing dimensions for

cool operation. Allow at least 2 inches (5.08 cm) above the top, 2 inches (5.08cm) below the bottom and 1 inch (2.54 cm) on each side of the DVD Player, so that airflow is not obstructed. Allow 15 inches (38.1 cm) depth behind the front panel. Allow 1 inch (2.54 cm) in front of the mounting panel for clearance. When the DVD/CD tray is opened, the panel clearance required in front of mounting panel is 6-3/4 inches (17.2cm). Be sure to cut out a ventilation hole in the mounting shelf according to the dimensions in the drawing.

**MVP861 Front Panel Custom Cabinet Cutout**



Cutout Opening for Custom Mounting

**MVP861 Side View in Custom Cabinet**

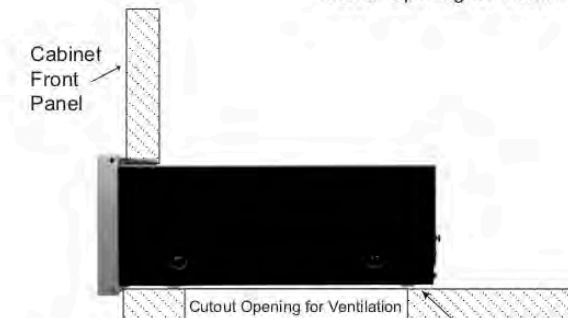

**MVP861 Bottom View in Custom Cabinet**

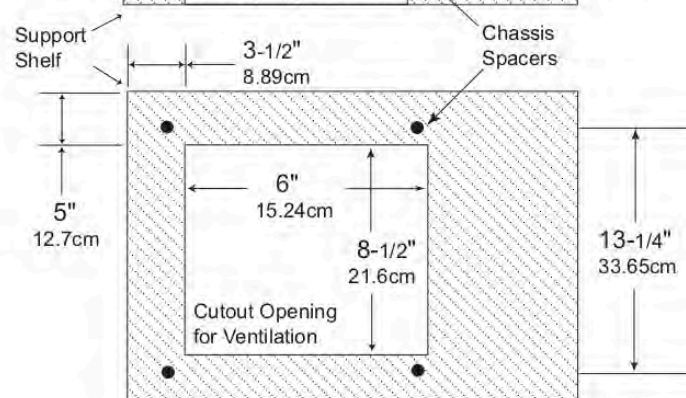



## Rear Panel Connections

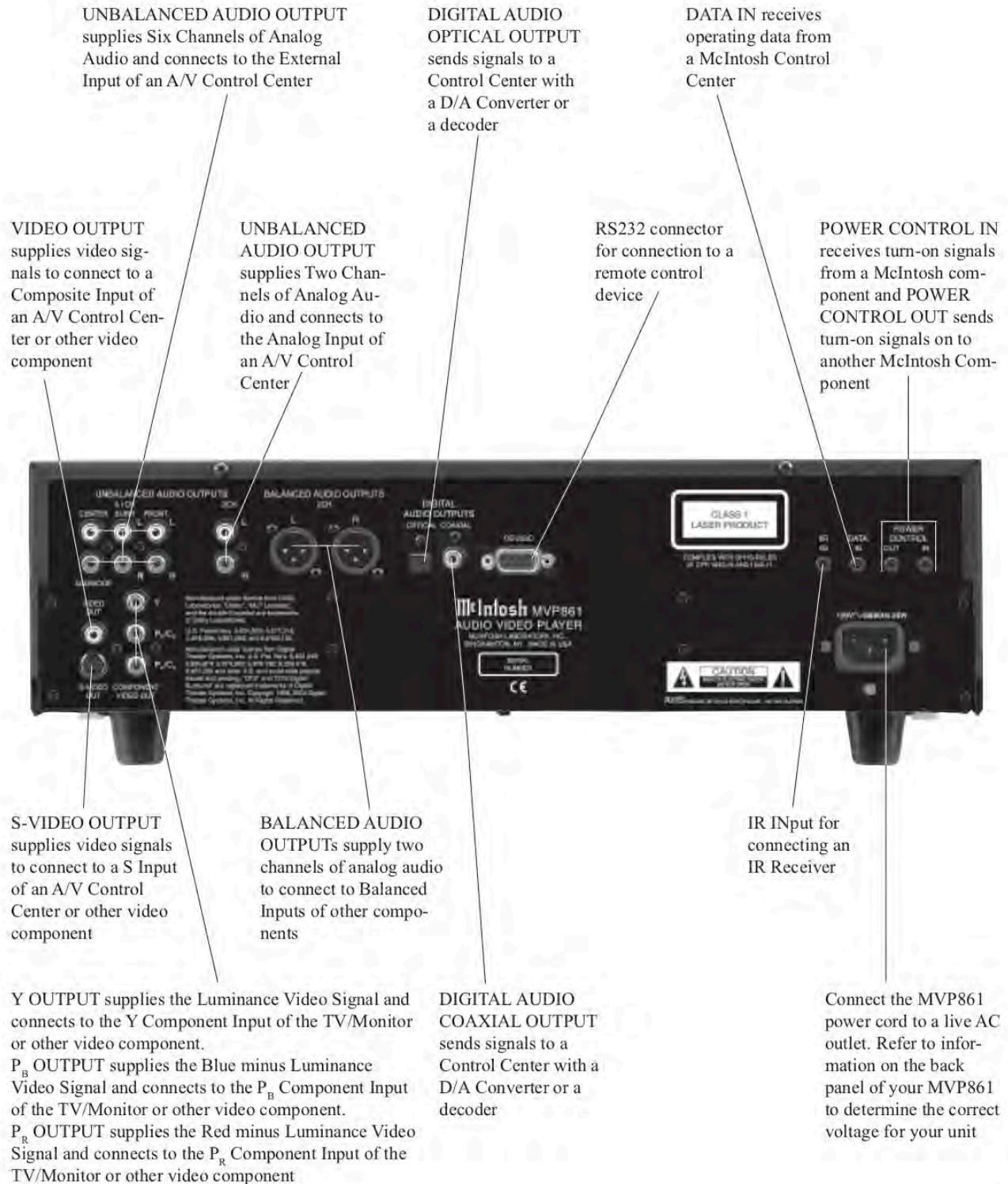



### How to Connect Control, Analog and Digital Audio

1. Connect a Power Control Cable from the MVP861 POWER CONTROL IN to the POWER CONTROL ACC Output jack of a McIntosh A/V Control Center.
2. Connect a Data Cable from the MVP861 DATA IN jack to the DVD DATA jack on the McIntosh A/V Control Center.
3. Connect a Coaxial Cable from the MVP861 DIGITAL AUDIO COAXIAL OUTPUT to the DVD Coaxial DIGITAL INPUT of a McIntosh A/V Control Center.

*Note: An optional connecting method is to use an optical cable from the MVP861 DIGITAL AUDIO OPTICAL OUTPUT to the Optical Digital Input of a McIntosh A/V Control Center.*

4. Connect Audio Cables from the MVP861 UNBALANCED 2CH AUDIO OUTPUTS to the DVD Inputs on a McIntosh A/V Control Center.
5. Optionally connect Audio Cables from the MVP861 BALANCED 2CH AUDIO OUTPUTS to the Zone A Balanced 1 Inputs on a McIntosh A/V Control Center.
6. Connect Audio Cables from the MVP861 UNBALANCED 5.1CH AUDIO OUTPUTS (all six channels) to the External AUDIO INPUTS on a McIntosh A/V Control Center.

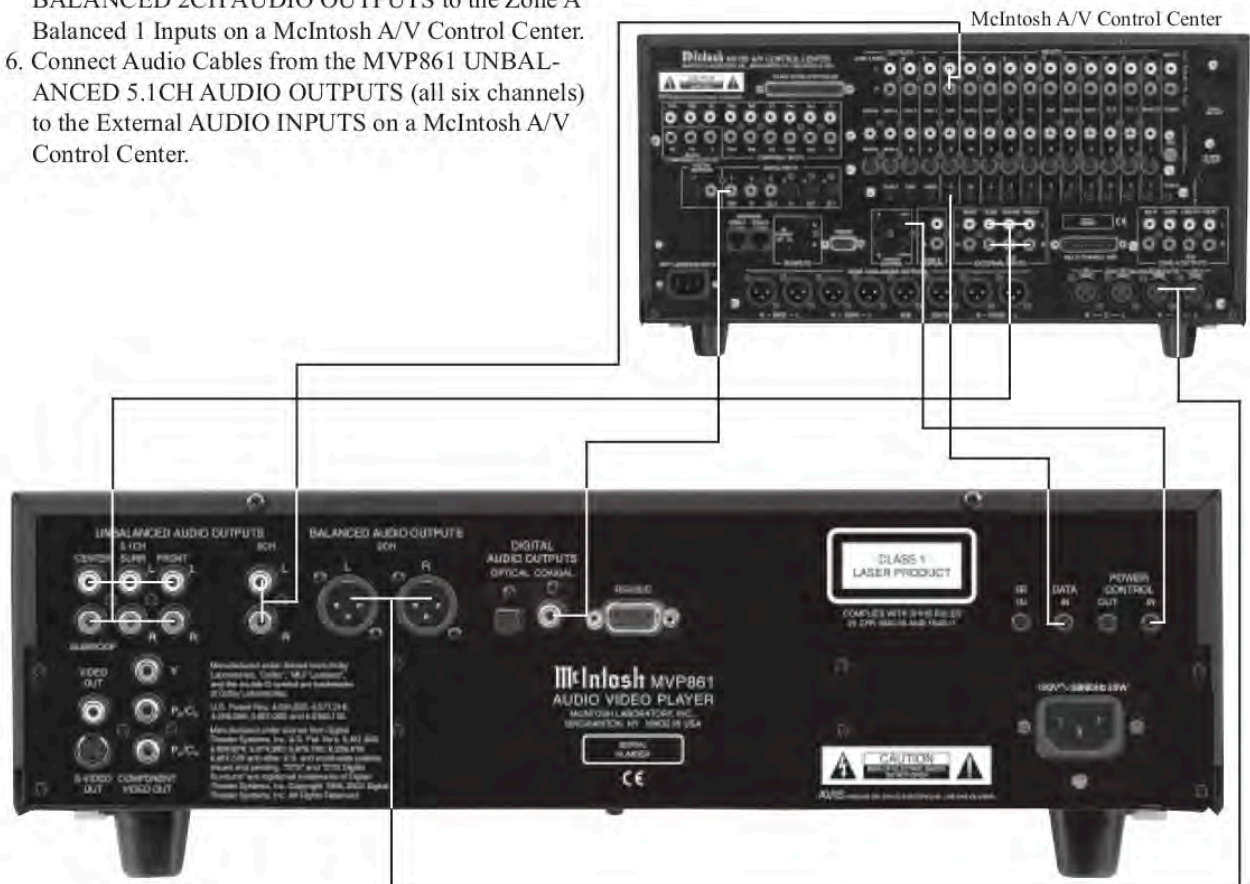

## How to Connect Video and AC Power

### How to Connect Video and AC Power

1. Connect a S-Video Cable from the MVP861 S-VIDEO OUTPUT to the DVD S-VIDEO INPUT on a McIntosh A/V Control Center.

*Note: The MVP861 Video Outputs may also be connected directly to a Monitor/TV if no Video Input Switching is available in the A/V Control Center.*

2. Connect a Video Cable from the MVP861 Composite VIDEO OUTPUT to the Multizone Controller V-DVD Video Input. Connect a Video Cable from the Multizone Controller V-DVD VIDEO OUTPUT to the A/V Control Center DVD Composite DVD VIDEO INPUT.

*Note: If a McIntosh Multizone Controller is not used, connect MVP861 Composite VIDEO OUTPUT to the A/V Control Center DVD Composite DVD VIDEO INPUT.*

3. If you have an Audio/Video Control Center with Component Video Inputs, connect it as follows. If the Audio/Video Control Center does not have provisions for Component Video Switching, proceed to step 4 below.

- A. Connect a video cable from the MVP861 Y OUTPUT to the Component Video Input of the McIntosh A/V Control Center.

- B. Connect a video cable from the MVP861 P<sub>B</sub>/C<sub>B</sub> OUTPUT to the P<sub>B</sub> Component Video Input of the McIntosh A/V Control Center.

- C. Connect a video cable from the MVP861 P<sub>R</sub>/C<sub>R</sub> OUTPUT to the P<sub>R</sub> Component Video Input of the McIntosh A/V Control Center.

4. If you have a TV/Monitor and/or other Video Component with Component Video Inputs then connect as follows:

- A. Connect a video cable from the MVP861 Y OUTPUT to the Y Component Video Input of the TV/Monitor or other video component.

- B. Connect a video cable from the MVP861 P<sub>B</sub>/C<sub>B</sub> OUTPUT to the P<sub>B</sub> Component Video Input of the TV/Monitor or other video component.

- C. Connect a video cable from the MVP861 P<sub>R</sub>/C<sub>R</sub> OUTPUT to the P<sub>R</sub> Component Video Input of the TV/Monitor or other video component.

5. Connect the MVP861 power cord to a live AC outlet.

*Note: When AC Power is initially applied to the MVP861 the unit will momentarily switch On and then go into the Standby Mode.*

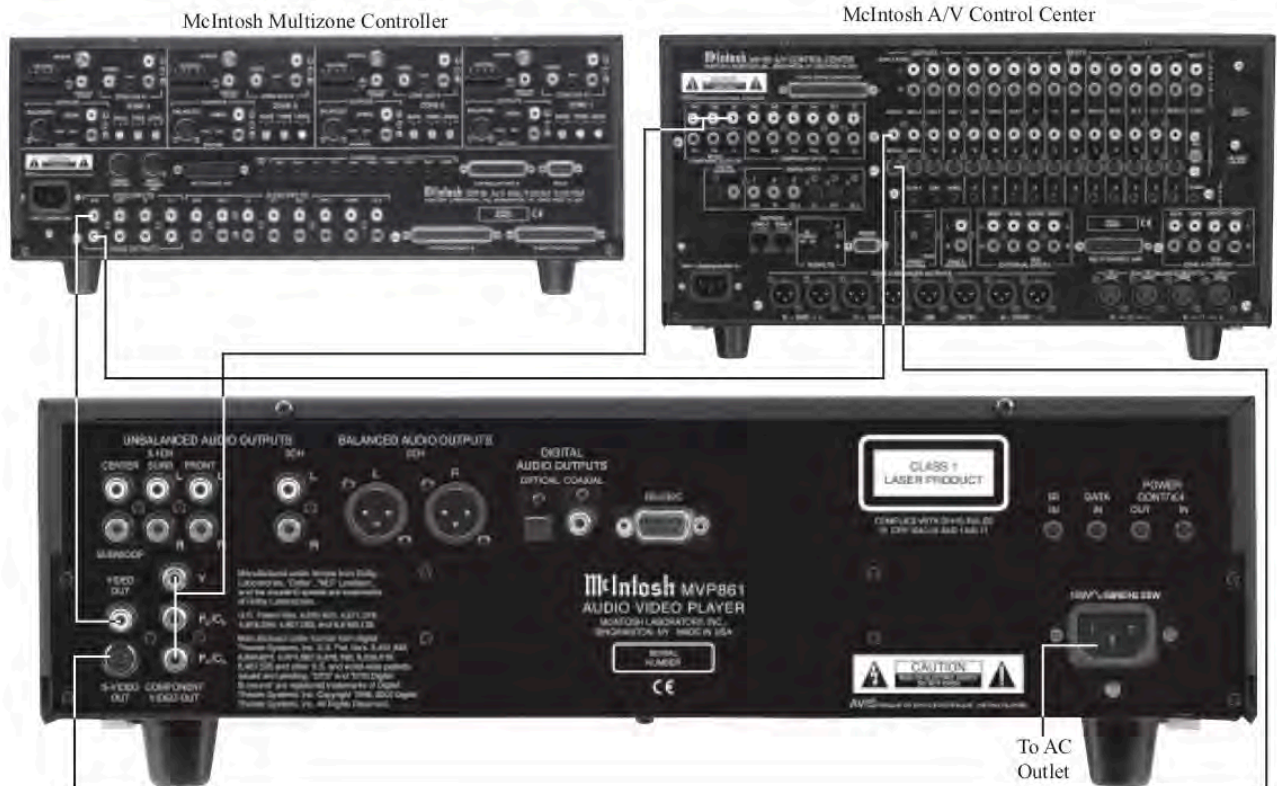



## Front Panel Indicators, Push-Buttons and Switch

Indicates when a Super Audio Compact Disc (SACD) is loaded or playing back

Disc Tray opens to load and unload a disc

Standby Power On Indicator

Front Panel Alphanumeric and Symbol Display

IR Sensor receives commands from a Remote Control



Selects the SACD Multichannel Audio Tracks, SACD Stereo Audio Tracks or CD Audio Tracks from a hybrid disc

Move rapidly forward through a disc during playback

Move forward one track/chapter at a time

Use to Pause during playback

Opens and Closes the disc tray for loading or unloading discs

Move rapidly backward through a disc during playback

Move back one track/chapter at a time

Stops disc playback

Starts disc playback

STANDBY/ON Push-button switches the MVP861 ON or OFF (Standby) and resets the microprocessors

## Front Panel Display

Indicates the type of disc loaded; CD, CD-Video, DVD, DVD-Audio, or DVD-Video

Indicates when the two digits below are displaying the Group or Title Number

Indicates the type of Digital Signal being decoded by the MVP861; which includes DTS, Dolby Digital, Packed Pulse Code Modulation (PCM), Linear PCM, MPEG and MP3.

Indicates the type of the Source Video Signal Source; F for (Film based), V for (Video based) or G for (Graphic based)

Indicates the current Multi-Channel Sound track can be down mixed to 2 Channels

Indicates when the two digits below are displaying the Track or Chapter Number

Indicates the channels of sound available on the disc; which includes Front Left, Front Center, Front Right, Surround Left, Mono Surround, Surround Right and Low Frequency Effect Channel

Indicates when the disc contains multiple viewing angles



Indicates when the Play Mode is active

Indicates when in the Pause Mode

Indicates Track or Chapter Number of the Disc

Indicates the Progressive Scan Video Processing Circuit is active

Indicates the Random Play Mode is active

Indicates the Preselected Track Play Mode is active

Indicates Title Number on the Disc and the Group Number on DVD-Audio Discs

Indicates the current Track Time, Remaining Track Time, Total Disc Playing Time and various other Information

Indicates the Repeat Mode selected; Repeat All, Repeat ITrack or Repeat from point A to point B on the disc



## Remote Control Push-Buttons

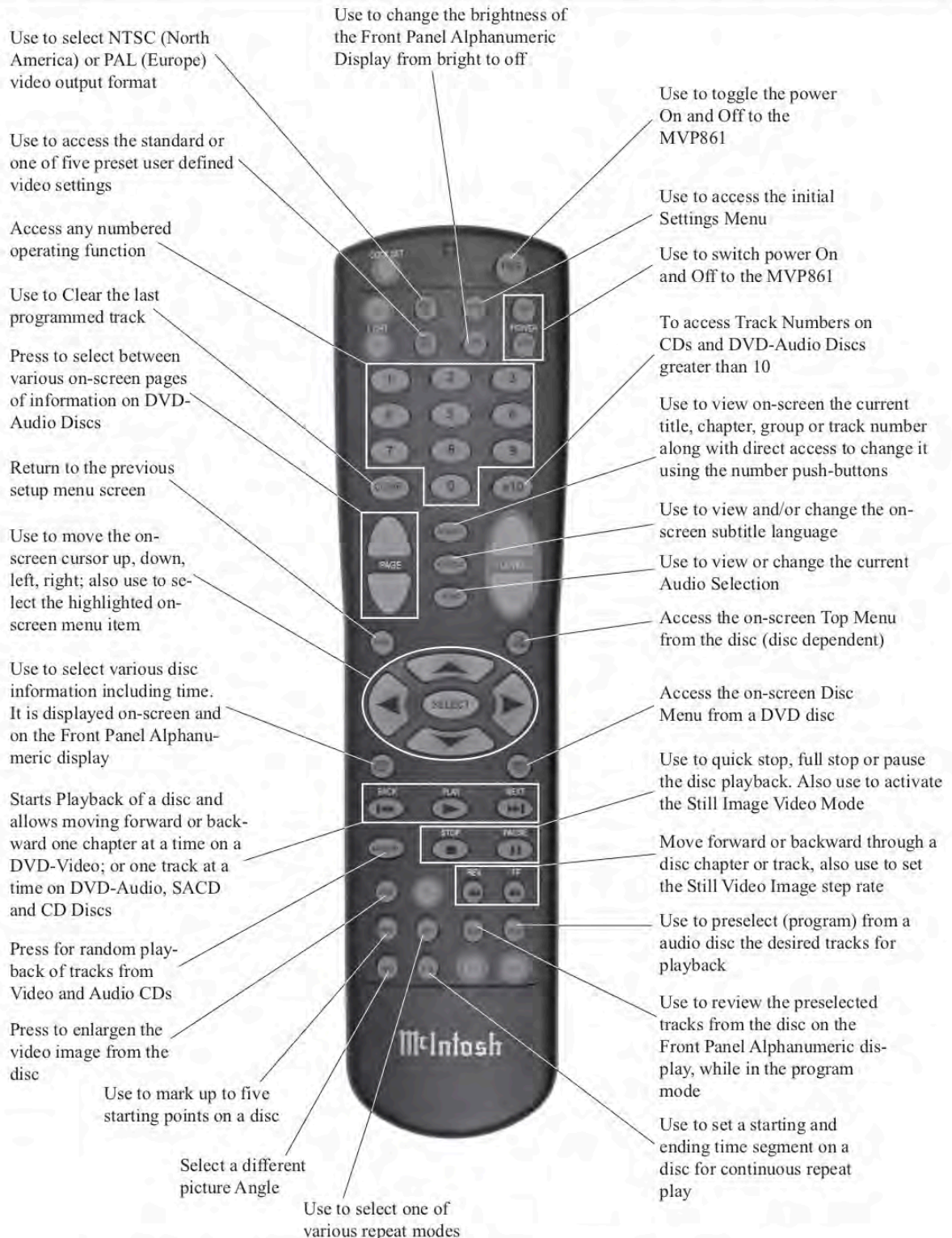

*Note: The Remote Control push-buttons that are "grayed out" are for use with other McIntosh Products.*

### How to Operate the Remote Control

The Remote Control is capable of performing both basic Operating Functions and Setup Options for the MVP861 Disc Player.

*Notes: Refer to the "How to Operate" and "How to Operate Setup Mode" Sections of this manual for additional information using this Remote Control. The NTSC/PAL, PIC ADJ, SETUP, DIM, and POWER ON/OFF push-buttons will only send their commands to the MVP861 after the push-button is released.*

#### Play

With a disc loaded, press the PLAY ► push-button to start the disc playing.

#### Stop

Press the STOP ■ Push-button once to stop disc playback. Press PLAY and the disc will start playing again from the disc time where Stop was pressed. Press STOP ■ twice for a complete stop and return to the beginning of a disc.

#### Numbered Push-buttons

Press 1 through 9 to directly access one of the first nine Disc Tracks/Chapters using the On-screen Icon. For track numbers greater than 10, press the +10 Push-button first and then required number. For example to access Disc Track/Chapter 23, press +10 twice and then 3.

#### Clear

Press the CLEAR Push-button to erase a selected track or incorrect setting.

#### Pause

Press the PAUSE || Push-button to temporarily stop disc playback at any time. When a DVD is playing, each additional time the PAUSE push-button is pressed, the player will proceed to the next Still Video Image.

*Note: The Still Video Image step rate may be changed by using the REV (Reverse) ◀◀ or FF (Fast Forward) ▶▶ Push-button.*

#### Back and Next

Press the NEXT ▶▶| Push-button to move forward or the BACK ◀◀ Push-button to move backward one chapter/track at a time on the disc.

#### Return

Press the RTRN(Return) Push-button to return to the previous setup menu.

#### Setup

Press the SETUP Push-button to access the Initial Setup Menu.

#### Subtitle

Press the SUBTITLE Push-button to access the Subtitle menu and the Subtitle icon will appear at the top of the screen.

#### Marker

While a disc is playing, use the MRKR(Marker) Push-button to establish in memory up to five different starting points on a disc where you wish play to start.

#### Angle

If the DVD being played supports the Angle Feature, press the ANGLE Push-button to select the desired video picture angle.

#### Four Direction Arrows

Press an Arrow direction Push-button to move backward, forward, up or down through an on-screen menu.

#### Select

Press the SELECT Push-button to confirm and activate a setup option or options indicated by the on-screen icons.

*Note: The SELECT push-button is also referred to as "Return" when working within the Setup Mode.*

#### Top Menu

When a disc is loaded in the player, press the TOP MENU Push-button to access the main DVD Title menu (disc dependent).

#### Display/Time

Press the DISPlay/TIME Push-button to access various disc times, text information on SACD/CD and audio modes displayed on-screen (disc dependent).

#### Audio

Press the AUDIO Push-button to access various audio modes displayed on-screen (disc dependent).

#### REV and FF

Press a REV (Reverse) ◀◀ or FF (Fast Forward) ▶▶ Push-button to start moving rapidly through a chapter or track on a disc.

*Note: Audio level is automatically muted during this operating mode with a DVD disc.*

#### A-B Repeat

Press the A-B(Repeat) Push-button once to establish the starting point of the repeat loop and press the A-B(Repeat) Push-button a second time for the ending point, and that segment of a disc to be repeated continuously.



## How to Operate the Setup Mode

Your McIntosh MVP861 has been factory configured for default operating settings that will allow you to immediately enjoy superb video and high fidelity audio from a DVD-Video. It also reproduces DVD-Audio, SACDs and CDs with unparalleled sonic purity. If you wish to make changes to the factory default settings, a Setup feature is provided to customize the operating settings using On Screen Menus.

*Notes: The MVP861 must be connected to a MONITOR/TV either through an A/V Control Center or directly, for setup and use. The Remote Control supplied with the McIntosh MVP861 has several Push-buttons that are labeled differently than as indicated on the On Screen Menu, please refer to the following Setup Instructions in this Owner's Manual for the correct Push-button.*

1. The Red LED above the STANDBY/ON switch lights to indicate the MVP861 is in Standby mode. To Switch ON the MVP861, press the STANDBY/ON Push-button on the Front Panel or on the Remote Control either the PWR(Power) or POWER ON Push-button. Refer to figure 1.



Figure 1

*Note: When AC Power is initially applied to the MVP861 the unit will momentarily switch On and then go into the Standby Mode.*

2. Press the SETUP Push-button on the Remote Control and the DISC SETUP Menu will appear on the Monitor/TV screen. Refer to figures 2 & 3.

*Note: There are six Main Menu Icon Tabs located at the Top of the On-Screen Setup Display. The Icon Tabs are named Disc, OSD, Video, Audio, Ratings and Other.*

3. Access the desired Main Menu Icon Tab by pressing the Right▶ or Left◀ directional Push-buttons on the supplied Remote Control. Then use the Up▲ or Down▼ directional Push-buttons followed by the SELECT Push-button for the desired choice.

*Note: Some menu choices require more than one step to complete.*

4. The desired Menu Icon will then appear on the MONITOR/TV screen for further action. Follow the instructions for each of the desired setup menus.

5. After all setup adjustments are complete, press the SETUP Push-button to exit the Setup Mode.



Figure 2

Main Menu Icon Tabs



Figure 3



**Setup Mode Default Settings**

The following listings indicate the factory default settings. Refer to the listed page number for instructions on how to change a default setting.

**MAIN SETTINGS FOR:**

**Disc:**

<u>Name</u>	<u>Selection</u>	<u>Refer to Page</u>
Dialog .....	English .....	18
Subtitle .....	Off .....	18
Disc Menu .....	English .....	19

**OSD:**

<u>Name</u>	<u>Selection</u>	<u>Refer to Page</u>
OSD Language .....	English .....	20
Wall Paper .....	Blue .....	20

**Video:**

<u>Name</u>	<u>Selection</u>	<u>Refer to Page</u>
TV Aspect .....	Wide (16:9) .....	22
TV Type <sup>1</sup> .....	NTSC .....	22
Video Out .....	Interlaced .....	23
Still Mode .....	Automatic .....	24
Black Level .....	Lighter .....	25
Squeeze Mode .....	Off .....	25
Progressive Mode .....	Mode 1 .....	26

**Audio:**

<u>Name</u>	<u>Selection</u>	<u>Refer to Page</u>
Audio Channel .....	Multi-channel .....	27

**SPEAKER CONFIGURATION SETTINGS FOR:**

**Speaker Size:**

<u>Name</u>	<u>Selection</u>	<u>Refer to Page</u>
Front .....	Large .....	27
Center .....	Large .....	27
Subwoofer .....	Yes .....	27
Surround .....	Large .....	27
Filter .....	On .....	28

**Speaker Level:**

<u>Name</u>	<u>Initial Level</u>	<u>Refer to Page</u>
Front L ch .....	0dB .....	28
Center .....	0dB .....	28
Front R ch .....	0dB .....	28
Surround R ch .....	0dB .....	28
Surround L ch .....	0dB .....	28
Subwoofer .....	0dB .....	28

**Speaker Delay Time:**

<u>Name</u>	<u>Delay Time</u>	<u>Refer to Page</u>
Front L ch .....	12ft .....	28
Front R ch .....	12ft .....	30
Center .....	12ft .....	30
Surround L ch .....	10ft .....	30
Surround R ch .....	10ft .....	30
Subwoofer .....	12ft .....	30
Default .....	On .....	30

Super Audio CD .....	Multi .....	31
Digital Out .....	Normal .....	31
LPCM .....	Off .....	32
(44.1 kHz/ 48 kHz)		
Bass Enhancer .....	Off .....	33
(2 channel)		

**Ratings:**

<u>Name</u>	<u>Selection</u>	<u>Refer to Page</u>
Rating Level .....	No Limit .....	34
Password .....	0000 .....	36

**Others Setup:**

<u>Name</u>	<u>Selection</u>	<u>Refer to Page</u>
Player Mode .....	Audio .....	38
Captions .....	Off .....	38
Compression .....	Off .....	39
Auto Power Mode .....	Off .....	40
Slide Show .....	5 sec .....	40

<sup>1</sup>The TV Type default setting for use in North America is NTSC and MULTI for use elsewhere.



## How to Set Disc Language

This is to select the Language of the Soundtrack, Subtitles, and Disc Menus.

### Dialog

This selects the dialog language that will be heard when the DVD Disc is played.

*Note: The Alternate Languages of French and Spanish may not be available on all DVD Discs.*

1. Press the SETUP Push-button on the supplied Remote Control to access the On-Screen Disc Setup Menu. Refer to figures 4 and 7.

*Note: If there is a Disc playing in the MVP861 press the STOP Push-button twice before pressing the SETUP Push-button.*

2. Use the Down▼ directional Push-button followed by the SELECT Push-button on the Remote Control to select the Dialog Menu.
3. To change the English setting to another language use the Up▲ or Down▼ directional Push-buttons followed by the SELECT Push-button.

*Notes: The title of the icon button-bar will change color from yellow (the cursor color) to green indicating the selected item. The choice of "Others" is for use outside of North America.*

4. Return to the Disc Setup Menu by pressing the Up▲ directional Push-button.
5. Next continue to the SUBTITLE Settings. If no other changes are to be made in Setup Mode at this time, exit by pressing the Down▼ directional Push-button to select the EXIT SETUP menu choice followed by the SELECT Push-button and the MVP861 will return to normal operation.

*Note: The SETUP Push-button may be also pressed to exit the setup mode.*

### Subtitle

This selects the language that will be seen on the TV/Monitor when a DVD Disc is played and the Subtitle Mode is active.

*Note: The Alternate Languages of French and Spanish may not be available on all DVD Discs.*

1. Press the SETUP Push-button on the supplied Remote Control to access the On-Screen Disc Setup Menu. Refer to figures 4 and 7.
2. Use the Down▼ directional Push-button followed by the SELECT Push-button on the Remote Control to select the Subtitle Menu.



Figure 4



Figure 5



Figure 6

3. The Subtitle Preference Menu will now appear on the screen with the default selection of Off. To change to Subtitle On select the desired language use the Up▲ or Down▼ directional Push-buttons followed by the SELECT Push-button. Refer to figure 5.

*Notes: The title of the icon button-bar will change color from yellow (the cursor color) to green indicating the selected item. The choice of "Others" is for use outside of North America.*

4. Return to the Disc Setup Menu by pressing the Up▲ directional Push-button.
5. Next continue to the MENU Settings. If no other changes are to be made in Setup Mode at this time, exit by pressing the Down▼ directional Push-button to select the EXIT SETUP menu choice followed by the SELECT Push-button and the MVP861 will return to normal operation.

*Note: The SETUP Push-button may be also pressed to exit the setup mode.*

#### Disc Menus

This selects the language of the menus that will be seen on the TV/Monitor.

*Note: The Alternate Languages of French and Spanish may not be available on all DVD Discs.*

1. Press the SETUP Push-button on the supplied Remote Control to access the On-Screen Disc Setup Menu. Refer to figures 4 and 7.
2. Use the Down▼ directional Push-button followed by the SELECT Push-button on the Remote Control to select the Disc Menu.
3. To change the English setting to another language use the Up▲ or Down▼ directional Push-buttons followed by the SELECT Push-button. Refer to figure 6.

*Notes: The title of the icon button-bar will change color from yellow (the cursor color) to green indicating the selected item. The choice of "Others" is for use outside of North America.*

4. Return to the Disc Setup Menu by pressing the Up▲ directional Push-button.
5. Next continue to the OSD Settings. If no other changes are to be made in Setup Mode at this time, exit by pressing the Down▼ directional Push-button to select the EXIT SETUP menu choice followed by the SELECT Push-button and the MVP861 will return to normal operation.

*Note: The SETUP Push-button may be also pressed to exit the setup mode.*



Figure 7



## How to Set the OSD (On Screen Display)

### OSD Language

This selects the language of the on screen menus that will be seen on the TV/Monitor. To change from English to another language perform the following steps:

*Note: The Alternate Languages of French and Spanish may not be available on all DVD Discs when viewing their menus.*

1. Press the SETUP Push-button on the supplied Remote Control to access the On-Screen Disc Setup Menu. Then press the Right▶ directional Push-button to select the OSD Setup Menu Icon Tab. Refer to figures 8 and 11.

*Note: If there is a Disc playing in the MVP861 press the STOP Push-button twice before pressing the SETUP Push-button.*

2. Use the Down▼ directional Push-button followed by the SELECT Push-button on the Remote Control to select the OSD Language Menu. Refer to figure 9.
3. To change the English setting to another language use the Up▲ or Down▼ directional Push-buttons followed by the SELECT Push-button.

*Note: The title of the icon button-bar will change color from yellow (the cursor color) to green indicating the selected item.*

4. Return to the OSD Setup Menu by pressing the Up▲ directional Push-button.
5. Next continue to the WALL PAPER Settings. If no other changes are to be made in Setup Mode at this time, exit by pressing the Down▼ directional Push-button to select the EXIT SETUP menu choice followed by the SELECT Push-button and the MVP861 will return to normal operation.

*Note: The SETUP Push-button may be also pressed to exit the setup mode.*

### Wall Paper

This selects the Screen Background Color when the MVP861 is stopped and during the Setup Mode. To change from the default color of blue perform the following steps:

1. Press the SETUP Push-button on the supplied Remote Control to access the On-Screen Disc Setup Menu. Then press the Right▶ directional Push-button to select the OSD Setup Menu Icon Tab. Refer to figures 8 and 11.

*Note: If there is a Disc playing in the MVP861 press the STOP Push-button twice before pressing the SETUP Push-button.*

2. Use the Down▼ directional Push-button followed by the SELECT Push-button on the Remote Control to select the Wall Paper Menu. Refer to figure 10.



Figure 8



Figure 9



Figure 10





## How to Set the Video

### TV Aspect

This selects the proper display ratio of height and width to match the TV/Monitor connected to the MVP861. To change from the default setting of Wide (16:9) perform the following steps:

1. Press the SETUP Push-button on the Remote Control to access the On-Screen Disc Setup Menu. Then press the Right▶ directional Push-button to select the Video Setup Menu Icon Tab. Refer to figure 12.

*Note: If there is a Disc playing in the MVP861 press the STOP Push-button twice before pressing the SETUP Push-button.*

2. Use the Down▼ directional Push-button followed by the SELECT Push-button on the Remote Control to select the TV ASPECT Menu. Refer to figure 13.
3. To change from the Wide (16:9) setting use the Up▲ or Down▼ directional Push-buttons followed by the SELECT Push-button:

(16:9) Wide Screen Mode Format ..... refer to figure 14

(4:3 PS) Conventional Screen Mode

with Pan and Scan Format ..... refer to figure 15

(4:3 LB) Conventional Screen Mode

with Letter Box Format ..... refer to figure 16

*Note: The title of the icon button-bar will change color from yellow (the cursor color) to green indicating the selected item.*

4. Return to the Video Setup Menu by pressing the Up▲ directional Push-button.
5. Next continue to the TV TYPE Settings. If no other changes are to be made in Setup Mode at this time, exit by pressing the Down▼ directional Push-button to select the EXIT SETUP menu choice followed by the SELECT Push-button and the MVP861 will return to normal operation.

*Note: The SETUP Push-button may be also pressed to exit the setup mode.*

### TV Type

This selects the proper video signal format to match the capabilities of the connected TV/Monitor. To change from the default setting perform the following steps:

*Notes: The TV Type default setting for use in North America is NTSC and MULTI for use elsewhere. Refer to the TV/Monitor Owner's Manual to determine the correct setting to be used. If the incorrect setting is chosen the TV/Monitor may display an image without color and/or a loss of Horizontal/Vertical Synchronization.*

1. Press the SETUP Push-button on the supplied Remote Control to access the On-Screen Disc Setup Menu. Then press the Right▶ directional Push-button to select the Video Menu Icon Tab. Refer to figure 12.



Figure 12



Figure 13



Figure 14

*Note: If there is a Disc playing in the MVP861 press the STOP Push-button twice before pressing the SETUP Push-button.*

2. Use the Down ▼ directional Push-button followed by the SELECT Push-button on the Remote Control to select the TV TYPE Menu. Refer to figure 17.
3. To change from the default setting use the Up ▲ or Down ▼ directional Push-buttons followed by the SELECT Push-button.

*Note: The title of the icon button-bar will change color from yellow (the cursor color) to green indicating the selected item.*

4. Return to the Video Setup Menu by pressing the Up ▲ directional Push-button.
5. Next continue to the VIDEO OUT Settings. If no other changes are to be made in Setup Mode at this time, exit by pressing the Down ▼ directional Push-button to select the EXIT SETUP menu choice followed by the SELECT Push-button and the MVP861 will return to normal operation.

### Video Out

This selects the video signal format available at the Component Video Jacks to match the capabilities of the connected TV/Monitor. To change from the default setting of interlaced perform the following steps:

*Notes: The Progressive Scan Circuitry in the MVP861 offers the highest possible picture quality available when the Component Video Outputs of the MVP861 are connected to a TV/Monitor capable of Progressive Scan. Unlike a conventional TV with Odd and Even Scanning Lines that are interlaced together to form a picture, the Progressive Scanning Mode scans all the lines of picture information both Odd and Even at one time, non-interlaced.*

1. Press the SETUP Push-button on the Remote Control to access the On-Screen Disc Setup Menu. Then press the Right ► directional Push-button to select the Video Setup Menu Icon Tab. Refer to figure 12.

*Note: If there is a Disc playing in the MVP861 press the STOP Push-button twice before pressing the SETUP Push-button.*

2. Use the Down ▼ directional Push-button followed by the SELECT Push-button on the Remote Control to select the VIDEO OUT Menu. Refer to figure 18.

**CAUTION: DO NOT ACTIVATE the MVP681 DVD Player's Progressive Video Display Mode unless you are certain that the TV/Monitor connected to the MVP861 is capable of displaying a Progressive Scan Signal. Failure to do so could result in possible damage to the**



Figure 15



Figure 16



Figure 17



Figure 18



## How to Set the Video, con't

*TV/Monitor:* In order to view the Progressive Scan Video Output of the MVP861, the TV/Monitor connected to it must be capable of displaying a Progressive Picture and setup to display the Progressive Signal.

3. To change from the Interlaced to Progressive Scan setting use the Up▲ or Down▼ directional Push-buttons followed by the SELECT Push-button.

*Notes:* The title of the icon button-bar will change color from yellow (the cursor color) to green indicating the selected item. Not all High definition TV/Monitor sets are fully compatible with the MVP861 and may cause artifacts to be displayed in the picture. In the case of Progressive Scan picture problems, it is recommended to switch off the Progressive Scan feature in the MVP861 and instead use the built-in Progressive Scan feature of the TV/monitor. For additional information please contact your McIntosh Dealer.

4. Return to the Video Setup Menu by pressing the Up▲ directional Push-button.
5. Next continue to the STILL MODE Settings. If no other changes are to be made in Setup Mode at this time, exit by pressing the Down▼ directional Push-button to select the EXIT SETUP menu choice followed by the SELECT Push-button and the MVP861 will return to normal operation.

*Note:* The SETUP Push-button may be also pressed to exit the setup mode.

### Still Mode

The default setting of Automatic for the Still Mode of playback allows for the viewing a single video frame at a time. If you encounter video picture jittering or fuzzy small text with a certain disc, select Field or Frame to correct the problem. To change from the default setting perform the following steps:

1. Press the SETUP Push-button on the supplied Remote Control to access the On-Screen Disc Setup Menu. Then press the Right▶ directional Push-button to select the Video Setup Menu Icon Tab. Refer to figure 12 on page 22.

*Note:* If there is a Disc playing in the MVP861 press the STOP Push-button twice before pressing the SETUP Push-button.

2. Use the Down▼ directional Push-button followed by the SELECT Push-button on the Remote Control to select the STILL MODE Menu. Refer to figure 19.
3. To change from the default setting use the Up▲ or Down▼ directional Push-buttons followed by the SELECT Push-button.



Figure 19



Figure 20



*Note: The title of the icon button-bar will change color from yellow (the cursor color) to green indicating the selected item.*

4. Return to the Video Setup Menu by pressing the Up▲ directional Push-button.
5. Next continue to the BLACK LEVEL Settings. If no other changes are to be made in Setup Mode at this time, exit by pressing the Down▼ directional Push-button to select the EXIT SETUP menu choice followed by the SELECT Push-button and the MVP861 will return to normal operation.

*Note: The SETUP Push-button may be also pressed to exit the setup mode.*

### Black Level

The Black Level adjustment allows for changing the overall light to dark video level range to match up with the Monitor/TV capabilities. To change from the default setting perform the following steps:

1. Press the SETUP Push-button on the supplied Remote Control to access the On-Screen Disc Setup Menu. Then press the Right▶ directional Push-button to select the Video Setup Menu Icon Tab. Refer to figure 12 on page 22.

*Note: If there is a Disc playing in the MVP861 press the STOP Push-button twice before pressing the SETUP Push-button.*

2. Use the Down▼ directional Push-button followed by the SELECT Push-button on the Remote Control to select the BLACK LEVEL Menu. Refer to figure 20.
3. To change from the default setting use the Up▲ or Down▼ directional Push-buttons followed by the SELECT Push-button.

*Note: The title of the icon button-bar will change color from yellow (the cursor color) to green indicating the selected item.*

4. Return to the Video Setup Menu by pressing the Up▲ directional Push-button.
5. Next continue to the SQUEEZE MODE Settings. If no other changes are to be made in Setup Mode at this time, exit by pressing the Down▼ directional Push-button to select the EXIT SETUP menu choice followed by the SELECT Push-button and the MVP861 will return to normal operation.

*Note: The SETUP Push-button may be also pressed to exit the setup mode.*

### Squeeze Mode

There are two choices for viewing a Full Screen (4:3) DVD disc when the MVP861 is connected to a Wide Screen (16:9) Monitor/TV; full screen or center screen only. To



Figure 21

change from the default full screen setting perform the following steps:

*Note: The MVP861 needs to be in the Progressive Scan Mode and the Monitor/TV connected to the Component Video Outputs Jacks.*

1. Press the SETUP Push-button on the supplied Remote Control to access the On-Screen Disc Setup Menu. Then press the Right▶ directional Push-button to select the Video Setup Menu Icon Tab. Refer to figure 12 on page 22.

*Note: If there is a Disc playing in the MVP861 press the STOP Push-button twice before pressing the SETUP Push-button.*

2. Use the Down▼ directional Push-button followed by the SELECT Push-button on the Remote Control to select the SQUEEZE MODE Menu. Refer to figure 21.
3. To change from the default setting use the Up▲ or Down▼ directional Push-buttons followed by the SELECT Push-button.

*Note: The title of the icon button-bar will change color from yellow (the cursor color) to green indicating the selected item.*

4. Return to the Video Setup Menu by pressing the Up▲ directional Push-button.
5. Next continue to the PROGRESSIVE MODE Settings. If no other changes are to be made in Setup Mode at this time, exit by pressing the Down▼ directional Push-button to select the EXIT SETUP menu choice followed by the SELECT Push-button and the MVP861 will return to normal operation.

*Note: The SETUP Push-button may be also pressed to exit the setup mode.*



## How to Set the Video, con't

### Progressive Mode

In order to produce the best possible picture quality during video playback of very dark scenes, the MVP861 has an alternate Progressive Scan Video 2 Mode. To change from the default Progressive Scan Mode 1 setting perform the following steps:

*Note: The MVP861 needs to be in the Progressive Scan Mode and the Monitor/TV connected to the Component Video Outputs Jacks.*

1. Press the SETUP Push-button on the supplied Remote Control to access the On-Screen Disc Setup Menu. Then press the Right▶ directional Push-button to select the Video Setup Menu Icon Tab. Refer to figure 12.

*Note: If there is a Disc playing in the MVP861 press the STOP Push-button twice before pressing the SETUP Push-button.*

2. Use the Down▼ directional Push-button followed by the SELECT Push-button on the Remote Control to select the PROGRESSIVE MODE Menu. Refer to figure 22.
3. To change from the default setting use the Up▲ or Down▼ directional Push-buttons followed by the SELECT Push-button.

*Note: The title of the icon button-bar will change color from yellow (the cursor color) to green indicating the selected item.*

4. Return to the Video Setup Menu by pressing the Up▲ directional Push-button.
5. Next continue to the AUDIO SETUP Menu. If no other changes are to be made in Setup Mode at this time, exit by pressing the Down▼ directional Push-button to select the EXIT SETUP menu choice followed by the SELECT Push-button and the MVP861 will return to normal operation.

*Note: The SETUP Push-button may be also pressed to exit the setup mode.*



Figure 12



Figure 22

## How to Set the Audio

### Audio Channel

The MVP861 allows the configuring of various audio parameters to match the number, size and distance of Loudspeakers in the system.

1. Press the SETUP Push-button on the supplied Remote Control to access the On-Screen Disc Setup Menu. Then press the Right▶ directional Push-button to select the Audio Setup Menu Icon Tab. Refer to figure 23.

*Note: If there is a Disc playing in the MVP861 press the STOP Push-button twice before pressing the SETUP Push-button.*

2. Use the Down▼ directional Push-button to select AUDIO CHANNEL followed by pressing the SELECT Push-button on the Remote Control to select MULTI-CHANNEL. The Speaker Setup Menu will now appear On-Screen. Refer to figures 24 and 25.

*Notes: The title of the icon button-bar will change color from yellow (the cursor color) to green indicating the selected item. The following steps for Multichannel Loudspeaker Adjustments (Speaker Configuration, Channel Level and Delay Time) are also the same for a 2-Channel Loudspeaker System. In a 2-Channel System the On-Screen Menus that appear will have the non-connected Loudspeakers menu items grayed out.*

### LOUDSPEAKER SIZE CONFIGURATION:

In the steps below the size of the Loudspeakers will be entered into setup. The LARGE Setting refers to the Loudspeaker capability for reproducing bass frequencies down to 35Hz within -3dB of the midrange frequencies. If a Loudspeaker can not reproduce bass frequencies down to 35Hz within -3dB of the midrange frequencies it is considered SMALL.

1. Use the Down▼ directional Push-button to select SPEAKER CONFIGURATION followed by pressing the SELECT Push-button on the Remote Control. Refer to figure 26 on page 28.

*Note: If you do not wish to make Loudspeaker Adjustments at this time press the RTRN (Return) Pushbutton. Next continue to the SUPER AUDIO CD Menu by using the Down▼ directional Push-button.*

2. Press the Select push-button twice followed by using the Down▼ directional Push-button to select Large or Small Loudspeaker Size for the Front Loudspeakers connected in the system. Using the directional push-buttons and the On-Screen Menu proceed to the remaining Loudspeakers in the system and select Large, Small, None, On or Off.

*Note: If the Front Loudspeakers are set to small the*



Figure 23



Figure 24



Figure 25



## How to Set the Audio

*Center and Surround Loudspeaker will automatically switch to small with the Large Menu Setting grayed out. The Subwoofer setting will switch On with the Off Menu Setting grayed out.*

3. Use the Down ▼ directional Push-button to select FILTER followed by using the Down ▼ directional Push-button to select On or Off. When the Off position is selected the previously set Loudspeaker Size for the Front, Center and Surround will all change to the Large setting. The Subwoofer will switch to the On setting and all the Loudspeaker Menu Choices are grayed out. Refer to figure 27.
4. Press the RTRN (Return) Push-button to return to the SPEAKER CONFIGURATION Menu.

### CHANNEL LEVEL ADJUSTMENTS:

A properly setup Home Theater Surround Sound System should have all Loudspeaker levels adjusted to the same starting reference volume level in the Listening/Viewing Area. The MVP861 includes a built-in test signal generator, which can have its output switched into each Loudspeaker manually or automatically. The desired test signal volume levels of each Loudspeaker can be determined, in the Listening/Viewing Area, either by listening or with a sound pressure meter. Level adjustments are made in small steps (1dB) by using the MVP861 Remote Control Up ▲ or Down ▼ directional Push-buttons. The level can be adjusted over a 10dB range.

*Note: Before performing the Loudspeaker Level adjustments, you must first have completed the Loudspeaker Size adjustments.*

1. Use the Down ▼ directional Push-button to select CHANNEL LEVEL followed by pressing the SELECT Push-button on the Remote Control. Refer to figures 28 and 29.
2. Use the Down ▼ directional Push-button to select TEST TONE then press the Right ► or Left ◀ directional Push-buttons to select the MANUAL Selection Mode of operation. Refer to figures 30 and 31.

*Note: The procedure used for making the Loudspeaker Level Adjustments is similar for both the Manual and Automatic Modes. The only difference is, in the Manual Mode the selection of the Loudspeaker is performed by using the Up ▲ or Down ▼ directional Push-buttons before adjustments are made. In the Automatic Mode, the MVP861 will switch to the next Loudspeaker three seconds after user adjustments have stopped. Refer to figures 32 and 33 if the Automatic Mode will be used.*

3. Press the SELECT Push-button and then use the Right ► or Left ◀ directional Push-buttons to adjust the Loudspeaker Volume Level to match the volume level



Figure 26



Figure 27

of the other Loudspeakers. This may take several cycles through all the Loudspeakers to achieve the desired results. If one of the Loudspeakers is quieter than the others, use it as a reference to match the other loudspeakers to.

4. When all the Loudspeakers are at the same volume level press the RTRN (Return) Push-button to stop the Channel Level Adjustments and return to the SPEAKER CONFIGURATION Menu.

### DELAY TIME ADJUSTMENTS:

The following Delay Time Adjustments will electronically compensate for different Loudspeaker distances from the Listening/Viewing Area. Refer to figure 34 on page 30.



Figure 28



Figure 31



Figure 29



Figure 32



Figure 30



Figure 33



## How to Set the Audio, con't

Delay Time is measured in feet. The delays can be adjusted from 1 foot to 25 feet in one foot increments for each Loudspeaker.

*Note: Before performing the Delay Time adjustments, you must first have completed the Loudspeaker Size and Level adjustments.*

1. Measure the distances of the Loudspeakers used in the Home Theater System, from the Listening/Viewing Area to each Loudspeaker to within the nearest foot.

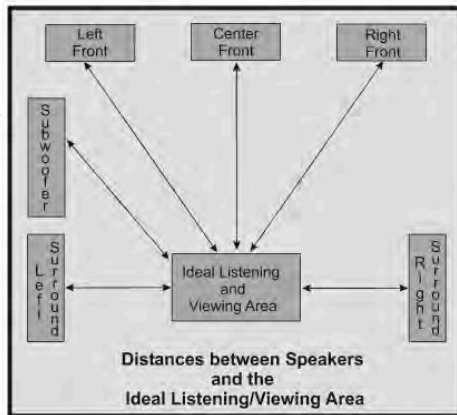

Figure 34

2. Use the Down▼ directional Push-button to select DELAY TIME followed by pressing the SELECT Push-button on the Remote Control. Refer to figures 35 and 36.
3. Use the Down▼ directional Push-button to select DISTANCE then press the Right▶ or Left◀ directional Push-buttons to select the desired measurement increments, either Feet or Meters.
4. Use the Down▼ directional Push-button to select FRONT Lch then use the Right▶ or Left◀ directional Push-buttons to enter in the distance of the Loudspeaker from the Listening/Viewing Area. Refer to figure 37.

*Note: The Menu choice of DEFAULT will reset all the Loudspeaker Delay Time settings.*

5. Enter in the distances for the remaining Loudspeakers.
6. When all the Loudspeakers distances are entered, press the RTRN (Return) Push-button for the SPEAKER CONFIGURATION Menu. Then use the Down▼ directional Push-button to select AUDIO SETUP.
7. Next continue to the SUPER AUDIO SETUP Menu item. If no other changes are to be made in Setup Mode at this time, exit by pressing the Down▼ directional Push-button to select the EXIT SETUP menu choice followed by the SELECT Push-button and the MVP861 will return to normal operation.

*Note: The SETUP Push-button may be also pressed to exit the setup mode.*



Figure 35



Figure 36



Figure 37

### Super Audio CD

The MVP861 allows the for establishing which sound format (disc layer) is choosen when a hybrid Super Audio Compact Disc (SACD) is played back. The default setting is for SACD Multichannel Audio Tracks; to change from the Multichannel Setting perform the following:

1. Press the SETUP Push-button on the supplied Remote Control to access the On-Screen Disc Setup Menu. Then press the Right▶ directional Push-button to select the Audio Setup Menu Icon Tab. Refer to figure 38.

*Note: If there is a Disc playing in the MVP861 press the STOP Push-button twice before pressing the SETUP Push-button.*

2. To change from the default setting use the Up▲ or Down▼ directional Push-buttons to select SUPER AUDIO CD followed by the SELECT Push-button. The Stereo setting selects the SACD 2-Channel Audio Tracks. Selecting CD will playback the standard CD Audio Tracks. Refer to figure 39.

*Notes: The title of the icon button-bar will change color from yellow (the cursor color) to green indicating the selected item. These settings may also be changed by using the Front Panel SACD/CD Push-button.*

3. Return to the Audio Setup Menu by pressing the Up▲ directional Push-button.
4. Next continue to the DIGITAL OUT SETUP Menu. If no other changes are to be made in Setup Mode at this time, exit by pressing the Down▼ directional Push-button to select the EXIT SETUP menu choice followed by the SELECT Push-button and the MVP861 will return to normal operation.

*Note: The SETUP Push-button may be also pressed to exit the setup mode.*

### Digital Out

If the MVP861 is connected to a Digital-to-Analog Processing unit without Dolby Digital or DTS decoding capabilities the Digital Output of the MVP861 can be set to output a 2-Channel Digital Audio Signal known as PCM, instead of the Normal Dolby Digital or DTS Digital Bitstream Digital Audio Signal. To change from the default setting perform the following steps:

1. Press the SETUP Push-button on the supplied Remote Control to access the On-Screen Disc Setup Menu. Then press the Right▶ directional Push-button to select the Audio Setup Menu Icon Tab. Refer to figure 38.

*Note: If there is a Disc playing in the MVP861 press the STOP Push-button twice before pressing the SETUP Push-button.*



Figure 38



Figure 39



Figure 40



## How to Set the Audio, con't

2. To change from the default setting of Normal to PCM use the Up▲ or Down▼ directional Push-buttons to select DIGITAL OUT followed by the SELECT Push-button. Refer to figure 40 on page 31.

*Notes: The title of the icon button-bar will change color from yellow (the cursor color) to green indicating the selected item.*

3. Return to the Audio Setup Menu by pressing the Up▲ directional Push-button.
4. Next continue to the LPCM (44.1kHz/48kHz) Menu. If no other changes are to be made in Setup Mode at this time, exit by pressing the Down▼ directional Push-button to select the EXIT SETUP menu choice followed by the SELECT Push-button and the MVP861 will return to normal operation.

*Note: The SETUP Push-button may be also pressed to exit the setup mode.*

### LPCM (44.1kHz/48kHz)

The MVP861's default setting is to make available at the Digital Outputs, the Digital Audio Signals of 96kHz or 88.2kHz from non-copyright protected DVDs. When the MVP861 is connected to a Digital-to-Analog Processing unit without the ability to process the higher digital sampling rate, the default setting can be changed to a 44.1kHz or 48kHz digital signal output by performing the following steps:

*Notes: If the disk is copyright protected, the MVP861 will down convert the Digital Audio Signal to 44.1kHz or 48kHz. The MVP861's internal digital to analog circuitry will always decode the highest sampling rate and will be available at the analog audio outputs.*

1. Press the SETUP Push-button on the supplied Remote Control to access the On-Screen Disc Setup Menu. Then press the Right▶ directional Push-button to select the Audio Setup Menu Icon Tab. Refer to figure 41.

*Note: If there is a Disc playing in the MVP861 press the STOP Push-button twice before pressing the SETUP Push-button.*

2. To change from the default setting of Off to On use the Up▲ or Down▼ directional Push-buttons to select LPCM (44.1kHz/48kHz) followed by the SELECT Push-button. Refer to figure 42.

*Notes: The title of the icon button-bar will change color from yellow (the cursor color) to green indicating the selected item.*

3. Return to the Audio Setup Menu by pressing the Up▲ directional Push-button.



Figure 41



Figure 42



Figure 43



4. Next continue to the BASS ENHANCER (2 channel) Menu. If no other changes are to be made in Setup Mode at this time, exit by pressing the Down ▼ directional Push-button to select the EXIT SETUP menu choice followed by the SELECT Push-button and the MVP861 will return to normal operation.

*Note: The SETUP Push-button may be also pressed to exit the setup mode.*

### **Bass Enhancer (2 Channel)**

The Bass Enhancer feature will copy the Low Frequency Information from the Left and Right Channels of a 2-Channel CD recording and send it to the Subwoofer. To activate the feature performing the following steps:

1. Press the SETUP Push-button on the supplied Remote Control to access the On-Screen Setup Disc Setup Menu. Then press the Right ► directional Push-button to select the Audio Setup Menu Icon Tab. Refer to figure 41.

*Note: If there is a Disc playing in the MVP861 press the STOP Push-button twice before pressing the SETUP Push-button.*

2. To change from the default setting of Off to On use the Up ▲ or Down ▼ directional Push-buttons to select BASS ENHANCER followed by the SELECT Push-button. Refer to figure 43.

*Notes: The title of the icon button-bar will change color from yellow (the cursor color) to green indicating the selected item.*

3. Return to the Audio Setup Menu by pressing the Up ▲ directional Push-button.
4. Next continue to the RATINGS Menu. If no other changes are to be made in Setup Mode at this time, exit by pressing the Down ▼ directional Push-button to select the EXIT SETUP menu choice followed by the SELECT Push-button and the MVP861 will return to normal operation.

*Note: The SETUP Push-button may be also pressed to exit the setup mode.*

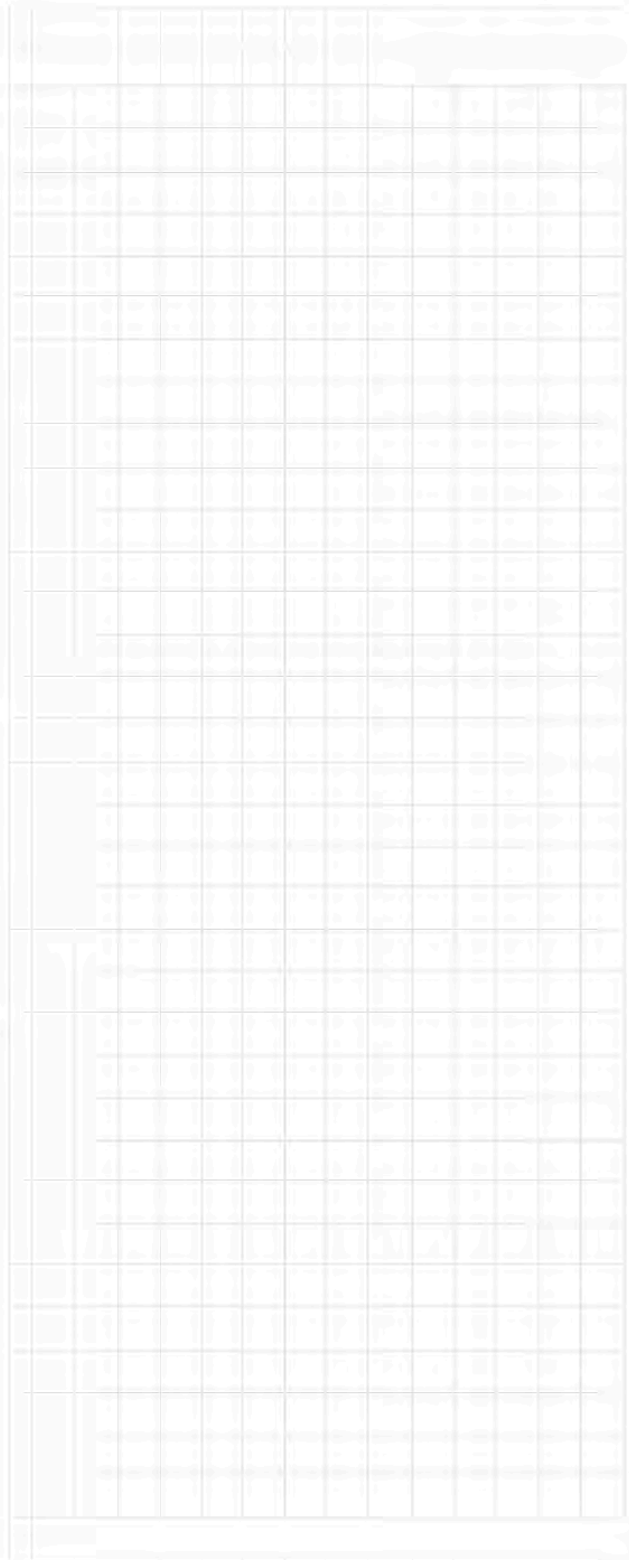



## How to Set the Ratings

### Rating Level

Some DVD Movie discs have encoded rating levels that allow setting the MVP861 to prevent children from viewing inappropriate movies in your absence. A password protected lock function, set by you, determines the rating limit for disc playback. In the example below the default setting of No Limit Rating Level will be changed to Level 3.

*Note: A Rating Level of 8 allows viewing of all DVD Movies and a Level of 1 plays movies suitable for children. It is advisable to write down the password for future reference, as once a password has been entered it will stay in effect until removed or changed.*

1. Press the SETUP Push-button on the supplied Remote Control to access the On-Screen Disc Setup Menu. Then press the Right▶ directional Push-button to select the Ratings Setup Menu Icon Tab. Refer to figure 44.

*Note: If there is a Disc playing in the MVP861 press the STOP Push-button twice before pressing the SETUP Push-button.*

2. Use the Down▼ directional Push-button to select RATING LEVEL followed by the SELECT Push-button. Select the desired rating level of 3 by using the Up▲ or Down▼ directional Push-buttons followed by the SELECT Push-button. Refer to figures 45 and 46.

*Notes: The title of the icon button-bar will change color from yellow (the cursor color) to green indicating the selected item.*

3. Using the NUMERIC Push-buttons on the Remote Control, enter the default password “0000” followed by SELECT Pushbutton. Refer to figures 47 and 48.
4. Press the Up▲ directional Push-button. Refer to figure 49.
5. Return to the Rating Menu by pressing the Up▲ directional Push-button.
6. Next continue to either changing the “Password” on page 36 or the OTHER SETUP Menu. If no other changes are to be made in Setup Mode at this time, exit by pressing the Down▼ directional Push-button to select the EXIT SETUP menu choice followed by the SELECT Push-button and the MVP861 will return to normal operation.

*Note: The SETUP Push-button may also be pressed to exit the setup mode.*



Figure 44



Figure 45



Figure 46



Figure 47



Figure 48



Figure 49

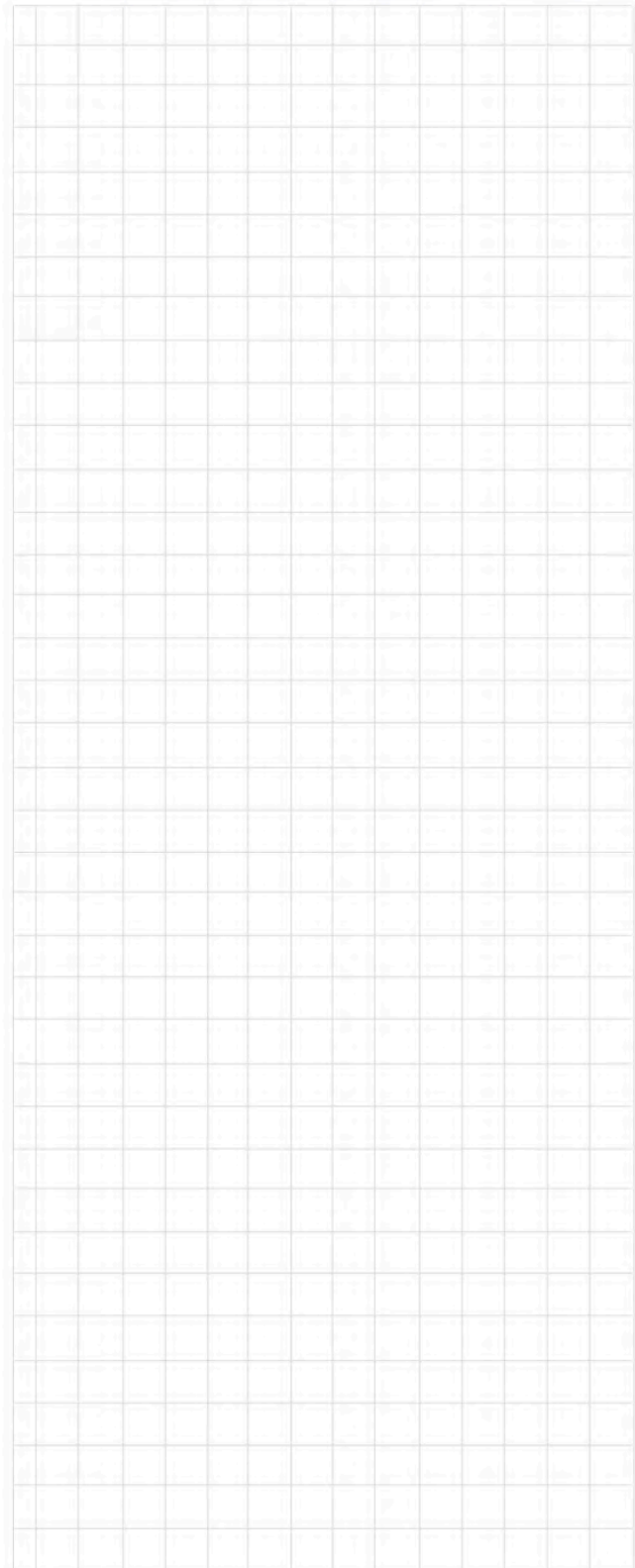



## How to Set the Ratings, con't

### Password

The Password of 0000 used in the previous Rating Level example or any other previously entered password may be changed at any time. To change the current password perform the following steps:

1. Press the SETUP Push-button on the supplied Remote Control to access the On-Screen Disc Setup Menu. Then press the Right▶ directional Push-button to select the Ratings Setup Menu Icon Tab. Refer to figure 44.

*Note: If there is a Disc playing in the MVP861 press the STOP Push-button twice before pressing the SETUP Push-button.*

2. Use the Down▼ directional Push-button to select PASSWORD followed by the pressing the SELECT Push-button twice. Refer to figures 50 and 51 on page 36.

*Notes: The title of the icon button-bar will change color from yellow (the cursor color) to green indicating the selected item.*

3. Using the Numeric Push-buttons on the Remote Control enter the current password. Refer to figure 52.
4. Again, using the NUMERIC Push-buttons on the Remote Control enter the new password to confirm it. Refer to figures 53 and 54.
5. Press the SELECT Push-button.
6. Return to the Rating Menu by pressing the Up▲ directional Push-button.
7. Next continue to the OTHER SETUP Menu. If no other changes are to be made in Setup Mode at this time, exit by pressing the Down▼ directional Push-button to select the EXIT SETUP menu choice followed by the SELECT Push-button and the MVP861 will return to normal operation.

*Note: The SETUP Push-button may be also pressed to exit the setup mode.*



Figure 50



Figure 51



Figure 52



Figure 53



Figure 54

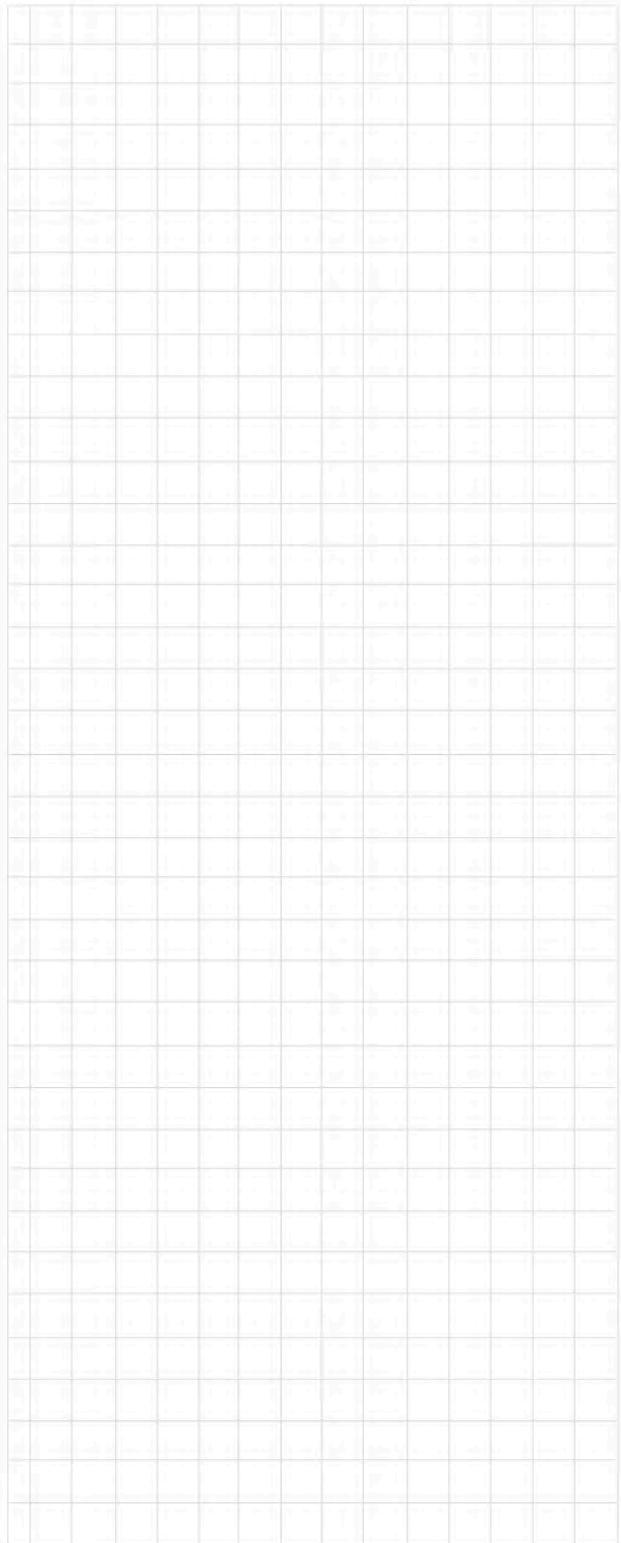



## How to Set the Other Setup

### Player Mode

Some DVD-Audio Discs offer additional different playback features such as viewing photo gallery, song lyrics and/or videos. Depending on the disc, some of features may only be available when the MVP861 Player Mode is set to the Video Mode. To change from the default setting of Audio Player Mode to Video Player Mode, perform the following steps:

1. Press the SETUP Push-button on the supplied Remote Control to access the On-Screen Disc Setup Menu. Then press the Right▶ directional Push-button to select the “etc. Setup Menu Icon Tab”. Refer to figure 55.

*Note: If there is a Disc playing in the MVP861 press the STOP Push-button twice before pressing the SETUP Push-button.*

2. Use the Down▼ directional Push-button followed by the SELECT Push-button on the Remote Control to select the PLAYER MODE Menu. Refer to figure 56.
3. To change from the default setting use the Up▲ or Down▼ directional Push-buttons to select the VIDEO followed by the SELECT Push-button.

*Note: The title of the icon button-bar will change color from yellow (the cursor color) to green indicating the selected item.*

4. Return to the Other Setup Menu by pressing the Up▲ directional Push-button.
5. Next continue to the CAPTIONS Settings. If no other changes are to be made in Setup Mode at this time, exit by pressing the Down▼ directional Push-button to select the EXIT SETUP menu choice followed by the SELECT Push-button and the MVP861 will return to normal operation.

*Note: The SETUP Push-button may be also pressed to exit the setup mode.*

### Captions

Some DVD Discs offer On-screen captions of the dialog, adding enjoyment to the movie. To activate the Caption feature perform the following steps:

1. Press the SETUP Push-button on the supplied Remote Control to access the On-Screen Disc Setup Menu. Then press the Right▶ directional Push-button to select the “etc. Setup Menu Icon Tab”. Refer to figure 55.

*Note: If there is a Disc playing in the MVP861 press the STOP Push-button twice before pressing the SETUP Push-button.*

2. Use the Down▼ directional Push-button followed by the SELECT Push-button on the Remote Control to select the CAPTIONS Menu. Refer to figure 57.



Figure 55



Figure 56



Figure 57

3. To change from the default setting of OFF use the Up▲ or Down▼ directional Push-buttons to select ON followed by the SELECT Push-button.

*Note: The title of the icon button-bar will change color from yellow (the cursor color) to green indicating the selected item.*

4. Return to the Other Setup Menu by pressing the Up▲ directional Push-button.
5. Next continue to the COMPRESSION Settings. If no other changes are to be made in Setup Mode at this time, exit by pressing the Down▼ directional Push-button to select the EXIT SETUP menu choice followed by the SELECT Push-button and the MVP861 will return to normal operation.

*Note: The SETUP Push-button may be also pressed to exit the setup mode.*



Figure 58

### Compression

The Volume Compression circuit, when switched On, suppresses loud sounds or music that might disturb neighbors or others not in the immediate area of the Home Theater. Soft levels are also raised slightly so they are still listenable at reduced overall volume levels. This works only on a Dolby Digital Sound Track with encoded data that supports the compression function. To activate the Compression feature perform the following steps:

1. Press the SETUP Push-button on the supplied Remote Control to access the On-Screen Disc Setup Menu. Then press the Right▶ directional Push-button to select the "etc. Setup Menu Icon Tab". Refer to figure 55.
2. Use the Down▼ directional Push-button followed by the SELECT Push-button on the Remote Control to select the COMPRESSION Menu. Refer to figure 58.
3. To change from the default setting of OFF use the Up▲ or Down▼ directional Push-buttons to select ON followed by the SELECT Push-button.

*Note: The title of the icon button-bar will change color from yellow (the cursor color) to green indicating the selected item.*

4. Return to the Other Setup Menu by pressing the Up▲ directional Push-button.
5. Next continue to the AUTO POWER MODE Settings. If no other changes are to be made in Setup Mode at this time, exit by pressing the Down▼ directional Push-button to select the EXIT SETUP menu choice followed by the SELECT Push-button and the MVP861 will return to normal operation.



## How to Set the Other Setup

### Auto Power Mode

The MVP861 has a feature to switch itself Off 30 minutes after a disc has stopped playing (the stop mode). To activate the Auto Power Mode feature perform the following steps:

1. Press the SETUP Push-button on the supplied Remote Control to access the On-Screen Disc Setup Menu. Then press the Right▶ directional Push-button to select the “etc. Setup Menu Icon Tab”. Refer to figure 55.

*Note: If there is a Disc playing in the MVP861 press the STOP Push-button twice before pressing the SETUP Push-button.*

2. Use the Down▼ directional Push-button followed by the SELECT Push-button on the Remote Control to select the AUTO POWER MODE Menu. Refer to figure 59.
3. To change from the default setting of OFF use the Up▲ or Down▼ directional Push-buttons to select ON followed by the SELECT Push-button.

*Note: The title of the icon button-bar will change color from yellow (the cursor color) to green indicating the selected item.*

4. Return to the Other Setup Menu by pressing the Up▲ directional Push-button.
5. Next continue to the SLIDE SHOW Settings. If no other changes are to be made in Setup Mode at this time, exit by pressing the Down▼ directional Push-button to select the EXIT SETUP menu choice followed by the SELECT Push-button and the MVP861 will return to normal operation.

*Note: The SETUP Push-button may be also pressed to exit the setup mode.*

### Slide Show

The MVP861 has a feature to view photos from a disc and the interval time between photos is adjustable from 5 to 15 seconds. To change the interval time perform the following steps:

1. Press the SETUP Push-button on the supplied Remote Control to access the On-Screen Disc Setup Menu. Then press the Right▶ directional Push-button to select the “etc. Setup Menu Icon Tab”. Refer to figure 55.

*Note: If there is a Disc playing in the MVP861 press the STOP Push-button twice before pressing the SETUP Push-button.*

2. Use the Down▼ directional Push-button followed by the SELECT Push-button on the Remote Control to select the SLIDE SHOW Menu. Refer to figure 60.



Figure 55



Figure 59



Figure 60



3. To change from the default setting of 5 seconds use the Up▲ or Down▼ directional Push-buttons to select the desired time followed by the SELECT Push-button.

*Note: The title of the icon button-bar will change color from yellow (the cursor color) to green indicating the selected item.*

4. Return to the Other Setup Menu by pressing the Up▲ directional Push-button.

5. If no other changes are to be made in Setup Mode at this time, exit by pressing the Down▼ directional Push-button to select the EXIT SETUP menu choice followed by the SELECT Push-button and the MVP861 will return to normal operation.

*Note: The SETUP Push-button may be also pressed to exit the setup mode.*

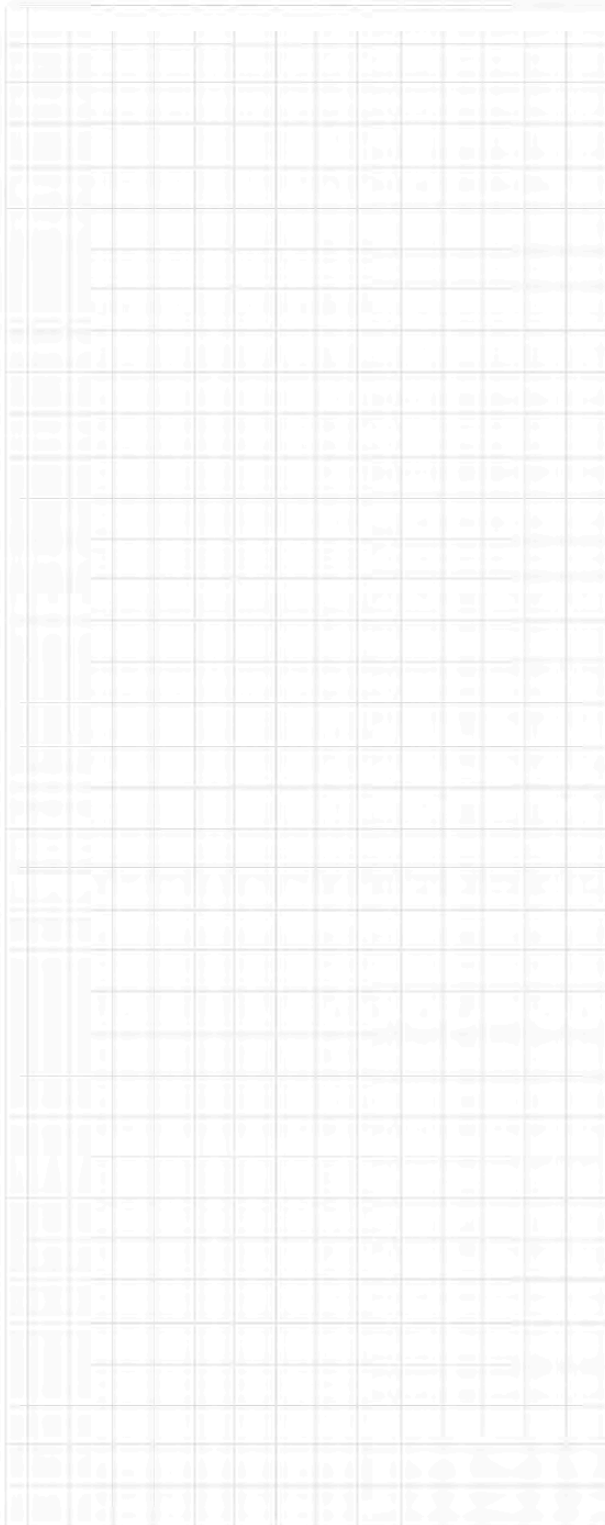



## How to Operate the MVP861

Your McIntosh MVP861 has been configured for default operating settings that will allow you to immediately enjoy superb video and high fidelity audio from a DVD, SACD or CD disc. If you wish to make changes to the default settings, a Setup feature is provided to customize the operating settings using On Screen Menus (refer to the Setup instructions in this manual). Most operations that can be performed with the Front Panel Push-buttons can also be performed with the Remote Control.

*Note: Some of the MVP861 operating functions such as Disc Languages, Video Angle or Menu Language are active only if the function is supported by data encoded on the disc.*

### Power On

The Red LED above the STANDBY/ON switch lights to indicate the MVP861 is in Standby mode. To Switch ON the MVP861, press the STANDBY/ON Push-button on the Front Panel or on the Remote Control either the PWR(Power) or POWER ON Push-button. Refer to figures 61 and 76.

*Note: When AC Power is initially applied to the MVP861 the unit will momentarily switch On and then go into the Standby Mode.*

### How to Load a DVD, SACD or CD Disc

1. Press the OPEN/CLOSE Push-button. The disc tray will slide out allowing a disc to be loaded. Refer to figures 61, 62 and 63.

*Note: When the player is in Standby Mode, the*



Figure 63

*MVP861 Power will automatically Switch-On when the OPEN/CLOSE Push-button is pressed.*

2. Press the OPEN/CLOSE Push-button and the disc tray will close. If the tray contains a DVD disc, it will start to play without pressing the PLAY Push-button. Refer to figures 61, 64, 65, 66 and 67. When a SACD or CD



Figure 62

disc is in the tray, the disc's Table of Contents (number of tracks and total playing time) will be indicated on the Front Panel Alphanumeric Display. Press the PLAY Push-button for playback of a CD.

*Note: If a CD is placed in the tray and the PLAY Push-button is pressed, instead of the OPEN/CLOSE Push-button, the tray will close and the disc will start playing the first track.*



Figure 64



Figure 65



Figure 66



Figure 67

### How to Play a DVD Disc

With a disc already loaded into the MVP861, press the PLAY Push-button on the Front Panel of the MVP861 or Remote Control. Refer to figures 61 and 70.

*Note: When a DVD Video or Audio Disc is first started, the Disc's On-Screen Menu will usually appear allowing for the choice of selections and various Audio/Video Playback Parameters.*



Figure 61

**How to Play a SACD Disc**

With a disc already loaded into the MVP861, press the PLAY▶ Push-button on the Front Panel of the MVP861 or Remote Control. The Disc will start playing the first selection of the SACD Layer; this could be either the Multichannel Tracks or 2- Channel Tracks depending on the disc contents.



Figure 68

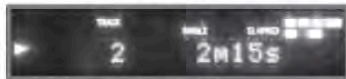

Figure 69



Figure 70



Figure 71



Figure 72



Figure 73

To change from the default Multichannel Tracks to either SACD 2-Channel or CD Tracks, press the SACD/CD Push-button on the Front Panel, until the desired track's format title appears (Multi, Stereo or CD) on the alpha-numeric display. Refer to figures 68, 69, 70, 71, 72 and 73.

*Note: SACD Discs played from now on will reflect this change, as the MVP861's AUDIO SETUP Super Audio CD Setting records the desired format as the new default.*

The Player will load the Table of Contents (Number of tracks and Total Playing Time) at this time. To start playing the desired format press the PLAY Push-button.

*Note: Changing between the formats can be accomplished at any time by performing the above procedure.*

**How to Play a CD Disc**

With a disc already loaded into the MVP861, press the PLAY▶ Push-button on the Front Panel of the MVP861 or

Remote Control. Refer to figures 73, 74 and 76.

**How to Pause a Disc**

This feature allows the temporary stopping of disc playback. Refer to figures 74, 75 and 76.

1. When playing a Disc, press the PAUSE⏸ Push-button to temporarily stop playback.

*Note: After the Pause Feature is activated, with a DVD-Video Disc in the MVP861, each additional press of the PAUSE⏸ Push-button will permit the video to advance one frame at a time.*



Figure 75

2. Press the PLAY▶ Push-button to cancel Pause and resume playing the disc.

**DVD-Video Rapid Frame Advance**

The MVP861 allows for rapid scanning of DVD Video Frames both forward or backward directions at different speeds.

1. When a disc is playing, press the PAUSE⏸ Push-button to stop playback.
2. Press the FF(Fast Forward)▶▶ or REV(Reverse)◀◀ Push-button to activate the Rapid Frame Advance.

*Note: If the FF(Fast Forward) or REV(Reverse) Push-button is pressed several times, the speed of the Frame Advance will increase. An On-Screen Icon will appear during the Rapid Frame Advance Mode indicating the advance speed.*



Figure 76



Figure 74



## How to Operate the MVP861, con't

3. To stop the Rapid Frame Advance press the PLAY ► Push-button.

### Back Track/Chapter

Advance back to the beginning of the Track/Chapter currently playing by momentarily pressing of the BACK ◀◀ Push-button on the MVP861. Repeated momentary presses of the BACK ◀◀ Push-button will allow for rapid selection of the desired previous Tracks/Chapters. Refer to figure 79.

### Next Track/Chapter

For each momentary press of the NEXT ►► Push-button the MVP861 will advance to the next Track/Chapter. Repeated momentary presses of the NEXT ►► Push-button will allow for rapid selection of the desired Track/Chapter.

### Fast Forward or Reverse

Press and release the FF (Fast Forward) ►► or REV (Reverse) ◀◀ Push-button to search back and forth rapidly through a Track/Chapter on a disc at 2 times normal speed. An On-Screen Icon will appear on the screen and the audio will be muted. If the FF (Fast Forward) ►► or REV (Reverse) ◀◀ Push-button is pressed and released several times, the speed will increase to a maximum of 64 times normal speed. To return to normal playback press the PLAY ► Push-button. Refer to figure 79.

### Stop Mode for DVD Discs

Press the STOP ■ push-button once to stop disc playback. Press PLAY ► and the disc will start playing again from the disc time where Stop was pressed. Press STOP ■ twice for a complete stop and return to the beginning of a disc. Refer to figure 79.

*Note: The video information from the disc will be muted during the Stop Mode, but will resume when the PLAY ► Push-button is pressed and playback starts. Using the Pause Push-button instead of the Stop Push-button, will retain the video on the screen for viewing. It is not advisable to keep the MVP861 in the Stop Mode (one push-button press) for any length of time as the Laser Transport is still active.*

### Stop Mode for SACD and CD Discs

Press the STOP ■ Push-button at any time to stop Disc Playback. To listen to the disc again, press the PLAY ► Push-button and playback will start from the beginning of the disc. Refer to figure 79.

### On Screen Icon Display

There are On-Screen Icons available to indicate the current audio transport operating conditions and some also provide the ability to make changes to the disc currently being played. These On-Screen Icons are accessible by pressing the DISP/TIME, AUDIO or SEARCH Push-button on the supplied Remote Control. For each of the disc types played there is at least one On-Screen Icon. If there are more than one On-Screen Icons for a given disc type, they are accessed by additional presses of the DISP/TIME Push-button. Refer to figures 77, 78 and 79.



Figure 77



Figure 78

Once the On-Screen Icon appears, changes to items such as the Track Playing, the Chapter Playing, the Group Playing, the Elapsed Time into the disc or the Audio Mode, etc. may be accomplished. The highlighted item or another item can be selected by using the DIRECTIONAL, SELECT AND NUMERIC Push-buttons on the Remote Control. After the desired changes have been made, the last press of the DISP/TIME, AUDIO or SEARCH Push-button will switch off the On-Screen Icon.

### DVD-Video Direct Chapter Selection

The MVP861 Front Panel Display indicates the Disc Chapter currently playing. Use the Remote Control NUMERIC Push-button(s) to enter the desired Chapter Number.

*Note: The desired disc Chapter may also be selected by using the On-Screen Icon and the Remote Control DIRECTIONAL, SELECT AND NUMERIC Push-buttons.*

### DVD-Audio Direct Track Selection

The MVP861 Front Panel Display indicates the Disc Track currently playing. Use the Remote Control NUMERIC Push-button(s) to enter the desired Track Number.

*Note: The desired disc Tracks may also be selected by using the On-Screen Icon and the Remote Control DIRECTIONAL, SELECT AND NUMERIC Push-buttons.*

### DVD-Audio Group Selection

To select a desired Group from a DVD-Audio Disc on the MVP861 press the DISP/TIME Push-button to access the On Screen Icon. Then press Up▲ or Down▼ directional Push-buttons to select the desired Group, then press the SELECT Push-button.

### SACD and CD Direct Track Selection

The MVP861 Front Panel Display indicates the Disc Track currently playing. Use the Remote Control NUMERIC Push-button(s) to enter the desired Track Number.

*Note: The desired disc Tracks may also be selected by using the On-Screen Icon and the Remote Control DIRECTIONAL, SELECT AND NUMERIC Push-buttons.*

### Access a Specific Time location on a DVD

The MVP861 Front Panel and the On-Screen Displays indicate the Elapsed Time of the disc when selected. A specific time on the disc may be accessed at any time by performing the following steps. Refer to figure 77.

1. Press the DISP/TIME Push-button to access the On Screen Icon.

2. Press the press the Right▶ or Left◀ directional Push-buttons to highlight the elapsed time displayed on the On-screen Icon.
3. Using the Numeric Push-buttons on the Remote Control enter the desired time, then press the SELECT Push-button.



Figure 79



## How to Operate the MVP861, con't

### How to Set and Activate Markers

This feature allows establishing up to five different starting places on a disc where playback can start, other than at the beginning of the disc.

1. Press the MRKR (Marker) Push-button and the Marker On-Screen Icon will appear. Refer to figures 80 and 87.
2. Press the SELECT Push-button to enter the first starting location. The highlighted "X" on the left side will change to a number 1.
3. The second "X" from the end of the left side will now be highlighted. Press the SELECT Push-button to enter the second starting location. Refer to figure 81.
4. Enter a third starting point if desired. Up to five Markers can be stored in memory.

*Note: If you wish to erase a MARKER, use the Left ◀ or Right ▶ directional Push-buttons to select the desired Marker and press the CLEAR push-button.*

To start playback from a desired Marker Location perform the following steps:

1. Press the MRKR (Marker) Push-button to select the Marker On-Screen Icon, if not already displayed On-Screen.
2. Using the Left ◀ or Right ▶ directional Push-buttons to select the desired Marker Starting Location, then press the SELECT Push-button.
3. Press the MRKR (Marker) Push-button to exit the Marker On-Screen Icon.

### DVD-Video Repeat

This allows repeating a DVD Chapter or the Title (the entire movie) on a continuous basis. Refer to the lower right hand corner of figures 82, 83 and figure 87.

1. Start playing the disc or the part of the disc you desire to have repeated.
2. Press the RPT (Repeat) Push-button once to activate the Chapter Repeat (1); press the RPT Push-button twice to activate the Title Repeat (All). Refer to the On-Screen Text Message.
3. To cancel the previously selected Repeat Mode, press the RPT (Repeat) Push-button until the On-Screen Text Message indicates "REPEAT Off" or the word "REPEAT" in the lower right hand corner of the Front Panel Alphanumeric Display is extinguished.

### DVD-Audio Repeat

This allows repeating a DVD Track or the Group (a selection of tracks) on a continuous basis. Refer to the lower right hand corner of figures 82, 83 and figure 87.

1. Start playing the disc or the part of the disc you desire to have repeated.



Figure 80



Figure 81



Figure 82



Figure 83

2. Press the RPT (Repeat) Push-button once to activate the Track Repeat (1); press the RPT Push-button twice to activate the Group Repeat (All). Refer to the On-Screen Text Message.
3. To cancel the previously selected Repeat Mode, press the RPT (Repeat) Push-button until the On-Screen Text Message indicates "REPEAT Off" or the word "REPEAT" in the lower right hand corner of the Front Panel Alphanumeric Display is extinguished.

### SACD or CD Repeat

This allows repeating a SACD/CD Track or the Disc on a continuous basis. Refer to the lower right hand corner of figures 82, 83 and figure 87.

1. Start playing the disc or the part of the disc you desire to have repeated.
2. Press the RPT (Repeat) Push-button once to activate the Track Repeat (1); press the RPT Push-button twice to activate the Disc Repeat (All). Refer to the On-Screen Text.
3. To cancel the previously selected Repeat Mode, press the RPT (Repeat) Push-button until the On-Screen Text message indicates "REPEAT Off" or the word "REPEAT" in the lower right hand corner of the Front Panel Alphanumeric Display is extinguished.

### Disc A-B Repeat

This feature allows the repeating of a specific disc segment on a continuous basis. Refer to the lower right hand corner of figures 84, 85 and figure 87.

1. Start playing the part of the disc you desire to have repeated.
2. Press the A-B Push-button once to enter the A (starting point) and press the same push-button a second time B (ending point). Refer to the On-Screen Text.
3. To cancel A-B REPEAT function press the A-B Push-button once again. The On-Screen Text message indicates "A to B CANCELED" or the word "REPEAT A-B" in the lower right hand corner of the Front Panel Alphanumeric Display is extinguished.



Figure 84



Figure 85

### Random Playback

This feature allows for listening to Tracks of a SACD or CD Disc in a Random Order. It also allows for the playback of Tracks in a Group on a DVD-Audio Disc in random order. Refer to figure 87.

*Note: The MVP861 must be in STOP Mode with the Disc Loaded (Table of Contents) read first before the Random Playback Mode Feature can be activated.*

1. After the Table of Contents has been read with the transport in the full stop mode (press the Stop Push-button Twice), press the Random Push-button. Refer to the lower right hand corner of figure 86.
2. Press the PLAY Push-button to start Random Playback, after all the tracks have been played the MVP861 will stop.



Figure 86

*Note: To provide continuous playback of the disc, the Repeat All Mode may be combined with the Random Playback mode.*

3. To cancel the Random Playback function press the Random Push-button.



Figure 87



## How to Operate the MVP861, con't

### Audio Disc Program Playback Mode

This feature allows for the playback of pre-selected Groups and/or Tracks of a DVD-Audio, SACD and CD Discs in the desired order. In the example below, a DVD-Audio Disc is programmed to play Group 2/Track 5 followed by Group 1/Track 2.

- Notes:*
1. The MVP861 must be in full STOP Mode (two presses of the STOP Push-button) with the Disc TOC (Table of Contents) read before the Program Playback Mode Feature can be activated.
  2. When programming Hybrid SACD Discs, first choose the format (Multichannel, Stereo or CD) so the correct TOC can be read as some discs have different selections.
  3. If a DVD-Audio disc has both formats (DVD-Audio and DVD-Music Video), only the DVD-Audio Groups/Tracks are programmable.

1. Press the PGM (Program) Push-button to access the On-Screen Program Mode. Refer to figures 88, 89 and 96.

*Note:* It is possible to enter a Program using



Figure 89

just the Front Panel Alphanumeric Display, however it is easier to use the On-Screen Display as all of the desired Groups/Tracks are displayed at one time.

2. Enter the first Program Step, the desired selection and Group Number using the Numeric Push-buttons. Refer to figures 90, 91 and 96.



Figure 91

*Note:* There are only Track numbers when Programming SACD and CD Discs. The On-Screen Display along with the Front Panel Display will not indicate space for entering Group Numbers. The MVP861 automatically stores into memory each of the program steps as they are entered.

3. In a similar manner, enter the remaining desired Groups and Tracks. Refer to figures 92 and 93.

*Note:* The Left◀ or Right▶ directional Push-buttons may be used for a given Program Step, to go between the Group Number and Track Number. The CLEAR Push-button may be used to delete a selected Program Step.



Figure 88



Figure 90



Figure 92





Figure 93

4. To start playback of the just entered program press the PLAY ► Push-button. The Repeat Mode can be activated to provide continuous playback of the Programmed Selections. Refer to figure 94.

*Note: To momentarily stop playback press either the Pause || Push-button or the STOP ■ Push-button once. To resume Program Playback press the PLAY ► Push-button.*



Figure 94

5. To cancel the Program Playback Mode press the STOP ■ Push-button twice followed by pressing the PGM (Program) Push-button.

### Reset of Microprocessors

In the unlikely event the controls of the MVP861 stop functioning, the microprocessors can be reset by performing the following:

1. Press and hold in the STANDBY/ON Push-button for approximately five seconds. Refer to figure 95.

*Note: This can be performed with the MVP861 On or in the Standby Mode.*



Figure 95

2. When the STANDBY/ON LED is no longer illuminated release the STANDBY/ON Push-button.
3. The MVP861 will automatically switch On and normal operation will resume.



Figure 96



## How to Operate the MVP861, con't

### MP3 Audio CD, JPEG Photo CDs and Video CD Playback

The MVP861 has the ability of playing back special types of disc formats that are created primarily on a computer. The ability to successfully playback these discs on the MVP861 Player is depend upon using the correct hardware and software. Please refer to maker of the computer and software publisher to insure proper results.

The MP3 Audio CD Format allows the placing of more tracks on a CD Disc by using the technique of lossy compression applied to the original audio information. The MP3 Track after compression is applied, results in lower audio quality than the original recording.

The JPEG Photo File Format is used by a majority of Digital Photo Cameras on the market and the Photos are easily viewed on a variety of consumer products. Some of the Kodak<sup>1</sup> Picture CDs and Fujifilm<sup>2</sup> Fujicolor<sup>2</sup> CDs many also playback on the MVP861.

The Video CDs allow for the playback of "Live Video" copied from devices such as Camcorders and some Digital Cameras.

### MP3 Audio Playback

The MVP861 will display the Folder Structure and Tracks from a CD Disc with MP3 format to make the song selection process easier. To play a MP3 disc perform the following steps:

1. Load a MP3 Disc into the MVP861, about 5 to 20 seconds later a Disc Information On-screen Icon will appear on the Monitor/TV indicating the Folder/Tracks Organization of the Disc. Refer to figures 97 and 100.
2. Use the Right▶ or Left◀ / Up▲ or Down▼ directional Push-buttons to highlight the desired Folder or Track followed by the pressing the SELECT Push-button. If a Folder was selected, use the directional push-buttons to select the desired Track within the folder, then push the SELECT Push-button. The selected Track will now start playing.

*Notes: The Column on the left side of the Disc Information On-screen Icon indicates any folders on the Disc. The right side column indicates Tracks located in the open Folder. The basic transport functions such as Next, Back, Fast-Forward, Reverse, Stop, Pause and Play continue to function as normal. The Next and Back Push-buttons will select Tracks within the current folder. To play Tracks in other Folders use the direction push-buttons to select the desired folder first.*

<sup>1</sup>"Kodak" is a trademark of Eastman Kodak Company.

<sup>2</sup>"Fujifilm" and "Fujicolor" are trademarks of the Fuji Company.

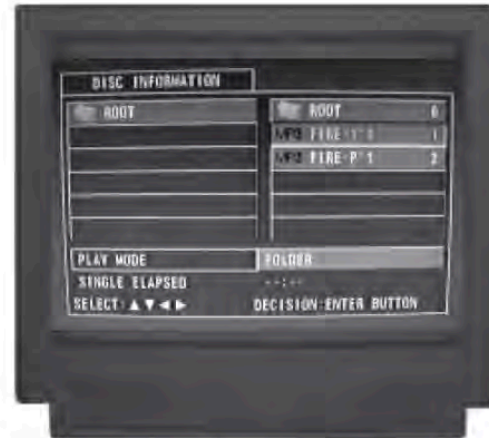

Figure 97

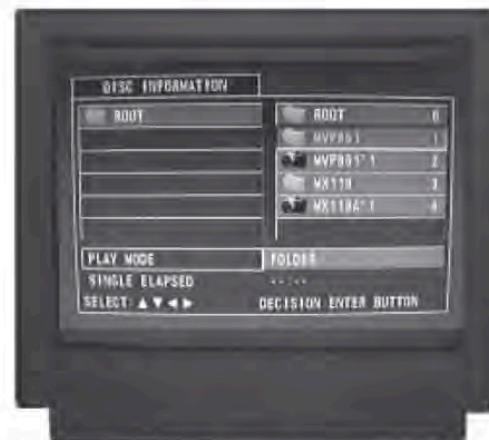

Figure 98



Figure 99

### JPEG Photo CDs

The MVP861 will display the Folder Structure and Photos from a CD Disc with JPEG file format. To view a JPEG Photo disc perform the following steps:

1. Load a JPEG Disc into the MVP861, about 5 to 20 seconds later a Disc Information On-screen Icon will appear on the Monitor/TV indicating the Folder/Photo Organization of the Disc. Refer to figures 98, 99 and 100.
2. Use the Right▶ or Left◀ / Up▲ or Down▼ directional Push-buttons to highlight the desired Folder or Photo followed by the pressing the SELECT Push-button. If a Folder was selected, use the directional push-buttons to select the desired Photo within the folder, then push the SELECT Push-button. The selected Photo will appear now.

*Notes: The column on the left side of the Disc Information On-screen Icon indicates any folders on the Disc. The right side column indicates Photos located in the open Folder. The basic transport functions such as Next, Back, Stop, Pause and Play continue to function as normal. The Next and Back Push-buttons will select Photos within the current folder. To view Photos in other Folders use the direction push-buttons to select the desired folder first.*

### Video CDs

To start playback of the Video CD Disc perform the following steps:

1. Load a Video CD Disc into the MVP861, about 5 to 20 seconds later a Disc Menu On-screen Icon will appear on the Monitor/TV indicating the available choices for playback. Refer to figure 100.
2. Use the Right▶ or Left◀ / Up▲ or Down▼ directional Push-buttons to highlight the desired Video followed by the pressing the SELECT Push-button. The selected Video will start playing.

*Notes: The basic transport functions such as Fast-Forward, Reverse, Stop, Pause and Play continue to function as normal.*



Figure 100



## How to Operate the MVP861, con't

### Video Settings

A MVP861 option allows the adjustment of various video parameters, not unlike what can be adjusted on a TV/Monitor. These custom adjustments can be stored into one of five memory locations. To enter custom settings perform the following steps:

1. Press the PICADJ (Picture Adjustment) Push-button to access the On Screen Icon. Refer to figure 101.  
*Note: The STD (Standard) is the default setting for the various picture adjustments.*
2. Press the Right▶ directional Push-button to select the "M1" Memory Location. Refer to figure 102.
3. Press the SELECT Push-button to access the "M1" Picture Adjustment Settings. Refer to figure 103.
4. Press the Down▼ directional Push-button to activate the Picture Contrast Setting; use the Up▲ or Down▼ directional Push-buttons to adjust the Contrast from a setting of -6 to +6. Refer to figures 104 thru 107 for steps 4 thru 10.
5. Press the Right▶ directional Push-button to select the Picture Brightness Setting.
6. Use the Up▲ or Down▼ directional Push-buttons to adjust the Brightness from a setting of 0 to +12.
7. Press the Right▶ directional Push-button to select the Picture Sharpness Setting.
8. Use the Up▲ or Down▼ directional Push-buttons to adjust the Sharpness from a setting of -6 to +6.
9. Press the Right▶ directional Push-button to select the Picture Hue (Tint) Setting.
10. Use the Up▲ or Down▼ directional Push-buttons to adjust the Hue from a setting of -6 to +6.  
*Note: The Hue Setting is active for the Composite Video and S-Video Outputs only.*
11. Press the SELECT Push-button followed by pressing the Right▶ directional Push-button to activate the Picture GAMMA Setting. Refer to figures 108 and 109.

*Note: The Gamma settings are for making fine adjustments to the Picture's dynamic range from black (16) to white (235). Each of the Steps on the On-screen Icon display are adjustable, with the Highlighted Number acting as a reference.*

12. Press the Down▼ directional Push-button followed by the Right▶ or Left◀ directional Push-button to select a point (Step) on the Gamma curve.
13. Use the Up▲ or Down▼ directional Push-buttons to make fine adjustments. When the desired adjustments are complete press the SELECT Pushbutton to exit the Gamma settings and press the PICADJ Push-button to exit the Picture Adjustments.

*Note: The Picture Setting changes are stored in memory until new values are entered.*



Figure 101



Figure 102



Figure 103



Figure 104



Figure 107



Figure 105



Figure 108



Figure 106



Figure 109



## Audio Specifications

---

### Number of Channels

2 and 5.1

### Output level

2.0Vrms Balanced (2 channel Output)  
2.0Vrms Unbalanced (2 channel Output and 5.1 Channels)

### Output Impedance

600 ohms Balanced (2 channel Output)  
600 ohms Unbalanced (2 channel Output and 5.1 Channels)

### Audio Frequency Response (DVD-Video)

4Hz to 22,000Hz (48kHz Sampling, Linear Audio)  
4Hz to 44,000Hz (96kHz Sampling, Linear Audio)

### Audio Frequency Response (DVD-Audio)

4Hz to 88,000Hz (192kHz Sampling)

### SACD Frequency Response

4Hz to 100,000Hz

### CD Frequency Response

4Hz to 20,000Hz

### Signal to Noise Ratio

115dB

### Dynamic Range

Better than 110dB

### Harmonic Distortion

0.002%

### Channel Separation

Better than 110dB (1,000Hz)

## Video Specifications

---

### Signal System

NTSC/PAL Region Code 1

### Component Video Output Level

Y Output Level 1.0Vp-p (75 OHM)  
P<sub>B</sub> Output Level 0.648Vp-p (75 OHM)  
P<sub>R</sub> Output Level 0.7Vp-p (75 OHM)

### S-Video Y Output Level

1Vp-p (75 OHM)

### S-Video C Output Level

0.286Vp-p (75 OHM) (NTSC)

### Video Output Level

1Vp-p (75 OHM)

## General Specifications

---

### Digital Output

Optical: -15dbm to -21dbm  
Coaxial: 0.5V p-p/75 ohm

### Digital Signal Format

Sampling Frequencies: 44.1kHz, 48.0kHz and 96.0kHz

### Transport

Laser Beam Wavelength: 630nm/810nm  
Laser Power: CLASS I

### Power Requirements

100 Volts, 50/60Hz at 35 watts  
110 Volts, 50/60Hz at 35 watts  
120 Volts, 50/60Hz at 35 watts  
220 Volts, 50/60Hz at 35 watts  
230 Volts, 50/60Hz at 35 watts  
240 Volts, 50/60Hz at 35 watts

*Note: Refer to the rear panel of the MVP861 for the correct voltage.*

### Overall Dimensions

Width is 17-1/2 inches (44.45cm)  
Height is 5-3/8 inches (13.69cm)  
Depth is 13-1/8 inches (33.38cm)

*Note: When the Disc Tray is opened, the panel clearance required in front of mounting panel is 6-3/4 inches (17.2cm).*

### Weight

21.5 pounds (9.8Kg) net, 35.5 pounds (16.1Kg) in shipping carton

## Packing Instructions

### Packing Instructions

In the event it is necessary to repack the equipment for shipment, the equipment must be packed exactly as shown below. It is very important that the four plastic feet are attached to the bottom of the equipment. This will ensure the proper equipment location on the bottom pad. Failure to do this will result in shipping damage.

Use the original shipping carton and interior parts only if they are all in good serviceable condition. If a shipping carton or any of the interior part(s) are needed, please call or write Customer Service Repair Department of McIntosh Laboratory. Please see the Parts List for the correct part numbers.

Quantity	Part Number	Description
1	034075	Shipping carton only
4	033837	Foam end cap
1	034076	Inside carton only
1	033726	Top pad
1	034036	Bottom pad
1	034077	Inner carton pad
4	017218	Plastic foot
4	100159	#10-32 x 3/4" screw
4	104083	#10 x 7/16" Flat washer

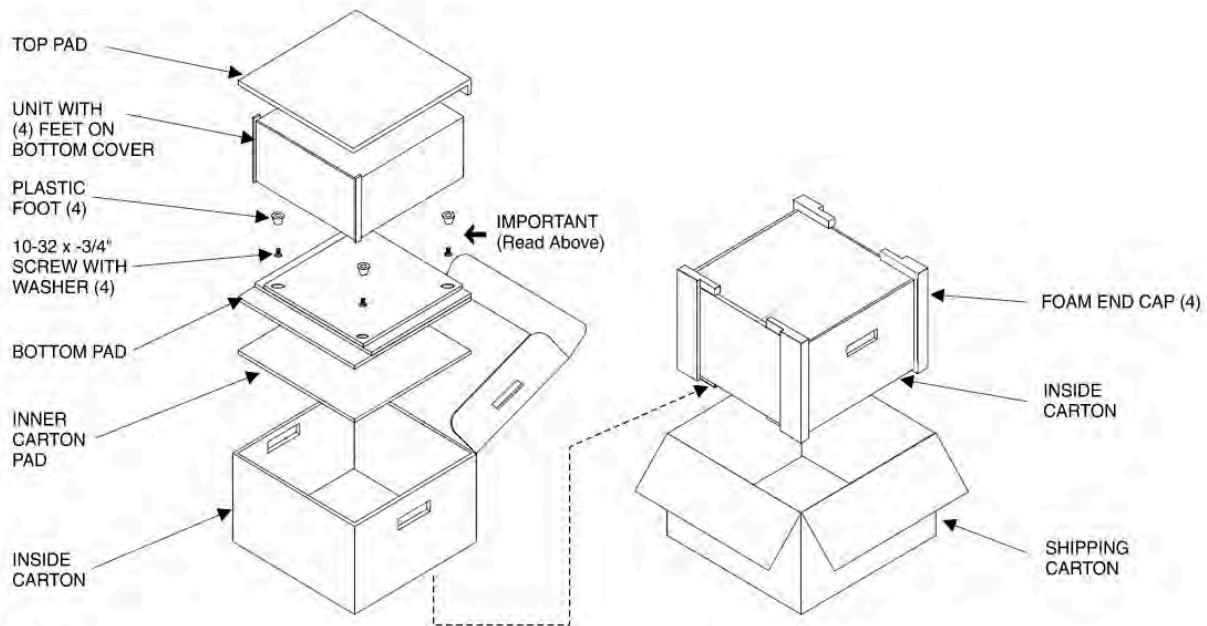



McIntosh Laboratory, Inc.  
2 Chambers Street  
Binghamton, NY 13903

The continuous improvement of its products is the policy of McIntosh Laboratory Incorporated who reserve the right to improve design without notice.

Printed in the U.S.A.

McIntosh Part No. 04092200