



## Tube Integrated Amplifier



## MA2275 Owner's Manual

The lightning flash with arrowhead, within an equilateral triangle, is intended to alert the user to the presence of uninsulated "dangerous voltage" within the product's enclosure that may be of sufficient magnitude to constitute a risk of electric shock to persons.



AVIS RISQUE DE CHOC ELECTRIQUE - NE PAS OUVRIR.

The exclamation point within an equilateral triangle is intended to alert the user to the presence of important operating and maintenance (servicing) instructions in the literature accompanying the appliance.

**WARNING - TO REDUCE RISK OF FIRE OR ELECTRICAL SHOCK, DO NOT EXPOSE THIS EQUIPMENT TO RAIN OR MOISTURE.**

**NO USER-SERVICEABLE PARTS INSIDE. REFER SERVICING TO QUALIFIED PERSONNEL.**

To prevent the risk of electric shock, do not remove cover or back. No user serviceable parts inside.

## IMPORTANT SAFETY INSTRUCTIONS!

**PLEASE READ THEM BEFORE OPERATING THIS EQUIPMENT.**

1. Read these instructions.
2. Keep these instructions.
3. Heed all warnings.
4. Follow all instructions.
5. Do not use this apparatus near water.
6. Clean only with a dry cloth.
7. Do not block any ventilation openings. Install in accordance with the manufacturer's instructions.
8. Do not install near any heat sources such as radiators, heat registers, stoves, or other apparatus (including amplifiers) that produce heat.
9. Do not defeat the safety purpose of the polarized or grounding-type plug. A polarized plug has two blades with one wider than the other. A grounding type plug has two blades and a third grounding prong. The wide blade or the third prong are provided for your safety. If the provided plug does not fit into your outlet, consult an electrician for replacement of the obsolete outlet.
10. Protect the power cord from being walked on or pinched particularly at plugs, convenience receptacles, and the point where they exit from the apparatus.
11. Only use attachments/accessories specified by the manufacturer.
12. Use only with the cart, stand, tripod, bracket, or table specified by the manufacturer, or sold with the apparatus. When a cart is used, use caution when moving the cart/apparatus combination to avoid injury from tip-over. 
13. Unplug this apparatus during lightning storms or when unused for long periods of time.
14. Refer all servicing to qualified service personnel. Servicing is required when the apparatus has been damaged in any way, such as power-supply cord or plug is damaged, liquid has been spilled or objects have fallen into the apparatus, the apparatus has been exposed to rain or moisture, does not operate normally, or has been dropped.
15. Do not expose this equipment to dripping or splashing and ensure that no objects filled with liquids, such as vases, are placed on the equipment.
16. To completely disconnect this equipment from the a.c. mains, disconnect the power supply cord plug from the a.c. receptacle.
17. The mains plug of the power supply cord shall remain readily operable.

---

## Thank You

Your decision to own this McIntosh MA2275 Tube Integrated Amplifier ranks you at the very top among discriminating music listeners. You now have “The Best.” The McIntosh dedication to “Quality,” is assurance that you will receive many years of musical enjoyment from this unit.

Please take a short time to read the information in this manual. We want you to be as familiar as possible with all the features and functions of your new McIntosh.

---

## Please Take A Moment

The serial number, purchase date and McIntosh Dealer name are important to you for possible insurance claim or future service. The spaces below have been provided for you to record that information:

**Serial Number:** \_\_\_\_\_

**Purchase Date:** \_\_\_\_\_

**Dealer Name:** \_\_\_\_\_

---

## Technical Assistance

If at any time you have questions about your McIntosh product, contact your McIntosh Dealer who is familiar with your McIntosh equipment and any other brands that may be part of your system. If you or your Dealer wish additional help concerning a suspected problem, you can receive technical assistance for all McIntosh products at:

McIntosh Laboratory, Inc.  
2 Chambers Street  
Binghamton, New York 13903  
Phone: 607-723-1545  
Fax: 607-723-3636

---

## Customer Service

If it is determined that your McIntosh product is in need of repair, you can return it to your Dealer. You can also return it to the McIntosh Laboratory Service Department. For assistance on factory repair return procedure, contact the McIntosh Service Department at:

McIntosh Laboratory, Inc.  
2 Chambers Street  
Binghamton, New York 13903  
Phone: 607-723-3515  
Fax: 607-723-1917

---

## Table of Contents

Safety Instructions .....	2
Thank You and Please Take a Moment.....	3
Technical Assistance and Customer Service .....	3
Table of Contents and Important Information .....	3
Connector Information .....	4
Introduction .....	4
Performance Features .....	4
Dimensions .....	5
Installation of Tubes, Equipment Location and Ventilation .....	6
Installation in a Custom Cabinet .....	8
Top Panel Connections and Tube Locations .....	9
Rear Panel Connections .....	10
How to Connect Loudspeakers .....	11
How to Connect Audio Components .....	12
How to Connect for a Second Room .....	13
Front Panel Controls, Displays, Push-Buttons and Switch .....	14
How to Operate .....	15
Remote Control Push-Buttons .....	18
How to Operate by Remote Control .....	19
Specifications .....	22
Packing Instruction .....	23

---

## Important Information

- 1. Caution: To prevent electrical shock make sure the AC POWER CORD IS NOT CONNECTED TO THE MA2275. Also do not touch the Vacuum Tube Connection Pins when inserting or removing them, as there may be hazardous voltages present at the Tube Socket Pins even after the MA2275 has been switched Off for a period of time.**
2. When Vacuum Tubes are installed or removed, reattach the Tube Cover with the Original Tube Cover Screws.
3. If the MA2275 has been On, please allow the Hot Vacuum Tubes to cool first before removing them.
4. The following Connecting Cable is available from the McIntosh Parts Department:  
**Data and Power Control Cable Part No. 170-202**  
Six foot, 2 conductor shielded, with two 1/8 inch stereo mini phone plugs.
5. For additional connection information, refer to the owner's manual(s) for any component(s) connected to the MA2275.
6. It is very important that loudspeaker cables of adequate size be used, so that there will be minimum power loss. The size is specified in Gauge Numbers or AWG (American Wire Gauge). The smaller the Gauge number, the larger the wire size. Connection Terminals will accept up to a 8 AWG wire size:  
If your loudspeaker cables are 50 feet (38.1m) or less, use at least 14 Gauge.  
If your loudspeaker cables are 100 feet (76.2m) or less, use at least 12 Gauge.

### Connector Information

#### XLR Connectors

Below is the Pin configuration for the XLR Balanced Input Connectors on the MA2275. Refer to the diagram for connection:

- PIN 1: Shield/Ground
- PIN 2: + Input
- PIN 3: - Input

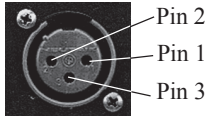

#### Power Control Connectors

The MA2275's Power Control Outputs provide a 5 volt signal. Use a 1/8 inch stereo mini phone plug to connect to the Power Control Input on other McIntosh Components.

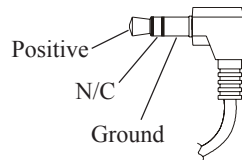

#### Data Port Connectors

The MA2275's Data Port Output provides Remote Control Signals. Use a 1/8 inch stereo mini phone plug to connect to the Data Port Inputs on McIntosh Source Units.

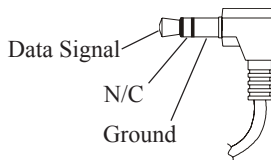

### Introduction

Now you can take advantage of traditional McIntosh standards of excellence in the MA2275 Tube Integrated Amplifier. The versatile Preamplifier together with two 75 watt Power Amplifier Channels provide all the electronics necessary to drive any high quality Loudspeaker System. The MA2275 reproduction is sonically transparent and absolutely accurate. The McIntosh Sound is "The Sound of the Music Itself."

### Performance Features

#### ● Power Output

The MA2275 has two separate power amplifier channels, each capable of 75 watts into 2, 4 or 8 ohm Loudspeakers.

#### ● Bifilar Wound Transformers and Output Circuit

The Power Output Circuitry utilizes the famous McIntosh Patented Unity Coupled Circuit with a Bifilar Wound Output Transformer for low distortion, extended frequency response and cool operating output tubes.

#### ● Electronic Input Switching

Digital Logic integrated circuits drive Electromagnetic Switches on all inputs and operating functions for reliable, noiseless, distortion free switching.

#### ● Balanced and Unbalanced Inputs

The MA2275 has five Inputs for high level program sources and one Phono Input for a Moving Magnet Cartridge.

#### ● Tone Control Bypass

The Bass and Treble Control Circuit Elements can be removed from the Signal Path.

#### ● Low Distortion

Distortion levels of all types are less than 0.5%. Music is amplified with total transparency and accuracy.

#### ● Remote Control Operation

A Remote Control is included that will allow control of major front panel controls and switches. There are provisions for connecting External Keypad and/or Sensors, which allows for enjoyment of your McIntosh System from other rooms in your home.

#### ● Illuminated Power Meters

Peak responding Power Output Meters will indicate either continuously or in a peak hold mode for each channel. There is also a Meter Illumination Off Mode if desired.

#### ● Gold Plated Connectors and Tube Socket Contacts

Gold Plated Input Jacks and Output Binding Posts provide trouble free connections. Ceramic tube sockets with gold plated contacts provide protection from atmospheric contamination. Output Tube Sockets include Air-Pipe cooling at their bases.

#### ● Fiber Optic Solid State Front Panel Illumination

The even Illumination of the Glass Front Panel is accomplished by the combination of custom designed Fiber Optic Light Diffusers and extra long life Light Emitting Diodes (LEDs).

#### ● Super Mirror Chassis Finish

The Stainless Steel Chassis with Super Mirror Finish ensures the pristine beauty of the MA2275 will be retained for many years.

**Dimensions**

The following dimensions can assist in determining the best location for your MA2275. There is additional information on page 8 pertaining to installing the MA2275 into cabinets.

**Front View of the MA2275**

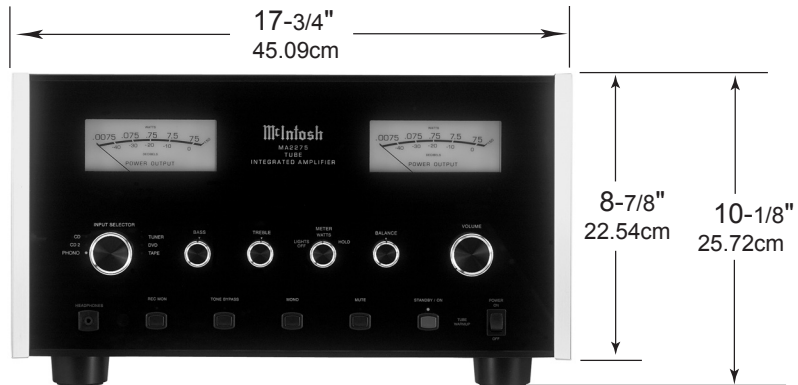

**Rear View of the MA2275**

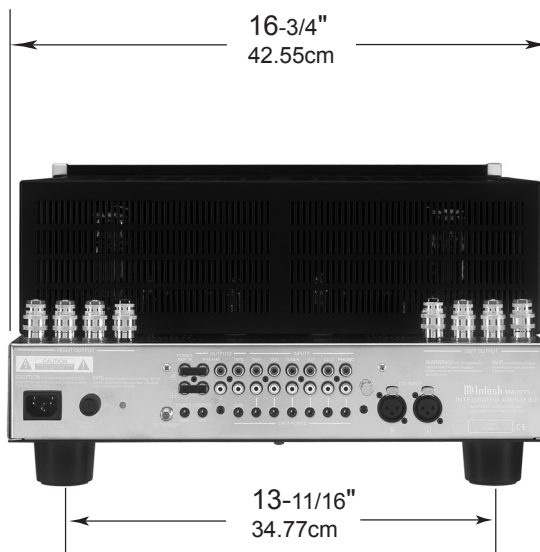

**Side View of the MA2275**

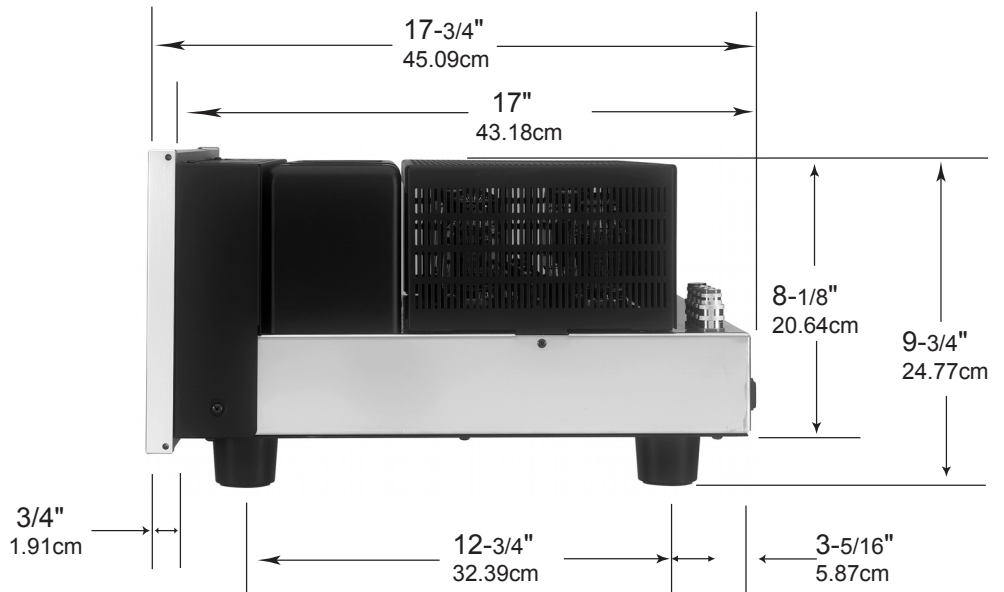

## Installation of Tubes and Tube Cover

**Caution:** To prevent electrical shock make sure the AC POWER CORD IS NOT CONNECTED TO THE MA2275. Also do not touch the Vacuum Tube Connection Pins when inserting or removing them, as there may be hazardous voltages present at the Tube Socket Pins even after the MA2275 has been switched Off for a period of time.

Your MA2275 has gone through an extensive series of performance tests during the manufacturing process. The MA2275 is supplied with the actual Tubes that were used to test and confirm the performance of this integrated amplifier. To protect the Vacuum Tubes from possible shipping damage, they are packed in five layers of foam, placed into the Tube Cover and secured to the MA2275 Chassis.

*Note:* Gloves or a soft cloth will prevent “fingerprinting” of the Tubes during their installation.

1. Orient the MA2275 so the right Side Panel is facing you. Refer to figure 1.
2. Using an appropriate screwdriver, remove the Tube Cover Fastening Screw.
3. In a similar manner, remove the Tube Cover Fastening Screw from the left side of the integrated amplifier.
4. Remove the tube cover from the MA2275 Chassis.
5. Orient the Tube Cover to the wide opening along one side of its longer dimension. Refer to figure 2.
6. Remove the first layer of foam to expose the Tubes. Refer to figure 3.
7. Carefully remove the Tubes from the foam and temporarily place them in a safe location.
8. Remove the remaining foam from the Tube Cover and retain all five pieces for possible future use.

The MA2275 Chassis has nomenclature screened on it to specify the location in the circuit and Tube Type for each channel. Refer to figure 4.

*Note:* It is extremely important to insert the Tubes in the correct location.

### Power Output Tubes:

1. Orient the Chassis so the Front Panel of the Amplifier is facing you.
2. Locate a KT88 or 6550 Power Output Tube.
3. On the top left side of the amplifier, locate the Tube Socket that has the nomenclature V3L KT88/6550 next to it on the chassis.
4. Orient the Tube so the key on the base of the Tube is aligned with the corresponding key on the Tube Socket.
5. Carefully insert the Tube into the socket until the base of the Tube is fully seated in the Tube Socket.

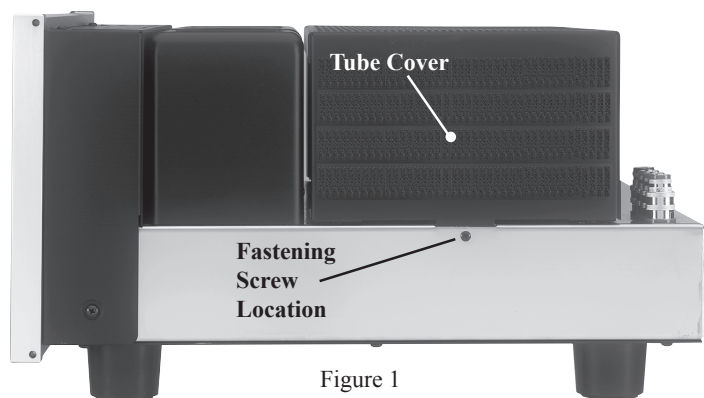

Figure 1



Figure 2

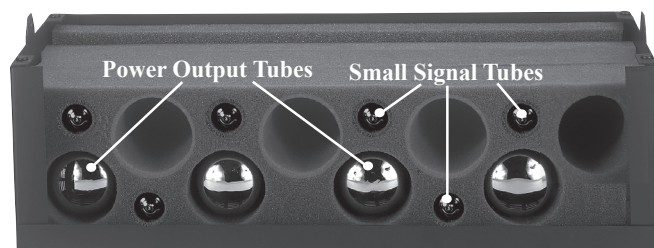

Figure 3



Figure 4

- Repeat the above steps for the remaining 3 Power Output Tubes.

There are two different types of Small Signal Tubes (12AX7A and 12AT7) used in each channel. Tube type can be found on the outside of the Tube. The MA2275 will not function if they are inserted into the wrong socket.

### Small Signal Tubes:

- Locate a 12AX7A Tube.
- On the top center area of the amplifier, locate the Tube Socket that has the nomenclature V4 12AX7A next to it on the chassis. Refer to figure 4.
- Orient the Tube so the area where no pins are located on the base of the Tube is aligned with the corresponding area on the Tube Socket.
- Carefully insert the Tube into the socket until the base of the Tube is fully seated in the Tube Socket.
- Repeat the above steps for the remaining three 12AX7A Tubes. Refer to figure 5.
- Locate a 12AT7 Tube.
- On the right side of the amplifier, locate the Tube Socket that has the nomenclature V1R 12AT7 next to it on the chassis. Refer to figure 4.
- Insert the Tube, following the same procedure as in steps 3 and 4.
- Repeat steps 6-9 for the remaining 12AT7 Tube. Refer to figure 5.

**Caution:** To prevent electrical shock make sure the MA2275 Tube Cover is installed before connecting the AC Power Cord.

Before operating the MA2275, locate the previously removed Tube Cover and perform the following steps:

### Installing the Tube Cover:

- The Tube Cover has a wide opening along one side of its longer dimension. Orient this wide opening so it is facing towards you.
- Carefully place the Tube Cover onto the MA2275. Refer to figure 6.
- Using an appropriate screwdriver secure the Tube Cover to the chassis using the previously installed screws.

## Location and Ventilation

Adequate ventilation extends the trouble free life of the MA2275. The suggested minimum space for operating the MA2275 is 24 inches (60.96cm) in width, 20 inches (50.8cm) depth, and 22.5 inches (57.15cm) in height. Always allow air to flow through the ventilation holes on the bottom of the amplifier and a means for the warm air to escape at the top, refer to figure 7. For installation of the MA2275 into a cabinet, refer to the next page.

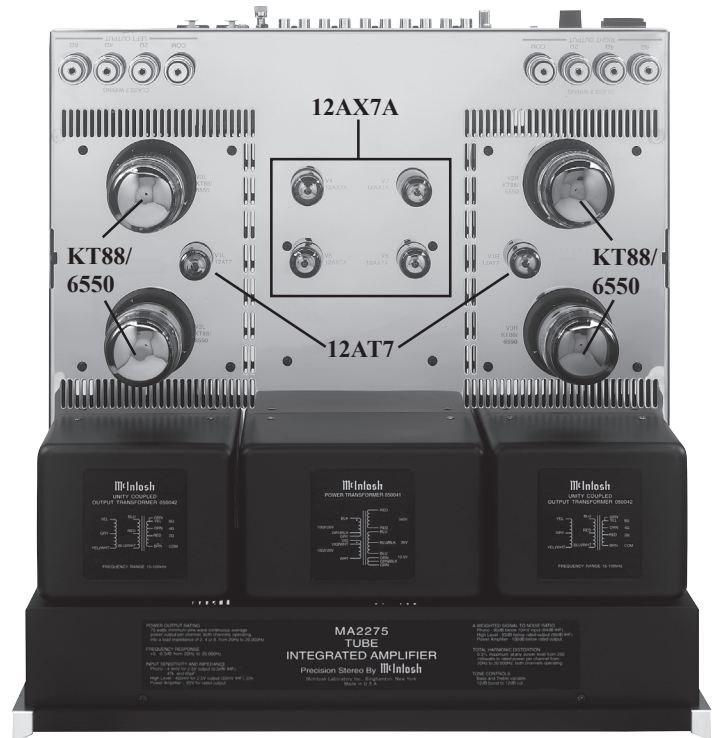

Figure 5

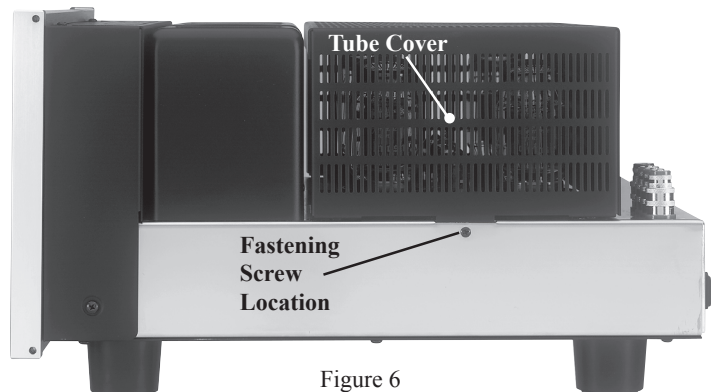

Figure 6

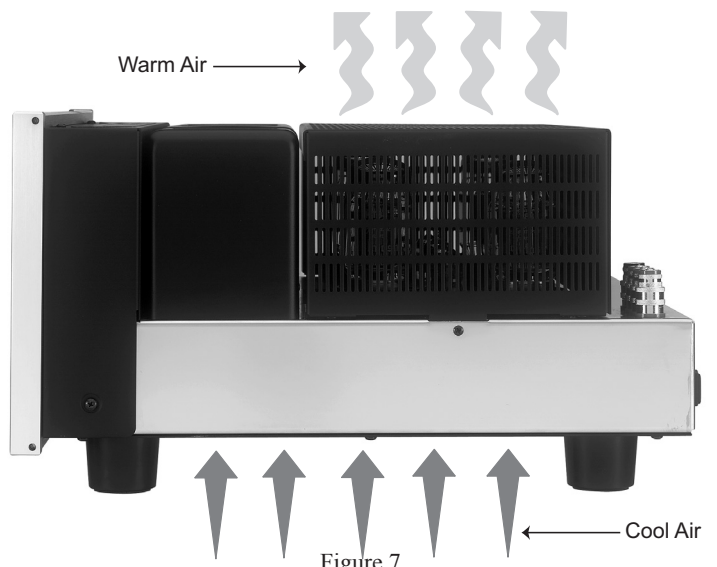

Figure 7

The MA2275 can be placed upright on a table or shelf, standing on its four feet. It also can be custom installed in a piece of furniture or cabinet of your choice. The four feet may be removed from the bottom of the MA2275 when it is custom installed as outlined below. The four feet together with the mounting screws should be retained for possible future use if the MA2275 is removed from the custom installation and used free standing. Install the four supplied chassis spacers into the threaded openings on the bottom located next to the just removed four feet. The required panel cutout, ventilation cutout and unit dimensions are shown.

Always provide adequate ventilation for your MA2275. Cool operation ensures the longest possible operating life for any electronic instrument. Do not install the MA2275 directly above a heat generating component such as a high powered amplifier. If the MA2275 is installed in a cabinet, a quiet running ventilation fan can be a definite asset in maintaining the coolest possible operating temperature.

A custom cabinet installation should provide the following minimum spacing dimensions for cool operation. Allow at least 12 inches (30.48cm) above the top, 2 inches (5.08cm) below the bottom and 3 inches (7.62cm) on each side of the amplifier, so that airflow is not obstructed. Allow 20 inches (50.8cm) depth behind the front

panel. Allow 1 inch (2.54cm) in front of the mounting panel for knob clearance. Be sure to cut out a ventilation hole in the mounting shelf according to the dimensions in the drawing.

**MA2275 Front Panel Custom Cabinet Cutout**

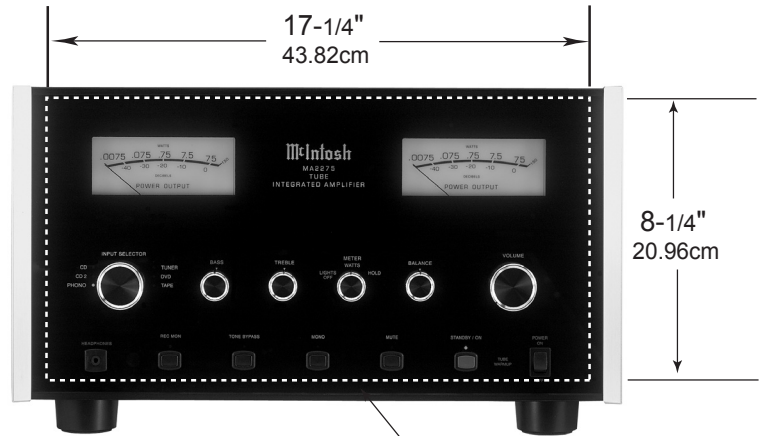

Cutout Opening for Custom Mounting

**MA2275 Side View in Custom Cabinet**

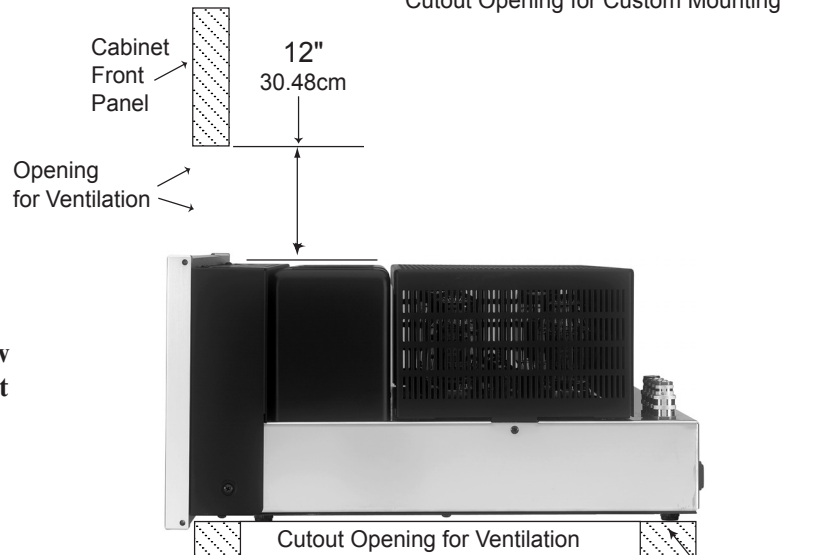

**MA2275 Bottom View in Custom Cabinet**

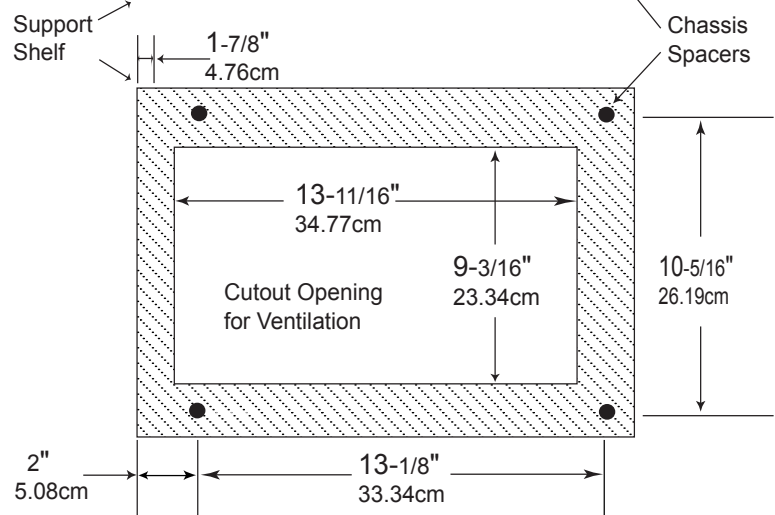



# Top Panel Connections and Tube Locations

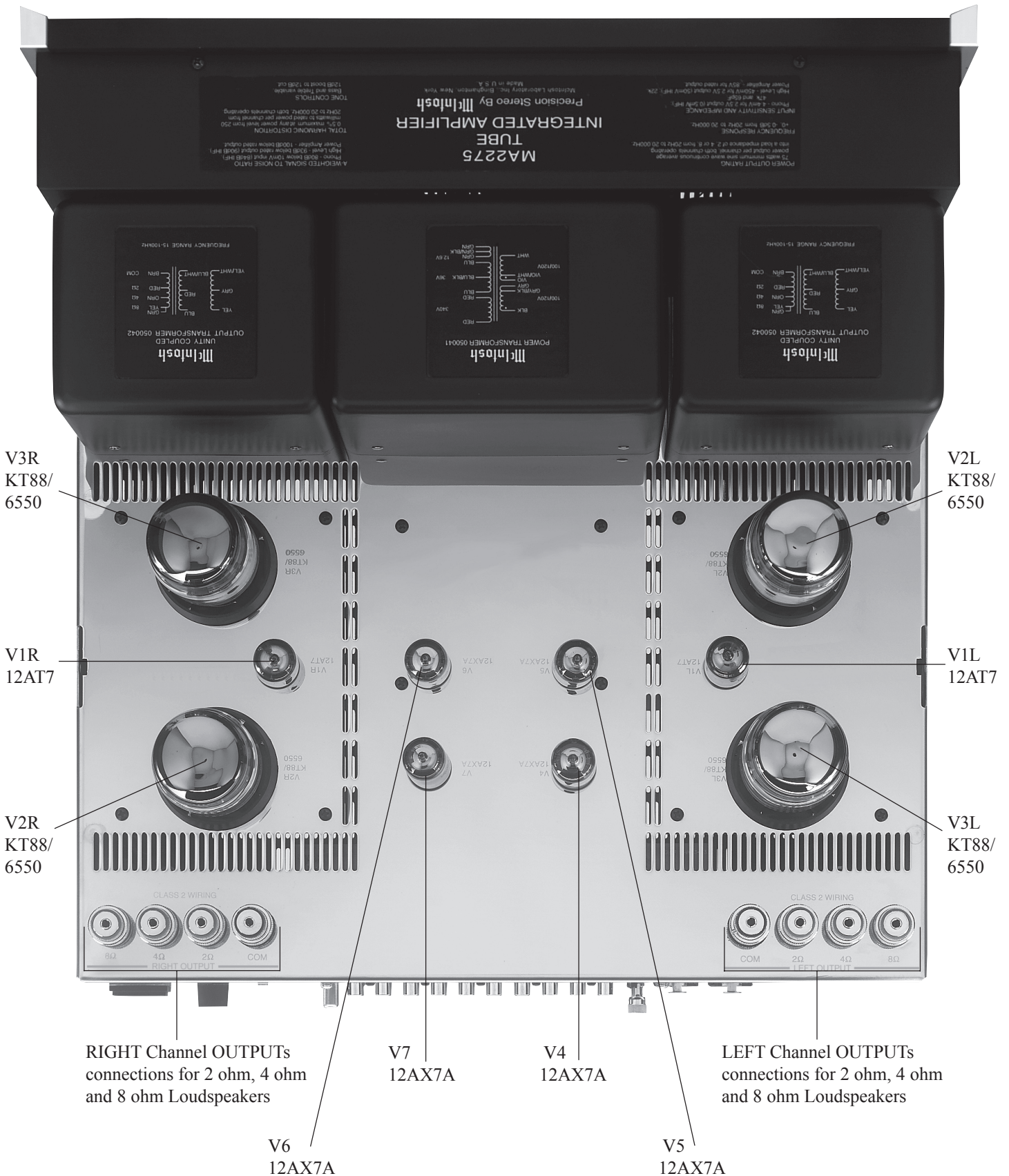

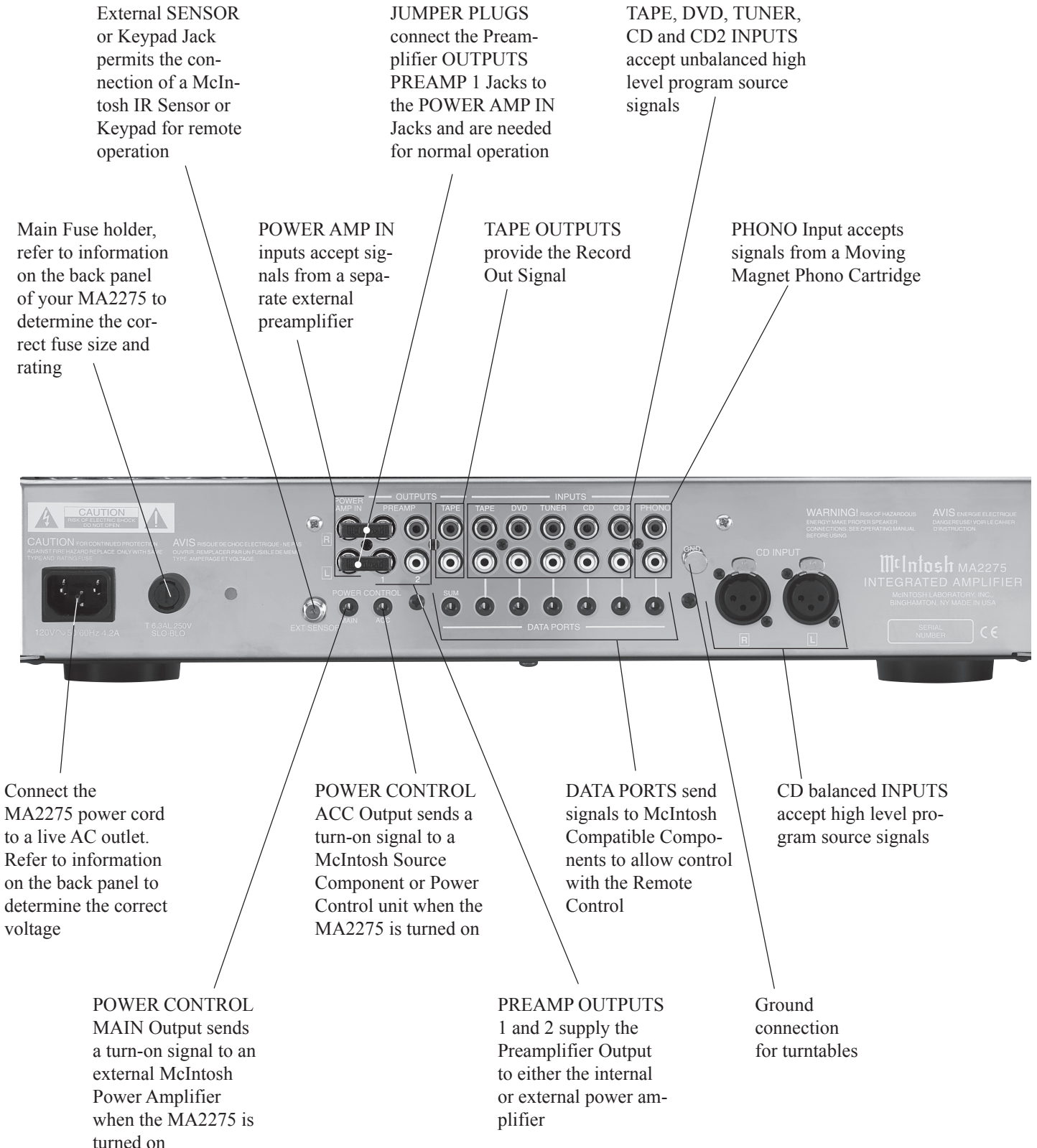

External SENSOR or Keypad Jack permits the connection of a McIntosh IR Sensor or Keypad for remote operation

JUMPER PLUGS connect the Preamplifier OUTPUTS PREAMP 1 Jacks to the POWER AMP IN Jacks and are needed for normal operation

TAPE, DVD, TUNER, CD and CD2 INPUTS accept unbalanced high level program source signals

Main Fuse holder, refer to information on the back panel of your MA2275 to determine the correct fuse size and rating

POWER AMP IN inputs accept signals from a separate external preamplifier

TAPE OUTPUTS provide the Record Out Signal

PHONO Input accepts signals from a Moving Magnet Phono Cartridge

Connect the MA2275 power cord to a live AC outlet. Refer to information on the back panel to determine the correct voltage

POWER CONTROL ACC Output sends a turn-on signal to a McIntosh Source Control Component or Power Control unit when the MA2275 is turned on

DATA PORTS send signals to McIntosh Compatible Components to allow control with the Remote Control

CD balanced INPUTS accept high level program source signals

POWER CONTROL MAIN Output sends a turn-on signal to an external McIntosh Power Amplifier when the MA2275 is turned on

PREAMP OUTPUTS 1 and 2 supply the Preamplifier Output to either the internal or external power amplifier

Ground connection for turntables

## How to Connect Loudspeakers

**Caution:** The supplied AC Power Cord should not be connected to the Rear Panel of the MA2275 Integrated Amplifier until after Connections have been made.

1. Prepare the Loudspeaker Hookup Cables that attach to the MA2275 by choosing one of the methods below:

### Bare wire cable ends:

Carefully remove sufficient insulation from the cable ends, refer to figures 1, 2 & 3. If the cable is stranded, carefully twist the strands together as tightly as possible.

*Note: If desired, the twisted ends can be tinned with solder to keep the strands together, or attach spade lug and/or banana connector.*

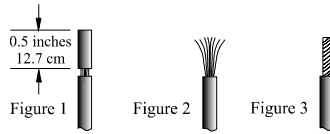

### Spade lug or prepared wire connection:

Insert the spade lug connector or prepared section of the cable end into the terminal side access hole, and tighten the terminal cap until the cable is firmly clamped into the terminal so the wires cannot slip out. Refer to figures 4, 5 & 6.

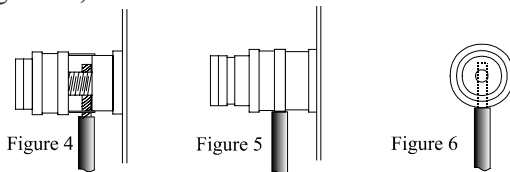

### Banana plug connection:

Insert the banana plug into the hole at the top of the terminal.

Tighten the top portion of the terminal post and the set screw to secure the banana plug in place.

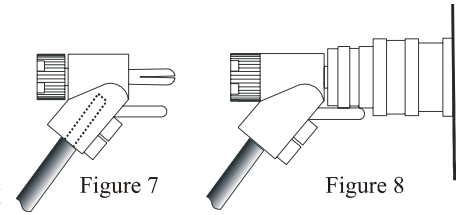

*Note: The use of Banana Plugs is for use in the United States and Canada only. Refer to figures 7 and 8.*

2. Connect the Loudspeaker hookup cables to the output terminals that match the impedance of the Loudspeaker, being careful to observe the correct polarities. Output impedance connections of 2Ω (ohm), 4Ω (ohm) and 8Ω (ohm) are provided. If the Loudspeaker's impedance is in-between the available connections, use the nearest lower impedance connection.

**WARNING:** Loudspeaker terminals are hazardous live and present a risk of electric shock. For additional instruction on making Loudspeaker Connections contact your McIntosh Dealer or McIntosh Technical Support.

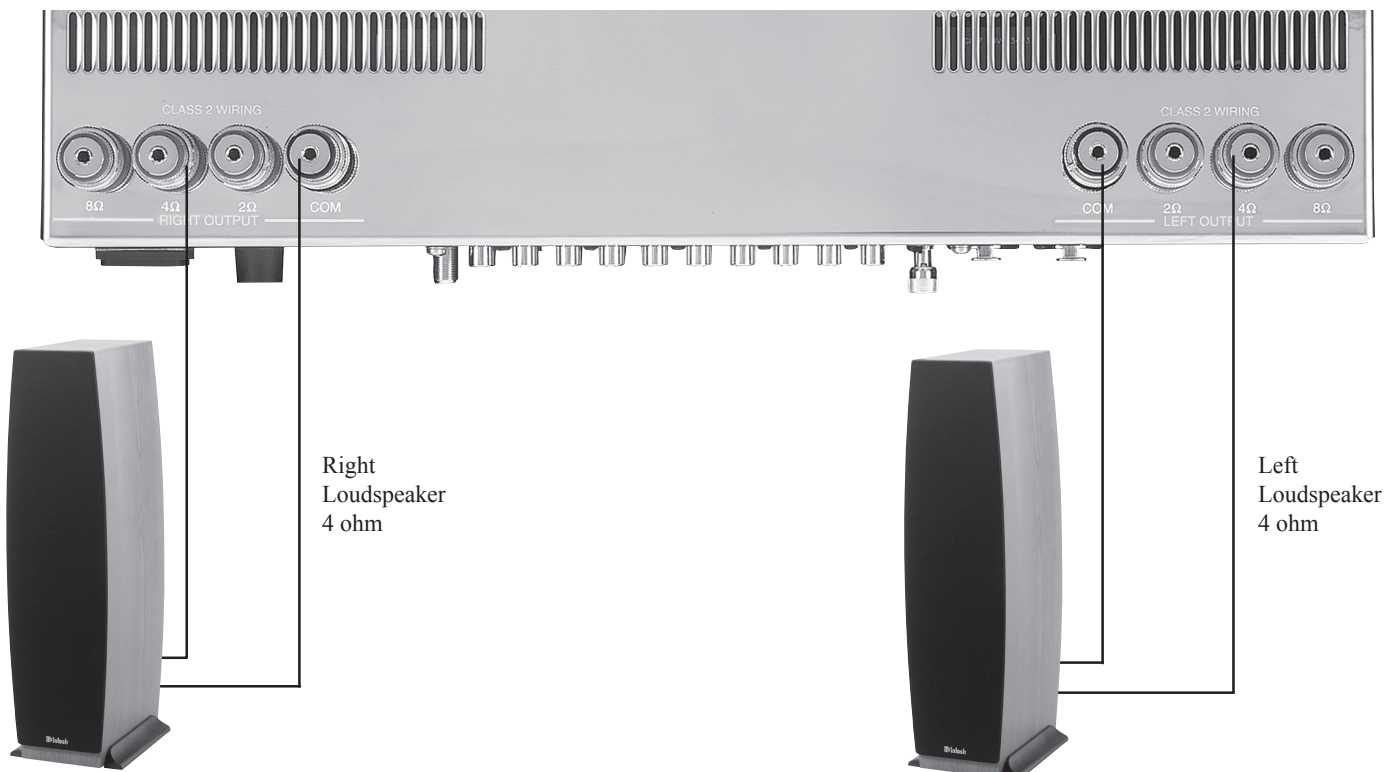

### How to Connect Audio Components

1. Connect an Audio Cable from the McIntosh CD Player Audio Outputs to the MA2275 CD INPUTS.
2. Connect an Audio Cable from the McIntosh Tuner 1 Outputs to the MA2275 TUNER INPUTS.
3. Connect an Audio Cable from a Turntable to the PHONO INPUTS and the Turntable Ground Connection to the GND grounding post.
4. Connect an Audio Cable from the MA2275 TAPE OUTPUTS to the Record Inputs of a Tape Recorder and from the MA2275 TAPE INPUTS to the Tape Recorder Outputs.
5. Connect a Control Cable from the MA2275 POWER CONTROL ACC Jack to the Power Control In on the McIntosh Tuner.
6. Connect a Control Cable from the McIntosh Tuner Power Control Out Jack to the Power Control In jack on the McIntosh CD Player.
7. Connect a Control Cable from the MA2275 TUNER DATA PORT Jack to the McIntosh Tuner Data In (Tuner 1).
8. Connect a Control Cable from the MA2275 CD2 DATA PORT Jack to the McIntosh CD Player Data In Jack.
9. Connect the MA2275 Power Cord to a live AC outlet.

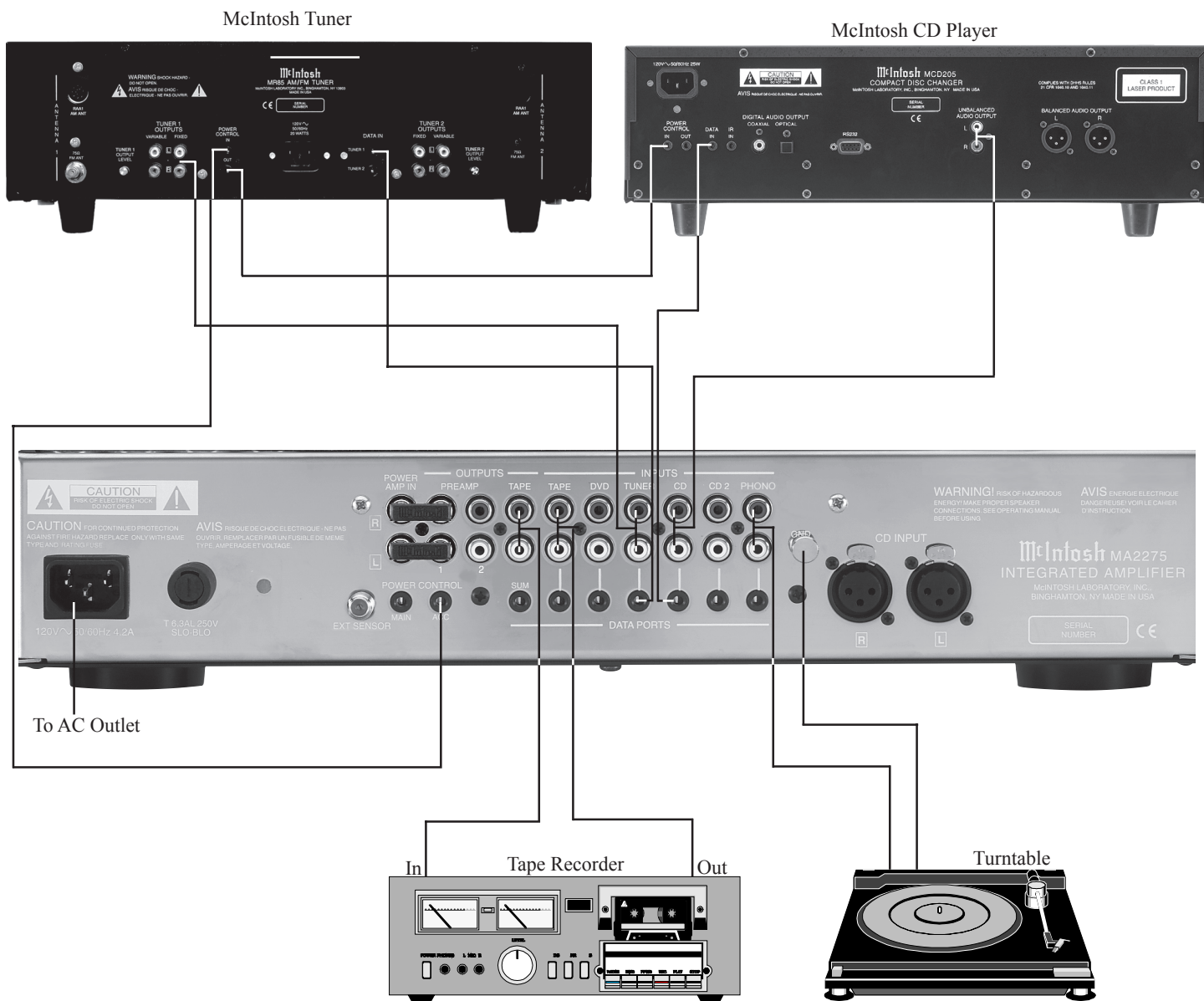

**How to Connect for a Second Room**

1. Connect Audio Cables from the MA2275 OUTPUTS PREAMP 2 to the second Power Amplifier Inputs.
2. Connect Hookup Cables from the second Power Amplifier to the Loudspeakers. Refer to page 11 in this Owner's Manual for connection details.
3. Connect a Control Cable from the MA2275 POWER CONTROL MAIN Jack to the Power Control In of a McIntosh Power Amplifier.
4. Connect an RG6 or RG59U coaxial cable from the External SENSOR Jack to a McIntosh Keypad.

*Note: A Wall Mounted IR Sensor may also be used in place of the Keypad.*

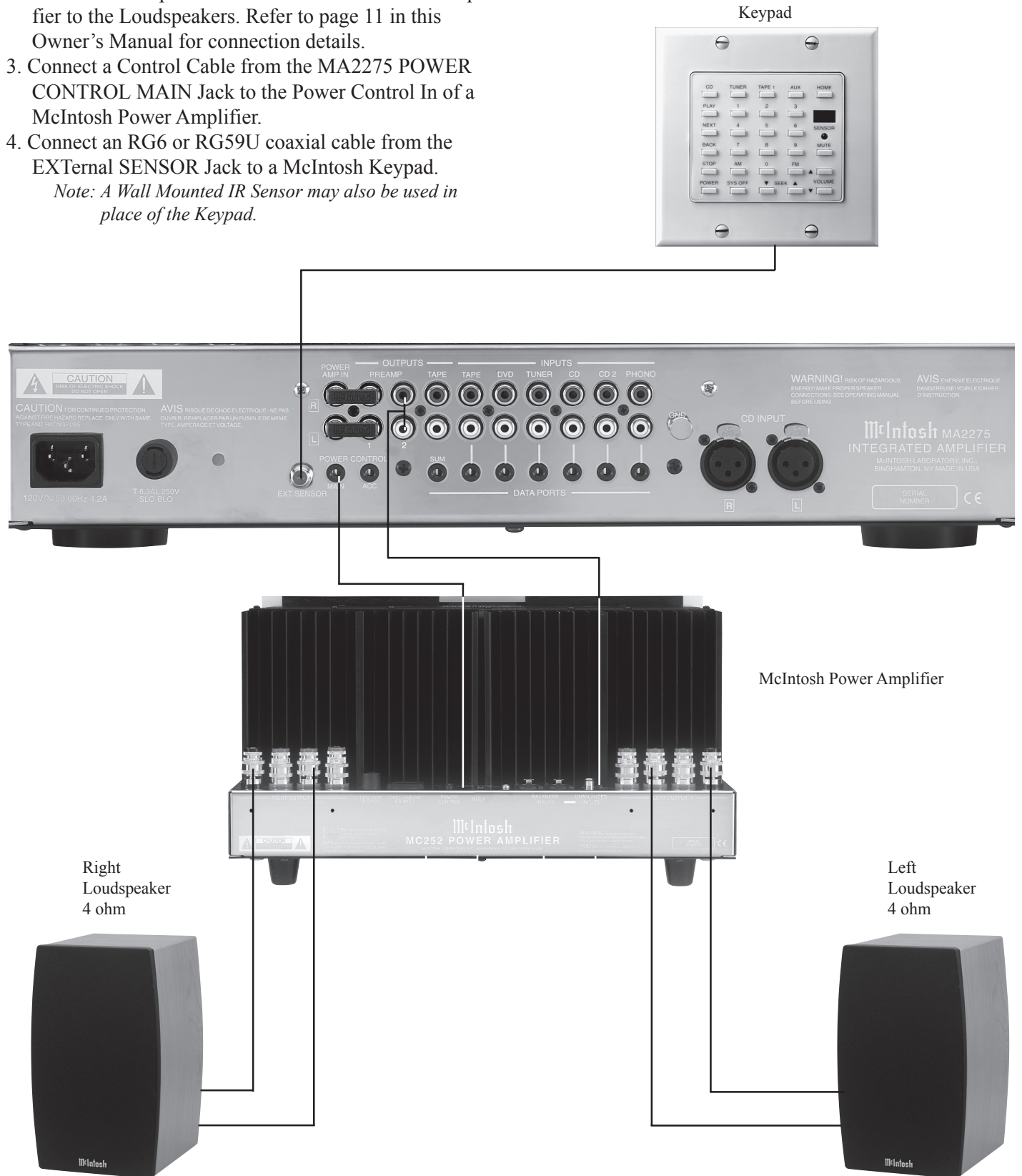

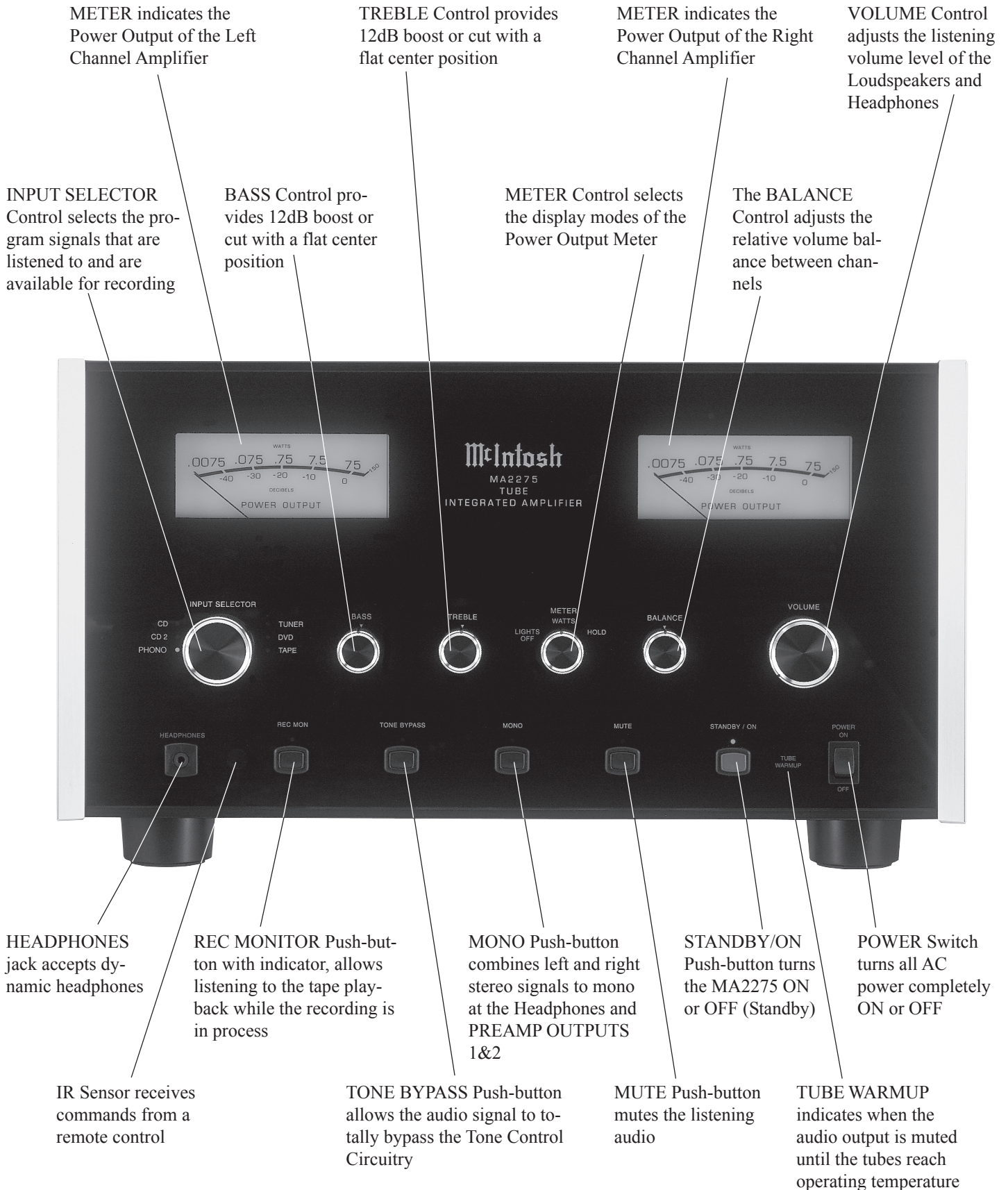

## How to Operate the MA2275

### Power On and Off

Press the POWER switch to ON, the Red LED above the STANDBY/ON Push-button lights to indicate the MA2275 is in Standby Mode. To Switch On the MA2275 press the STANDBY/ON Push-button on the Front Panel or the POWER Push-button on the Remote Control.

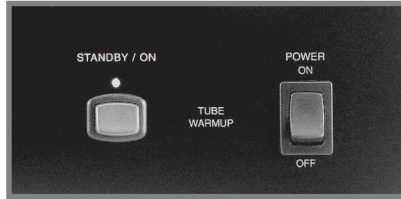

Figure 9

The title TUBE WARMUP will illuminate on the Front Panel (located to the right of the STANDBY/ON Push-button) with the Audio Outputs muted until the tubes reach operating temperature. Refer to figures 9 and 10.

*Notes:* 1. For normal operation, switch the MA2275 On and Off with the Standby/On Push-button. If the Tube Integrated Amplifier is not going to be used for an extended period of time, turn Off all AC Power with the Power Switch on the Front Panel.

2. The amount of time required for Tube Warmup is dependant upon the temperature of the Tubes inside the MA2275 when the STANDBY/ON Push-button is depressed.

3. If there is an interruption of AC Power to the MA2275 while it is On, the internal circuitry will sense this condition and will automatically switch the MA2275 back On when AC Power is restored.



Figure 10

### Input Source Selection

Select the desired Source with the INPUT Selector Control or the Source Push-button on the Remote Control.

*Note:* For an explanation of the Remote Control Push-button functions, refer to pages 18 and 19.

### Bass and Treble Controls

Adjust the BASS and TREBLE controls to suit your listening preferences. The Bass or Treble intensity can be increased with clockwise rotation and decreased with counterclockwise rotation.

### Meter Mode Selection

Rotate the Meter Mode Switch to select the meter operation mode you desire. Refer to figure 11 and 12.

**Lights Off** - Meter lights are turned off and the meter will continue to indicate the power output.

**Watts** - The meters respond to all the musical information being produced by the amplifier. They indicate to an accuracy of at least 95% of the power output with only a single cycle of a 2000Hz tone burst.

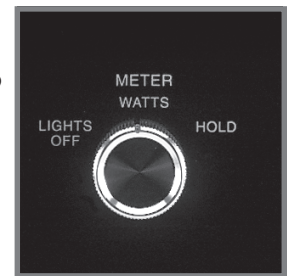

Figure 11

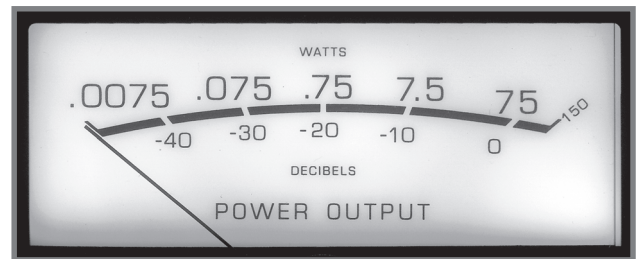

Figure 12

**Hold** - The meter pointer is locked to the highest power peak in a sequence of peaks. It is electronically held to this power level until a higher power peak passes through the amplifier. The meter pointer will then rise to the newer higher indication. If no further power peaks are reached, the meter pointer will very slowly return to its rest position or lower power level. The decay rate is approximately 6dB per minute.

### Balance Control

Adjust the BALANCE Control as needed to achieve approximately equal listening volume levels in each Loudspeaker. Rotate the BALANCE Control clockwise to emphasize the Right Channel by reducing the volume level of the Left Channel. Rotate the BALANCE Control counterclockwise to de-emphasize the Right Channel until equal Balance of both Channels is achieved.

### Volume Control

Adjust the VOLUME Control or press the Up▲ /Down▼ Push-buttons on the Remote Control for the desired listening level. Refer to figure 13.

### Record Monitor

Press the REC MONITOR Push-button to hear the TAPE Playback Signal during the recording process. Refer to figure 14.

### Tone Bypass

Press the TONE BYPASS Push-button to totally Bypass the Tone Control Circuitry, providing a flat frequency response.

*Note: The MA2275 will automatically remember for each input whether the Tone Bypass is active.*

### Mono

Press the MONO Mode Push-button to combine Left and Right Stereo Signals to Mono, for the Loudspeaker Outputs, PREAMP OUTPUTS 1&2 and the HEADPHONES Jack. The MODE Push-button on the Remote Control also can be used to switch between the Stereo and Mono Modes of Operation. Refer to figure 13.

*Note: The TAPE Outputs are not effected by the Mono Mode of Operation.*

### Mute

Press the MUTE Push-button to Mute the Audio at the Loudspeaker Outputs and PREAMP OUTPUTS 1 & 2. An LED above MUTE Push-button, on the front panel, will flash On and Off during the time the audio is muted.



Figure 13

### Reset of Microprocessors

In the event the controls of the MA2275 stop functioning, push the POWER switch OFF and wait about two minutes. Then push the POWER switch ON followed by pushing the STANDBY/ON Push-button. This will reset the MA2275 microprocessors and the Tube Integrated Amplifier should be functioning normally.

*Note: The above condition is usually caused by either interruptions in AC power and/or major changes that may occur in AC power line voltage.*

### Using a Separate Power Amplifier

There are two different ways to use a separate power amplifier with a MA2275. The first way is to use the separate amplifier instead of the MA2275 built-in Power Amplifier. Connect the Loudspeakers to the separate power amplifier and remove the McIntosh Jumpers that are located between the OUTPUTS 1 Jacks and the POWER AMP INPUT Jacks. Refer to figures 15 and 16.

*Note: The McIntosh Jumpers must be connected, between the above mentioned jacks, when the MA2275 Internal Power Amplifier is to be used.*

The second way is to use both a separate power amplifier and the MA2275 built-in Power Amplifier. Connect one pair of Loudspeakers to the separate power amplifier and the second pair to the MA2275. Refer to page 13 for connection information.

*Note: The MA2275 VOLUME Control will affect the sound level of all the Loudspeakers.*



Figure 15



Figure 16

### How To Make A Tape Recording

1. Select the source signal you wish to record using the INPUT SELECTOR Control.
2. Adjust the record level using the tape recorder volume control and proceed with the recording process.
3. Press the REC MON Push-button and listen to the tape playback of the just recorded program source selected.

*Note: The MA2275 TAPE OUTPUTS are not affected by the VOLUME or BALANCE controls.*

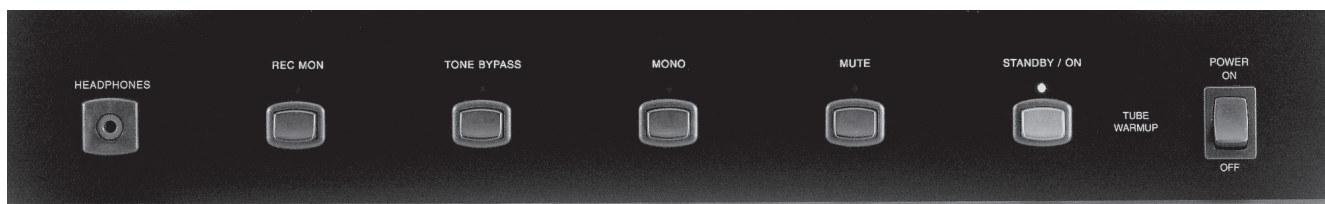
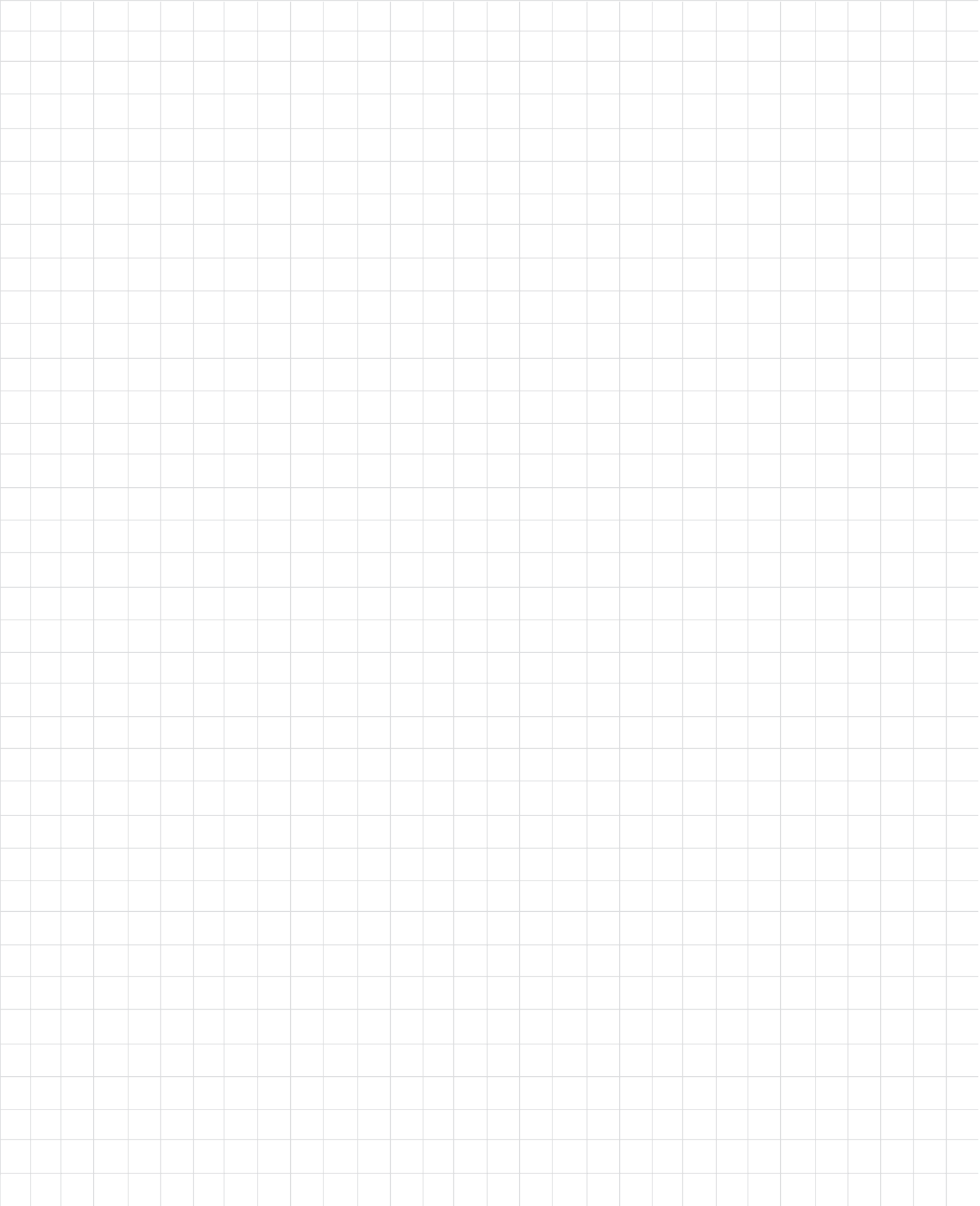
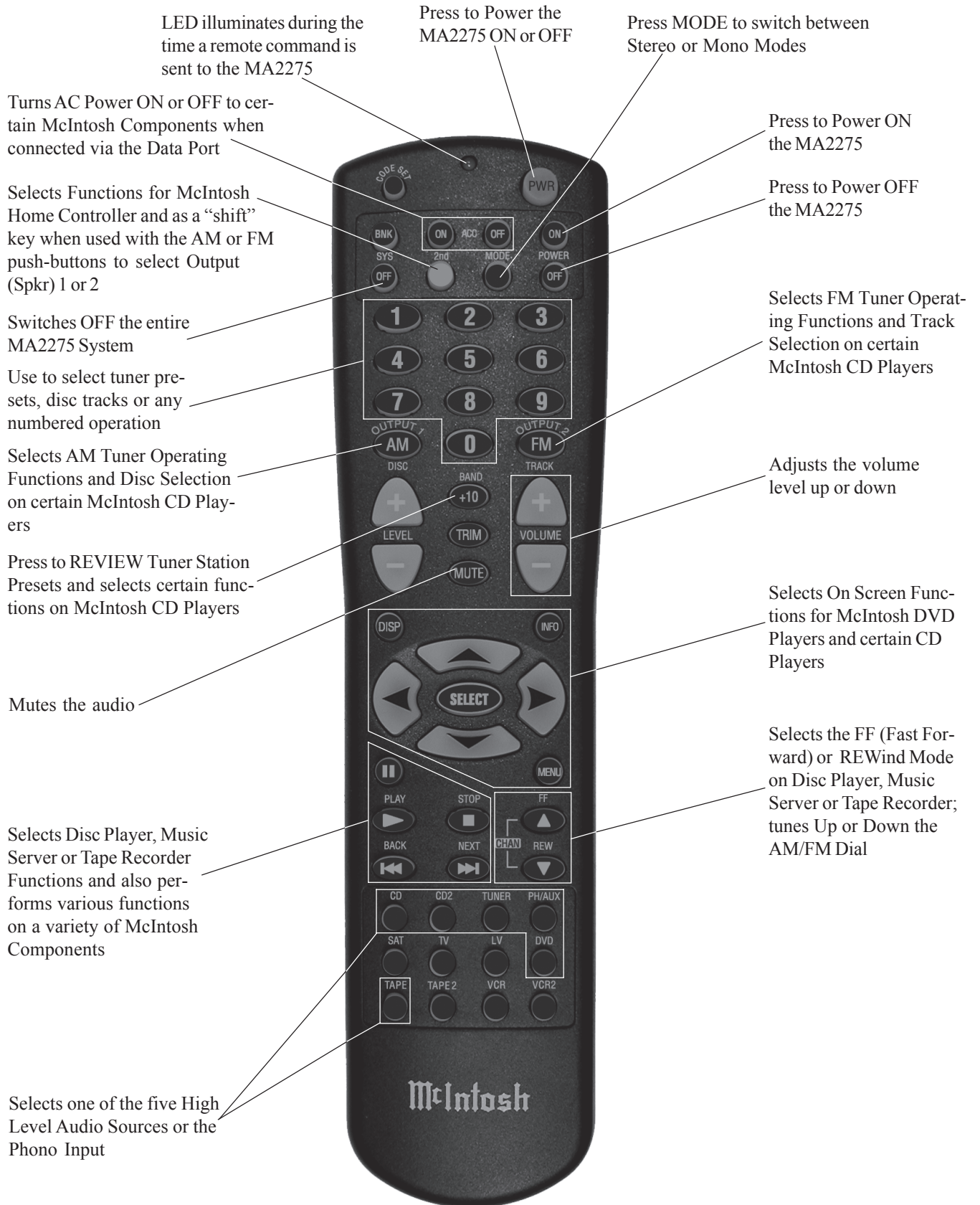

Figure 14

*Note: For an explanation of the Remote Control Push-button functions, refer to pages 18 and 19.*







*Note: Push-buttons whose function is not identified above are for use with other McIntosh Products.*

### How to Operate by Remote Control

---

The supplied Remote Control is capable of directly controlling the functions of contemporary McIntosh Source Components connected to the MA2275. Earlier McIntosh source components and other brand source components can be controlled by the MA2275 Remote Control with the addition of a McIntosh Remote Control Translator (RCT).

*Note: Your McIntosh Dealer can assist you with the installation and operation of the Remote Control Translator (RCT).*

#### **Mute**

Press the MUTE Push-button to mute audio at the Loudspeaker and Headphone Outputs. Press MUTE a second time to unmute audio.

#### **Mode**

Press the MODE Push-button to select between Stereo and Mono Modes of operation.

#### **Input Source Selection**

Press one of the Input Push-buttons to select the desired program source.

#### **Disc Player, Music Server or Tape Recorder Functions**

Use these push-buttons to operate a Disc Player or Tape Recorder.

#### **Numbered Push-buttons**

Press Push-buttons 0 through 9 to access tuner station presets or Disc chapters/tracks/discs.

#### **Disc and Track**

Use the DISC and TRACK Push-buttons when a Disc Player, Music Server or Tape Recorder is being used.

*Note: Certain Disc Players will require a Numbered Push-button be pressed immediately after the Disc or Track Push-button is depressed.*

#### **Volume**

Press the Up▲ or Down▼ VOLUME Push-button to raise or lower the listening volume level.

*Note: The TAPE OUTPUTS are not affected by volume changes.*

#### **Tuner Push-buttons**

Press the AM or FM push-button to select the desired broadcast band. Press and release the CHANnel Up▲ or Down▼ push-button to move from station to station. Press and hold a CHANnel Up▲ or Down▼ push-button to

move continuously from station to station. Press the +10 Push-button to start the automatic brief audition of each of the presets stored in the tuner memory. Press the +10 Push-button a second time to stop on a station preset and exit the review process.

#### **Acc On/Acc Off**

Press ACC ON Push-button to switch the power ON to certain McIntosh Disc Players. Press ACC OFF Push-button to switch the power OFF to certain McIntosh Disc Players. The ACC ON/OFF Push-buttons also control the signal at the ACCESSORY(B) Power Control Jack; it will also remember the last command when the MA2275 is switched Off and On again.

#### **Pause**

Press **||** to perform various functions on a variety of McIntosh Components. It will also pause the playing of a Disc or Tape playback.

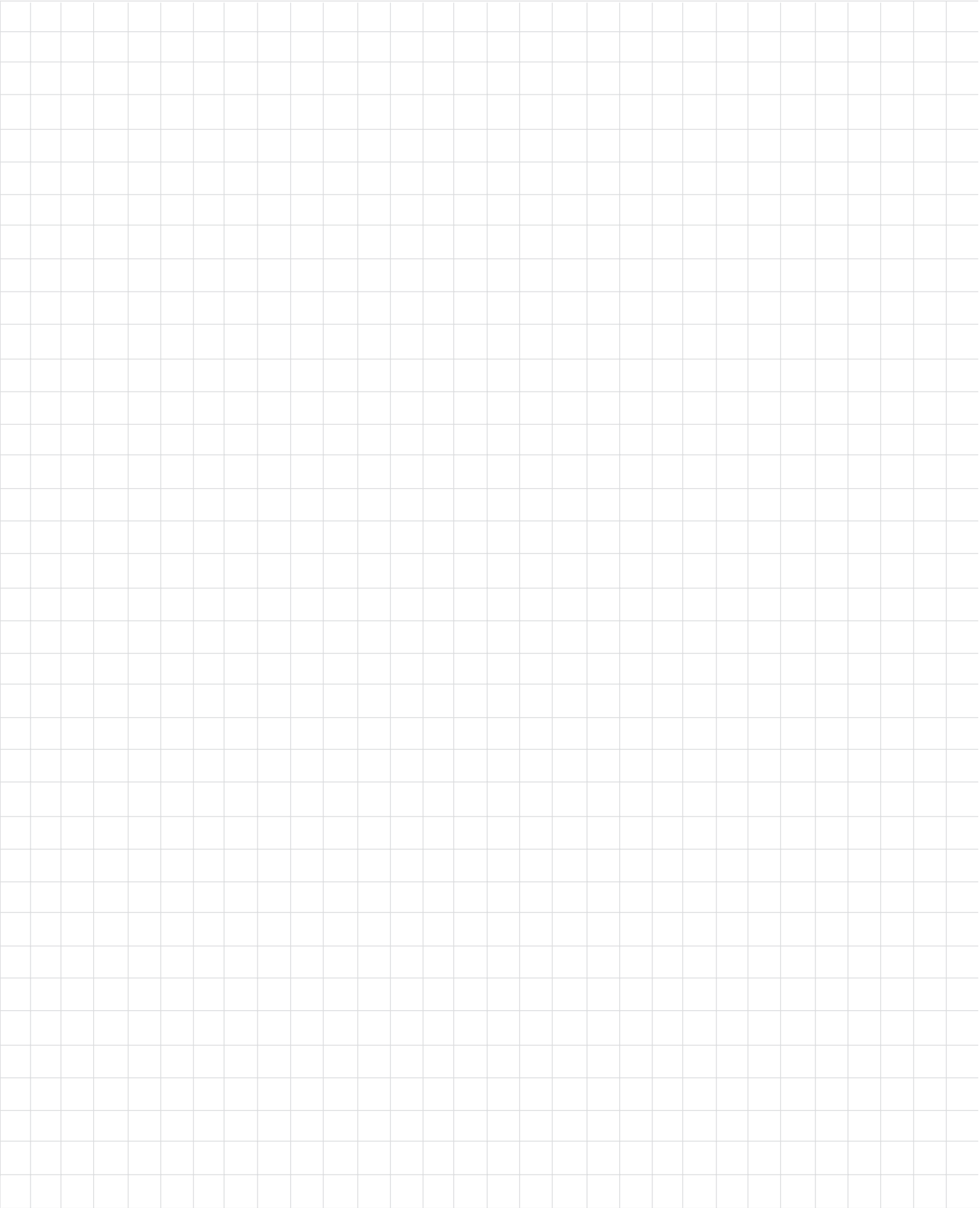

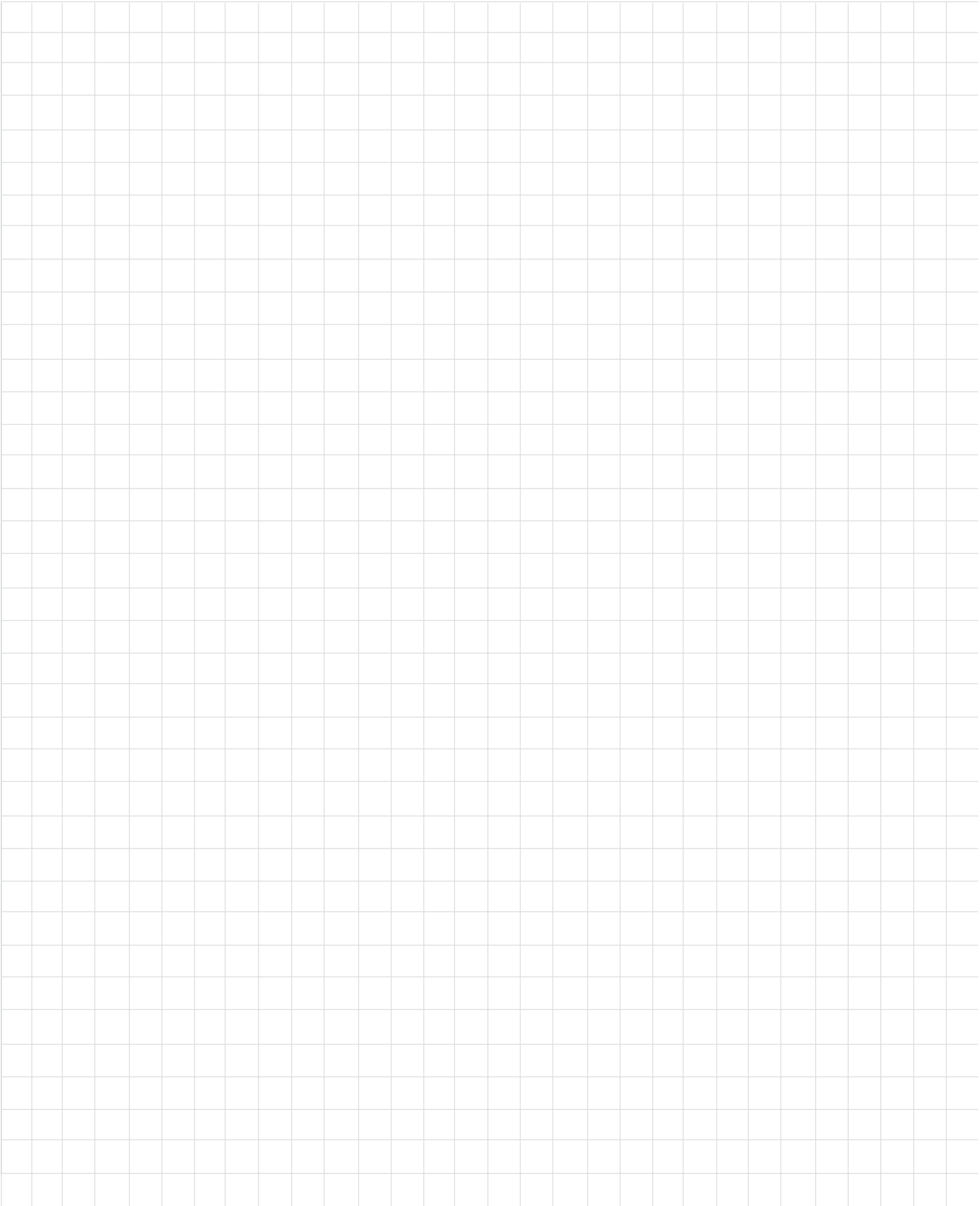

### Specifications

---

#### Power Output

Minimum sine wave continuous average power output per channel, both channels operating is:

75 watts into a 2 ohm load

75 watts into a ohm load

75 watts into an 8 ohm load

#### Rated Power Band

20Hz to 20,000Hz

#### Total Harmonic Distortion

Maximum Total Harmonic Distortion at any power level from 250 milliwatts to rated power output is:

0.5% for a 2, 4 or 8 ohm load

#### Frequency Response

+0, -0.5dB from 20Hz to 20,000Hz

+0, -3dB from 10Hz to 50,000Hz

#### Sensitivity

Phono: 4.4mV for 2.5V rated output

High Level: 450mV for 2.5V rated output

Power Amplifier Input: 2.5V for rated output

#### A-Weighted Signal To Noise Ratio

Phono Input: 80dB below 10mV input

High Level: 97dB below rated output

Power Amplifier: 110dB below rated output

#### Intermodulation Distortion

Maximum Intermodulation Distortion if instantaneous peak output does not exceed twice the rated output, for any combination of frequencies from 20Hz to 20,000Hz is:

0.5% for a 2, 4 or 8 ohm load

#### Input Impedance

Phono: 47K ohms, 65pF

High: Level, 22K ohms

#### Maximum Input Signal

Phono: 90mV

High Level: 8V

#### Preampifier Maximum Voltage Output

Phono: 8V

High Level: 8V

Main Out: 8V at preamp output

#### Voltage Gain

High Level to Tape: 0dB

High Level to Main: 15dB

#### Wide Band Damping Factor

Greater than 18

#### Power Requirements

100 Volts, 50/60Hz at 3.6 amps

110 Volts, 50/60Hz at 3.6 amps

120 Volts, 50/60Hz at 3.6 amps

220 Volts, 50/60Hz at 1.8 amps

230 Volts, 50/60Hz at 1.8 amps

240 Volts, 50/60Hz at 1.8 amps

*Note: Refer to the rear panel of the MA2275 for the correct voltage.*

#### Preampifier Tube Compliment

2 - 12AX7A Phono Circuitry

2 - 12AX7A High Level Circuitry

#### Power Amplifier Tube Compliment

2 - 12AT7

4 - KT88/6550

#### Overall Dimensions

Width is 17-3/4 inches (45.09cm)

Height is 10-1/8 inches (25.72cm) including feet

Depth is 18-3/4 inches (47.63cm) including the Front Panel and Knobs

#### Weight

77 pounds (35 kg) net, 110 pounds (50 kg) in shipping carton

**Packing Instructions**

In the event it is necessary to repack the equipment for shipment, the equipment must be packed exactly as described and shown below.

The MA2275 Vacuum Tubes must be removed from the Amplifier Tube Sockets and placed into the inside openings of the five layer foam packing material. The foam with the tubes located inside are placed into the Amplifier Tube Cover and secured to the Chassis. Failure to do this will result in damage to the Vacuum Tubes and possibly the MA2275.

Four 1/4 - 20 x 2-1/4 inch cap screws and flat washers must be used to fasten the unit securely to the Shipping Skid. This will ensure the proper equipment location in the Inner Carton. Failure to do this will result in shipping damage.

Use the original shipping carton and interior parts only if they are all in good serviceable condition. If a shipping carton or any of the interior part(s) are needed, please call or write Customer Service Department of McIntosh Laboratory. Please see the Part List for the correct part numbers.

Quantity	Part Number	Description
1	034052	Shipping carton top
1	034051	Shipping carton bottom
2	034054	Foam Pad (top and bottom)
2	034186	Foam Pad (front and rear)
2	034187	Foam Pad (sides)
2	034180	Foam pack tube (ends)
2	034179	Foam pack tube (inside with tube cutouts)
1	034136	Inner carton top
1	034137	Inner carton bottom
1	034008	Bottom pad
1	034161	Shipping skid
4	101212	1/4 - 20x2-1/4 cap screw
4	104058	Flat washer

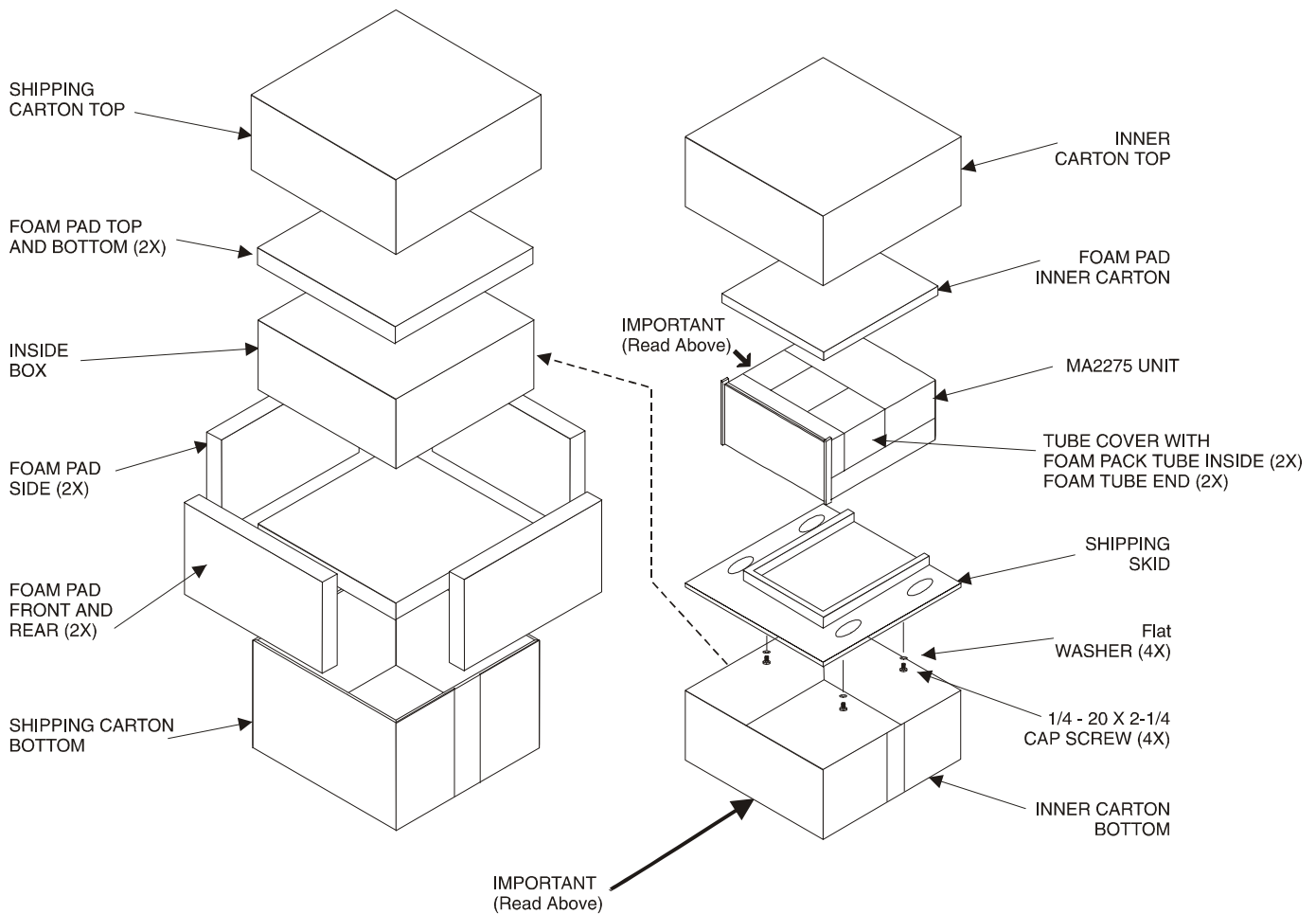



McIntosh Laboratory, Inc.  
2 Chambers Street  
Binghamton, NY 13903

The continuous improvement of its products is the policy of McIntosh Laboratory Incorporated who reserve the right to improve design without notice.

Printed in the U.S.A.

McIntosh Part No. 04099200