



McIntosh Laboratory, Inc. 2 Chambers Street Binghamton, New York 13903-2699 Phone: 607-723-3512 www.mcintoshlabs.com

MA6300
Integrated Amplifier
Owner's Manual



The lightning flash with arrowhead, within an equilateral triangle, is intended to alert the user to the presence of uninsulated “dangerous voltage” within the product’s enclosure that may be of sufficient magnitude to constitute a risk of electric shock to persons.

WARNING - TO REDUCE RISK OF FIRE OR ELECTRICAL SHOCK, DO NOT EXPOSE THIS EQUIPMENT TO RAIN OR MOISTURE.



AVIS RISQUE DE CHOC ELECTRIQUE - NE PAS OUVRIR.

NO USER-SERVICEABLE PARTS INSIDE. REFER SERVICING TO QUALIFIED PERSONNEL.

The exclamation point within an equilateral triangle is intended to alert the user to the presence of important operating and maintenance (servicing) instructions in the literature accompanying the appliance.

To prevent the risk of electric shock, do not remove cover or back. No user-serviceable parts inside.

IMPORTANT SAFETY INSTRUCTIONS!

PLEASE READ THEM BEFORE OPERATING THIS EQUIPMENT.

1. Read these instructions.
2. Keep these instructions.
3. Heed all warnings.
4. Follow all instructions.
5. Do not use this apparatus near water.
6. Clean only with a dry cloth.
7. Do not block any ventilation openings. Install in accordance with the manufacturer’s instructions.
8. Do not install near any heat sources such as radiators, heat registers, stoves, or other apparatus (including amplifiers) that produce heat.
9. Do not defeat the safety purpose of the polarized or grounding-type plug. A polarized plug has two blades with one wider than the other. A grounding type plug has two blades and a

third grounding prong. The wide blade or the third prong are provided for your safety. If the provided plug does not fit into your outlet, consult an electrician for replacement of the obsolete outlet.

10. Protect the power cord from being walked on or pinched particularly at plugs, convenience receptacles, and the point where they exit from the apparatus.
11. Only use attachments/accessories specified by the manufacturer.
12. Use only with the cart, stand, tripod, bracket, or table specified by the manufacturer, or sold with the apparatus. When a cart is used, use caution when moving the cart/apparatus combination to avoid injury from tip-over.
13. Unplug this apparatus during lightning storms or when unused for long periods of time.
14. Refer all servicing to qualified service personnel. Servicing is required when the apparatus has been damaged in any way, such as power-



supply cord or plug is damaged, liquid has been spilled or objects have fallen into the apparatus, the apparatus has been exposed to rain or moisture, does not operate normally, or has been dropped.

15. Do not expose this equipment to dripping or splashing and ensure that no objects filled with liquids, such as vases, are placed on the equipment.
16. To completely disconnect this equipment from the a.c. mains, disconnect the power supply cord plug from the a.c. receptacle.
17. The mains plug of the power supply cord shall remain readily operable.
18. Do not expose batteries to excessive heat such as sunshine, fire or the like.
19. Connect mains power supply cord only to a mains socket outlet with a protective earthing connection.

Thank You

Your decision to own this McIntosh MA6300 Integrated Amplifier ranks you at the very top among discriminating music listeners. You now have “The Best.” The McIntosh dedication to “Quality,” is assurance that you will receive many years of musical enjoyment from this unit.

Please take a short time to read the information in this manual. We want you to be as familiar as possible with all the features and functions of your new McIntosh.

Please Take A Moment

The serial number, purchase date and McIntosh Dealer name are important to you for possible insurance claim or future service. The spaces below have been provided for you to record that information:

Serial Number: _____

Purchase Date: _____

Dealer Name: _____

Technical Assistance

If at any time you have questions about your McIntosh product, contact your McIntosh Dealer who is familiar with your McIntosh equipment and any other brands that may be part of your system. If you or your Dealer wish additional help concerning a suspected problem, you can receive technical assistance for all McIntosh products at:

McIntosh Laboratory, Inc.
2 Chambers Street
Binghamton, New York 13903
Phone: 607-723-3512
Fax: 607-724-0549

Customer Service

If it is determined that your McIntosh product is in need of repair, you can return it to your Dealer. You can also return it to the McIntosh Laboratory Service Department. For assistance on factory repair return procedure, contact the McIntosh Service Department at:

McIntosh Laboratory, Inc.
2 Chambers Street
Binghamton, New York 13903
Phone: 607-723-3515
Fax: 607-723-1917

Table of Contents

Safety Instructions	2
Thank You and Please Take a Moment.....	3
Technical Assistance and Customer Service	3
Table of Contents	3
General Information	3
Connector and Cable Information	4
Introduction.....	4
Performance Features	4
Dimensions	5
Installation	6
Connections:	
Rear Panel Connections	7
How to Connect Power and Data Control.....	8
How to Connect Audio Components	9
How to Connect Loudspeakers.....	10
How to Connect an external Power Amplifier	12
Front Panel Features:	
Front Panel Displays, Controls, Push-buttons and Jack.....	13
Operation:	
How to Operate the MA6300.....	14

Remote Control:

Remote Control Push-buttons.....	16
How to Operate by Remote Control	17

Additional Information:

Specifications.....	18
Packing Instruction.....	19

General Information

1. For additional connection information, refer to the owner’s manual(s) for any component(s) connected to the MA6300 Integrated Amplifier.
2. The Main AC Power going to the MA6300 and any other McIntosh Component(s) should not be applied until all the system components are connected together. Failure to do so could result in malfunctioning of some or all of the system’s normal operations. When the MA6300 and other McIntosh Components are in their Standby Power Off Mode, the Microprocessor’s Circuitry inside each component is active and communication is occurring between them.
3. The Remote Control Supplied with the MA6300 Integrated Amplifier is capable of operating other components. For additional information go to www.mcintoshlabs.com.

Connector and Cable Information

XLR Connectors

Below is the Pin configuration for the XLR Balanced Input Connectors on the MA6300. Refer to the diagram for connection:

- PIN 1: Shield/Ground
- PIN 2: + Output
- PIN 3: - Output

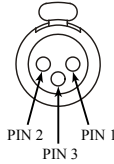

Power Control Connector

The MA6300 Power Control Output Jack sends Power On/Off Signals when connected to other McIntosh Components. A 1/8 inch stereo mini phone plug is used for connection to the Power Control Output on the MA6300.

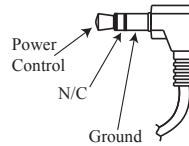

Note: The Data and Power Control Connecting Cable is available from the McIntosh Parts Department:

Data and Power Control Cable Part No. 170-202
Six foot, shielded 2 conductor, with 1/8 inch stereo mini phone plugs on each end.

Data Port Connectors

The MA6300 Data Out Ports send Remote Control Signals to McIntosh Source Components. A 1/8 inch stereo mini phone plug is used for connection.

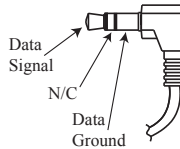

McIntosh Plug-In Jumper Connector

The MA6300 utilizes a phono style Plug-In Jumper to connect the MAIN OUTPUT (Preamplifier Output) jack to the POWER AMPLIFIER INPUT jack for each channel.

Note: The Jumper Connector is available from the McIntosh Parts Department:

McIntosh Jumper Connector Part No. 117-781

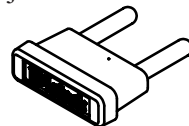

Introduction

Now you can take advantage of traditional McIntosh standards of excellence in the MA6300 Integrated Amplifier. The Power Amplifier section of the MA6300, with a power output of 100 watts per channel, will drive a pair of quality loudspeakers to a high level of performance. The flexible Preamplifier section provides connections for various input sources and may also be used to drive an external Power Amplifier. The MA6300 reproduction is sonically transparent and absolutely accurate. The McIntosh Sound is "The Sound of the Music Itself."

Performance Features

• Power Output

The MA6300 consists of a 100 watts per channel stereo Power Amplifier and a sophisticated Preamplifier in one compact unit with less than 0.005% distortion.

• Electronic Input Switching and Balanced Input

Digital Logic integrated circuits drive Electromagnetic switches on all seven inputs and operating functions for reliable, noiseless, distortion free switching. The Balanced Input allows the connection of a source component using long cable lengths, without a loss in sound quality.

• Power Guard

The patented McIntosh Power Guard circuit prevents the amplifier from being over driven into clipping with its harsh distorted sound that can also damage your valuable loudspeakers.

• Sentry Monitor and Thermal Protection

McIntosh Sentry Monitor power output stage protection circuits ensure the MA6300 will have a long and

trouble free operating life. Built-in thermal protection circuits guard against overheating.

• Illuminated Power Meters

The Illuminated Power Output Watt Meters on the MA6300 are peak responding, and indicate the power output of the amplifier.

• Power Control

The Power Control Output connection provides convenient Turn-On/Off of McIntosh Source Components connected to the MA6300.

• Remote Control

The Remote Control provides control of the MA6300 operating functions and any McIntosh Source Components connected to it.

• Special Power Supply

A regulated Power Supply and a special R-Core Power Transformer, ensures stable noise free operation even though the power line varies.

• Fiber Optic Solid State Front Panel Illumination

The even Illumination of the Front Panel is accomplished by the combination of custom designed Fiber Optic Light Diffusers and extra long life Light Emitting Diodes (LEDs). The glass Front Panel ensures the pristine beauty of the MA6300 will be retained for many years.

Dimensions

The following dimensions can assist in determining the best location for your MA6300. There is additional information on the next page pertaining to installing the MA6300 into cabinets.

Front View of the MA6300

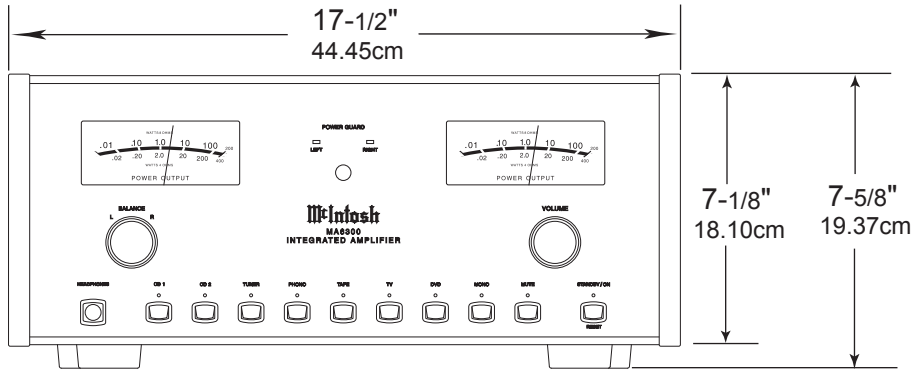

Rear View of the MA6300

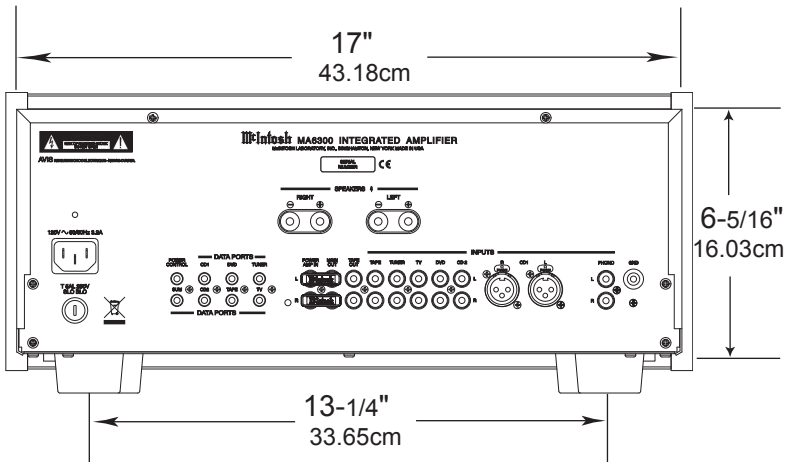

Side View of the MA6300

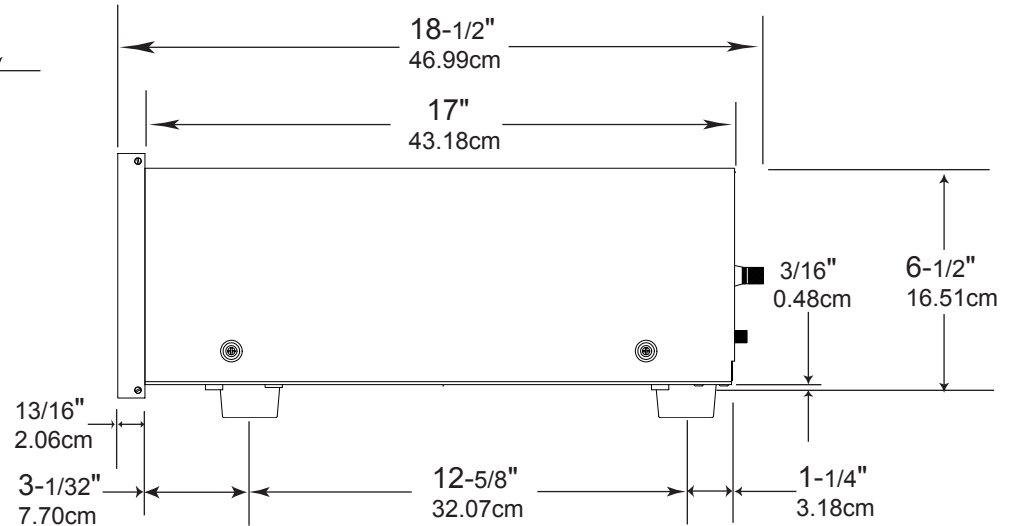

Installation

The MA6300 can be placed upright on a table or shelf, standing on its four feet. It also can be custom installed in a piece of furniture or cabinet of your choice. The four feet may be removed from the bottom of the MA6300 when it is custom installed as outlined below. The four feet together with the mounting screws should be retained for possible future use if the MA6300 is removed from the custom installation and used free standing. The required panel cutout, ventilation cutout and unit dimensions are shown.

Always provide adequate ventilation for your MA6300. Cool operation ensures the longest possible operating life for any electronic instrument. Do not install the MA6300 directly above a heat generating component such as a high powered amplifier. If all the components are installed in a single cabinet, a quiet running ventilation fan can be a definite asset in maintaining all the system components at the coolest possible operating temperature.

A custom cabinet installation should provide the following minimum spacing dimensions for cool operation.

Allow at least 6 inches (15.24cm) above the top, 2 inches (5.08cm) below the bottom and 1 inch (2.54cm) on each side of the Integrated Amplifier, so that air-flow is not obstructed. Allow 19-1/2 inches (49.53cm) depth behind the front panel. Allow 1-1/8 inch (2.9cm) in front of the mounting panel for knob clearance. Be sure to cut out a ventilation hole in the mounting shelf according to the dimensions in the drawing.

**MA6300 Front Panel
Custom Cabinet Cutout**

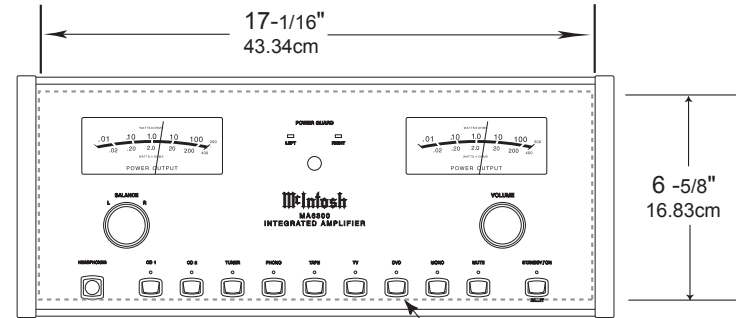

**MA6300 Side View
in Custom Cabinet**

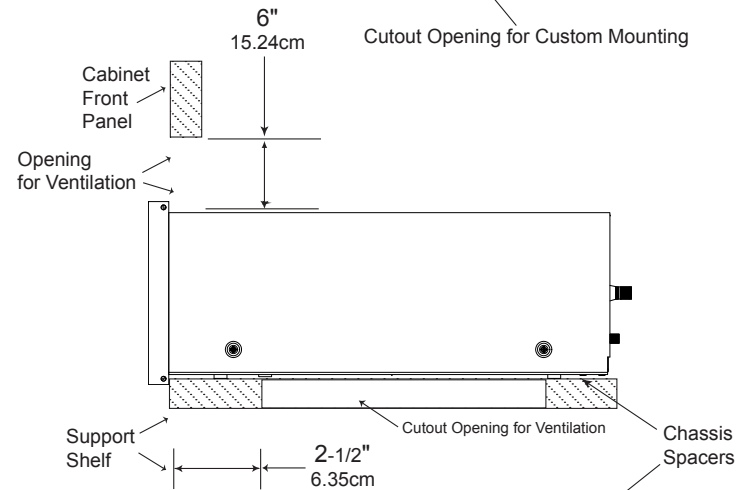

**MA6300 Bottom View
in Custom Cabinet**

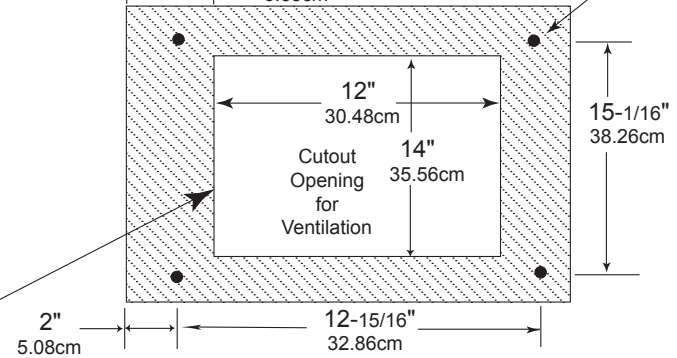

Note: Center the cutout Horizontally on the unit.
For purposes of clarity, the above illustration is not drawn to scale.

POWER CONTROL Output sends a turn-on signal to a McIntosh Source Component or Power Control unit when the MA6300 is turned on

JUMPER PLUGS connect the Preamp MAINOUT Jacks to the POWER AMP IN Jacks and are needed for normal operation

SPEAKERS LEFT output connections for 4 or 8 ohm loudspeakers

PHONO accepts signals from a Moving Magnet phono cartridge

Connect the MA6300 power cord to a live AC outlet. Refer to information on the back panel of your MA6300 to determine the correct voltage for your unit

DATA PORTS send signals to McIntosh Source Components to allow control with the MA6300 Remote Control

SPEAKERS RIGHT output connections for 4 or 8 ohm loudspeakers

TAPE, TUNER, TV, DVD and CD2 inputs accept high level program source signals

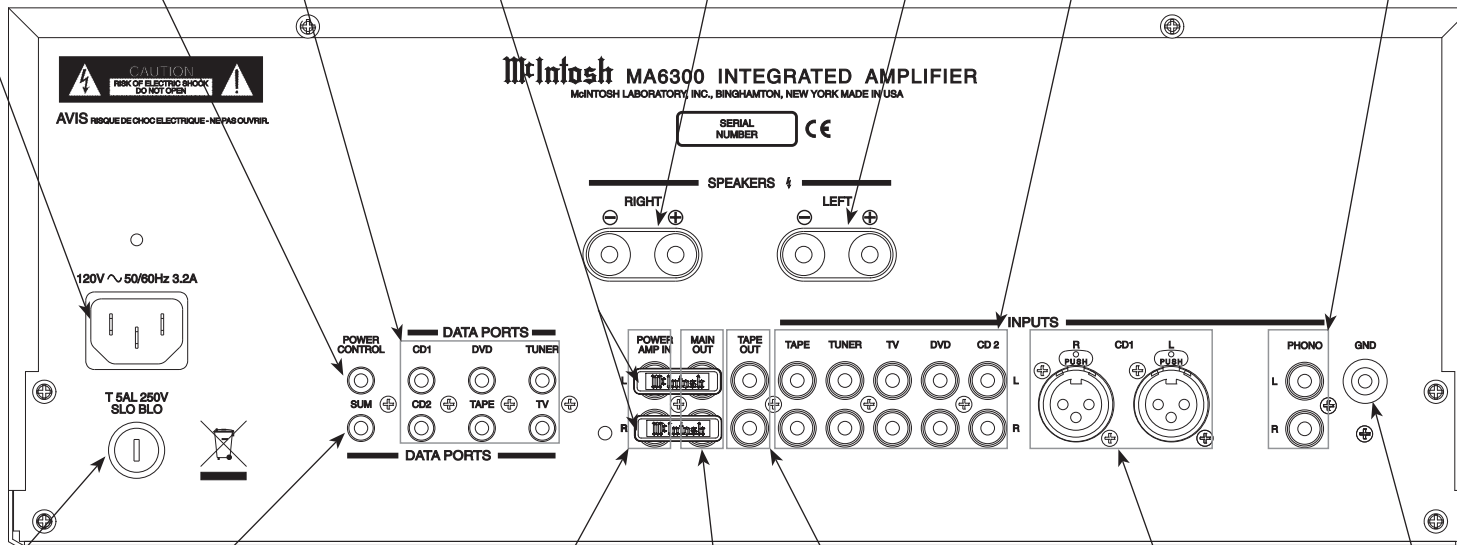

Main Fuse holder, refer to information on the back panel of your MA6300 to determine the correct fuse size and rating

SUM DATA PORT sends data signals from all the Data Ports to McIntosh Source Components for control with the MA6300 Remote Control

POWER AMP IN inputs accept signals from a separate external Preamp

MAIN OUT sends signals to a separate external Power Amplifier

TAPE OUT sends signals to the input of a recording device

CD1 balanced INPUTS accept high level program source signals

GND terminal accepts a ground wire from a turntable



How to Connect Power and Data Control

The MA6300 has the ability to automatically switch power On/Off to McIntosh Source Components via the Power Control connections. The Data Port Connections allow for the remote operation of basic functions using the MA6300 Remote Control. For additional information refer to “Connector and Cable Information” on page 4.

1. Connect a Control Cable from the MA6300 POWER CONTROL Jack to the Power Control In on the McIntosh SACD/CD Player.
2. Connect a Control Cable from the McIntosh SACD/CD Player Power Control Out Jack to the Power Control In jack on the McIntosh Tuner.
3. Connect a Control Cable from the MA6300 CD1 DATA PORTS Jack to the McIntosh SACD/CD Player Data In Jack.

Note: If the CD2 unbalanced Audio Inputs are used instead of the Balanced CD1 Inputs, then connect the Control Cable to the CD2 Data Port.

4. Connect a Control Cable from the MA6300 TUNER DATA PORT Jack to the McIntosh Tuner Data In (Tuner 1).
5. Connect any remaining McIntosh Source Components in a similar manner.

Note: With the addition of a McIntosh Power Controller and Remote Control Translator connected to the MA6300, any McIntosh Classic Components and/or non McIntosh Components connected to the MA6300 can be operated more conveniently. Contact your McIntosh Dealer for additional information.

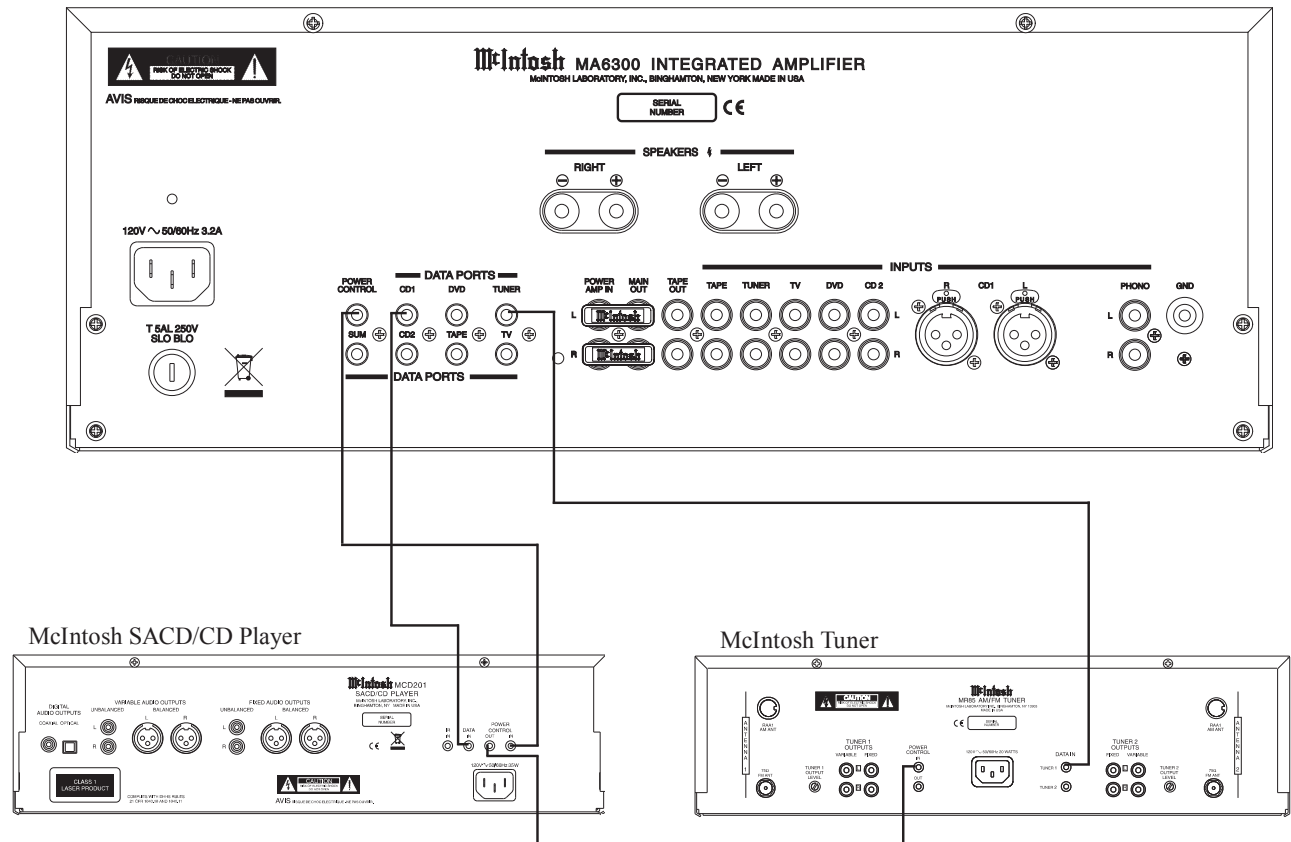

How to Connect Audio Components

1. Connect a Balanced Audio Cable from the McIntosh SACD/CD Player Audio Outputs to the MA6300 CD1 INPUTS.

Note: The unbalanced Audio Outputs from the McIntosh CD Player connected to the CD2 INPUTS may be used instead of the Balanced CD1 Inputs.

2. Connect an Audio Cable from a McIntosh Tuner 1 Fixed Outputs to the MA6300 TUNER INPUTS.
3. Connect an Audio Cable from a Turntable to the PHONO INPUTS and the Turntable Ground Connection to the GND grounding post.
4. Connect an Audio Cable from the MA6300 TAPE OUTS to the Record Inputs of a Recorder and from the MA6300 TAPE INPUTS to the Recorder Outputs.
5. Connect any remaining Source Components in a similar manner.

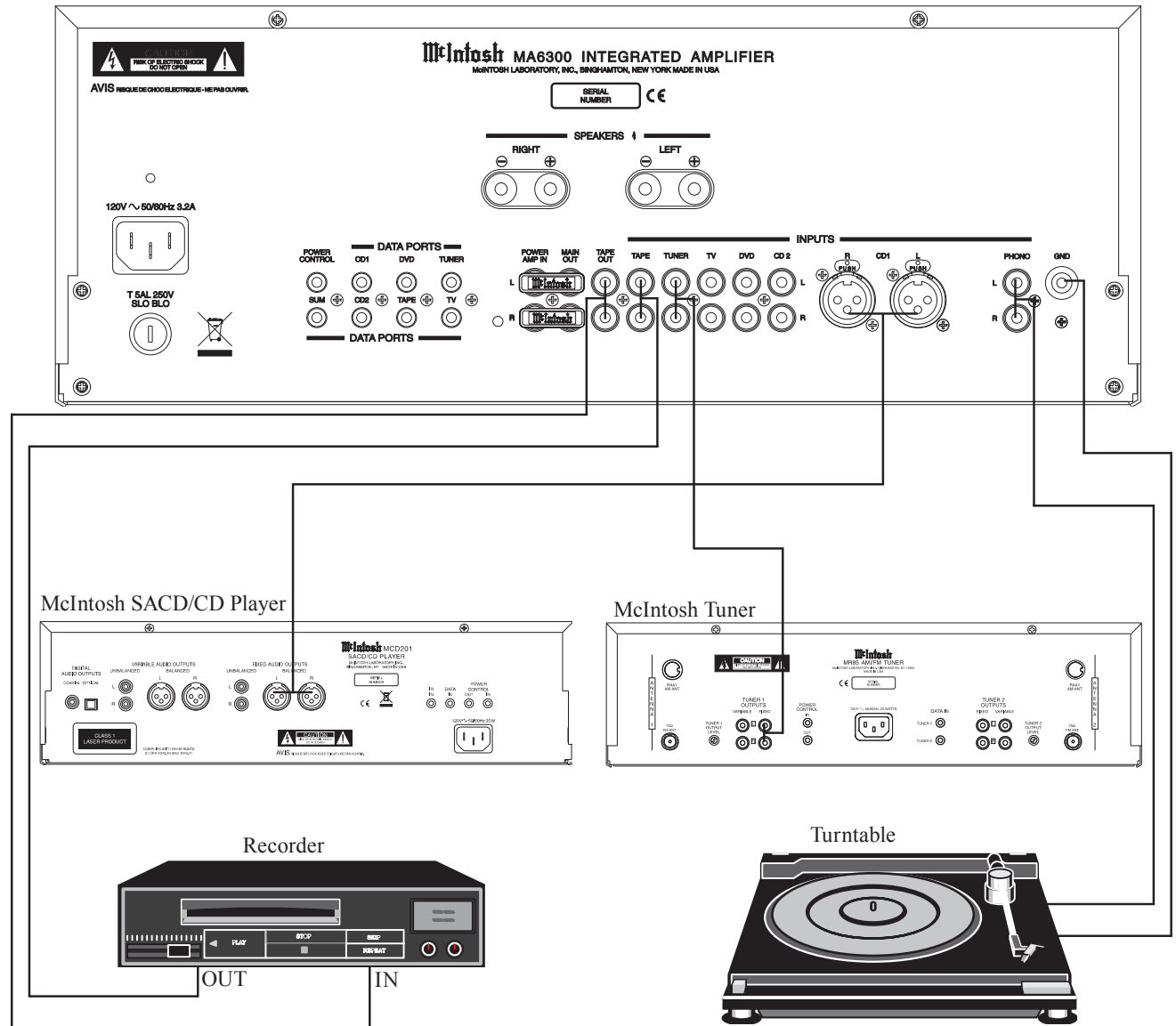

Connecting Loudspeakers

Caution: *The supplied AC Power Cord should not be connected to the Rear Panel of the MA6300 Amplifier until after the Loudspeaker Connections have been made. Failure to observe this could result in Electric Shock. For additional instruction on making Loudspeaker Connections contact your McIntosh Dealer or McIntosh Technical Support.*

When connecting Loudspeakers to the MA6300 it is very important to use cables of adequate size, so there is little to no power loss in the cables. The size is specified in Gauge Numbers or AWG (American Wire Gauge). The smaller the Gauge number, the larger the wire size:

Loudspeaker Cable Distance vs Wire Gauge Guide			
Loudspeaker Impedance	25 feet (7.62 meters) or less	50 feet (15.24 meters) or less	100 feet (30.48 meters) or less
8 Ohms	16AWG	14AWG	12AWG

1. Prepare the Loudspeaker Hookup Cables that attach to the Amplifier by choosing one of the methods below:

Bare wire cable ends:

Carefully remove sufficient insulation from the cable ends, refer to figures 1, 2 & 3. If the cable is stranded, carefully twist the strands together as tightly as possible.

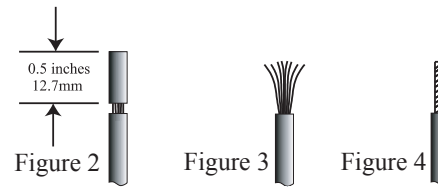

Note: If desired, the twisted ends can be tinned with solder to keep the strands together, or attach spade lug and/or banana connector.

Spade lug or prepared wire connection:

Insert the spade lug connector or prepared section of the cable end into the terminal side access hole, and tighten the terminal cap until the cable is firmly clamped into the terminal so the wires cannot slip out. Refer to figures 4, 5 & 6.

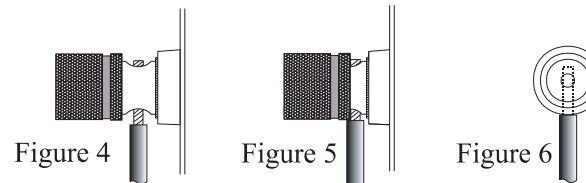

Banana plug connection:

Insert the banana plug into the hole at the top of the terminal. Refer to figure 7.

Note: Banana Plugs are for use in the United States and Canada only.

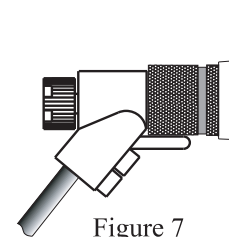

2. Connect the loudspeaker hookup cables to the output terminals that match the impedance of your loudspeakers, being careful to observe the correct polarities.
3. Connect the MA6300 Power Cord to a live AC outlet.

McIntosh Loudspeaker

McIntosh Loudspeaker

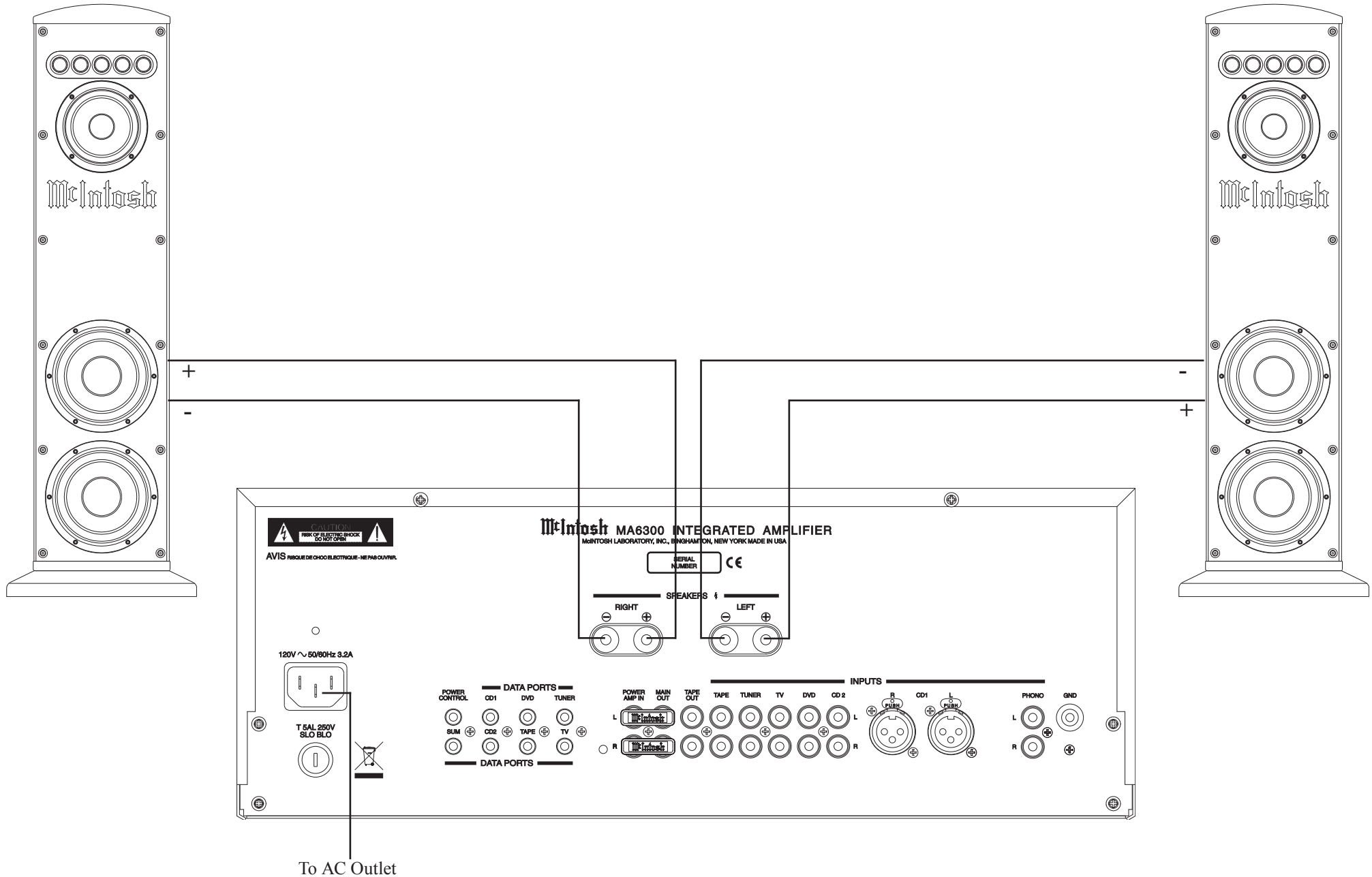



How to Connect an external Power Amplifier

The MA6300 has the ability to be connected to an external Preamplifier and/or Power Amplifier. In the example below, the MA6300 is connected to an external McIntosh Power Amplifier and to a McIntosh Loudspeaker with Bi-amplifier connections. The MA6300 Power Amplifier drives the Midrange/High Frequency Section and the external Power Amplifier drives the Low Frequency Section of the Loudspeaker.

1. Remove the McIntosh Jumpers connected between the MAIN OUT and POWER AMP IN Jacks. Retain them for future use.
2. Connect a pair of “Y” jumper adapters between the MAIN OUT and POWER AMP IN Jacks.
3. Connect an Audio Cable from the just installed “Y” jumper adapters to the unbalanced input jacks on the external McIntosh Power Amplifier.
4. Connect a Control Cable from the MA6300 POWER CONTROL Jack to the Power Control In on the McIntosh Power Amplifier.
5. Using the same Loudspeaker connection methods outlined on page 10, connect the MA6300 SPEAKER Connections to the Midrange/High Frequency Loudspeaker Connections. Connect the external Power Amplifier LEFT and RIGHT OUTPUT Connections to the Loudspeaker Low Frequency Connections.
6. Connect the MA6300 Power Cord to a live AC outlet.

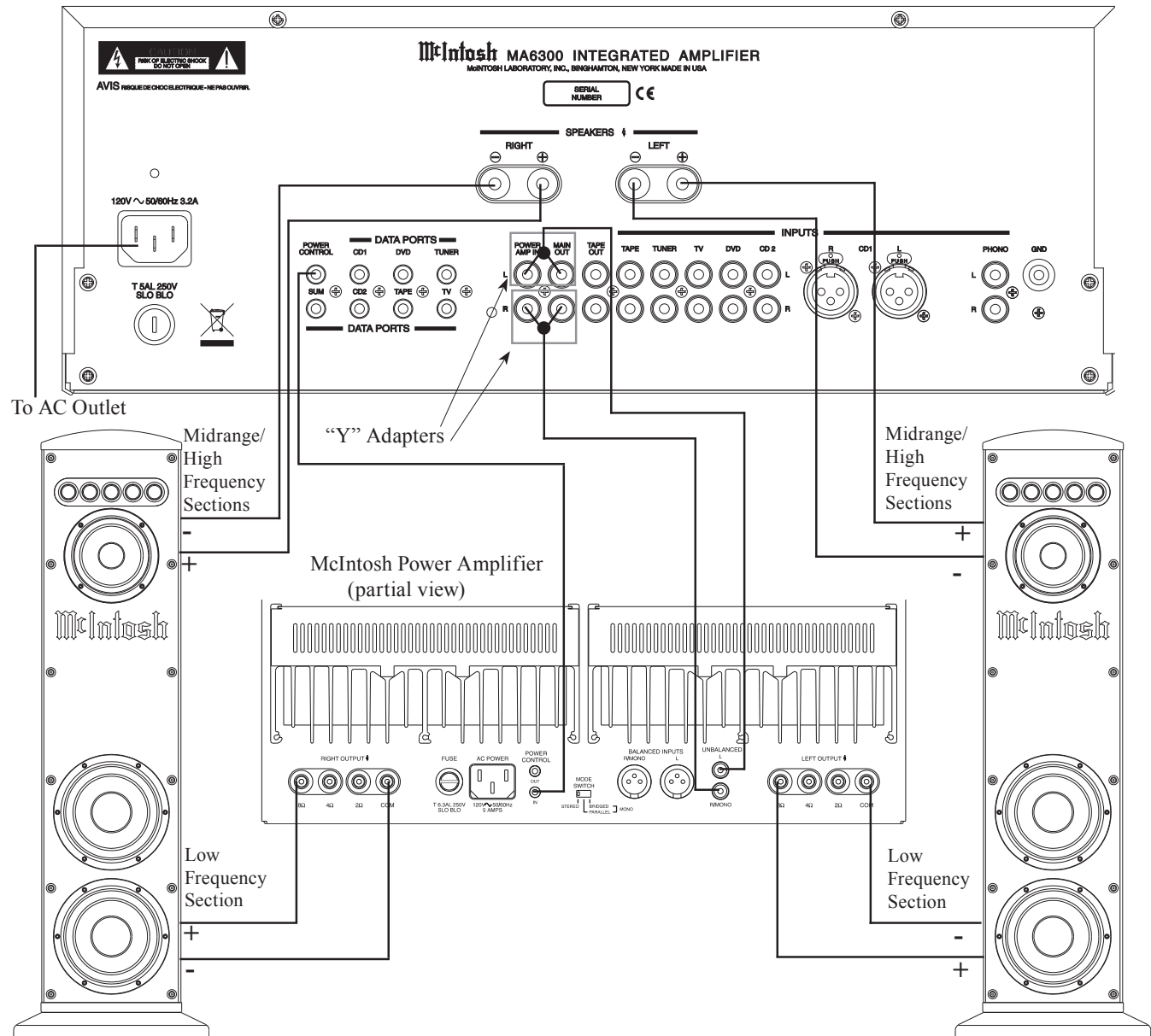

Front Panel Displays, Controls, Push-buttons and Jack

Meter indicates the Left Channel Output of the amplifier

LED indicates when the Left Channel Amplifier POWER GUARD circuit activates

LED indicates when the Right Channel Amplifier POWER GUARD circuit activates

Indicates the Audio Output is Muted

Standby Power On Indicator

The LEDs above the push-buttons indicate the current source selected.

IR Sensor receives commands from a Remote Control

Indicates the MONO Mode is active

Meter indicates the Right Channel Output of the amplifier

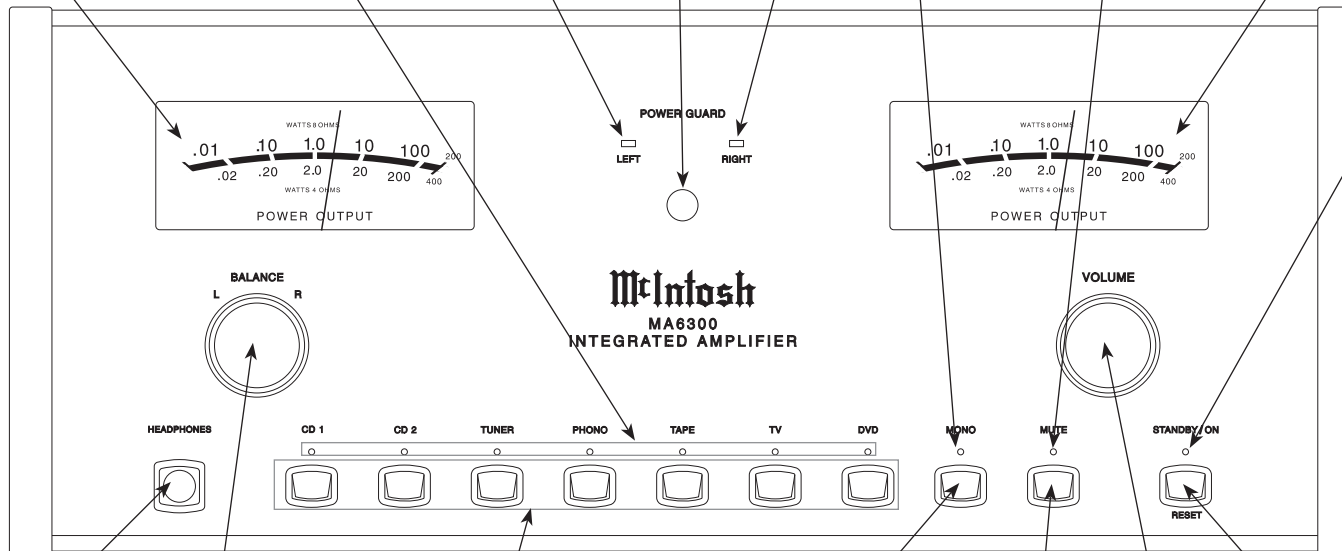

Connection for low impedance dynamic headphones, for private listening

BALANCE Control allows adjustment of the relative volume balance between channels

Source Push-buttons select audio signals from seven inputs for listening

MONO Push-button combines the Left and Right Channel signals for Monophonic Sound

Push to mute the audio from the Loudspeakers (Headphones are not affected)

VOLUME Control allows adjustment of the listening level for both channels

STANDBY/ON Push-button switches the MA6300 ON or OFF (Standby) and resets the microprocessors



How to Operate the MA6300

Power On

The Red LED above the STANDBY/ON Push-button lights to indicate the MA6300 is in Standby mode. To Switch ON the MA6300, press the STANDBY/ON Push-button on the Front Panel or the  (Power) Push-button on the Remote Control. The MUTE LED will light for approximately two seconds after turn on. Refer to figures 8 and 9.

Source Selection

Select the desired source with the appropriate push-button switch on the Front Panel or Remote Control.

Volume Control

Rotate the Front Panel VOLUME Control or use the VOLume + or - Push-button on the Remote Control for the desired listening level.

Balance Control

Rotate the Front Panel BALANCE Control as needed to achieve approximately equal listening volume levels in each Loudspeaker. Rotate the BALANCE counter-clockwise to emphasize the Left Channel by reducing the level of the Right Channel. Rotate the BALANCE clockwise to emphasize the Right Channel by reducing the level of the Left Channel.

Mono

Press the Front Panel MONO Push-button or the MODE Push-button on the Remote Control to combine left and right stereo signals to a Monophonic signal.

Note: The signals at the TAPE OUT Jacks are not affected.

Mute

Press the MUTE Push-button on the Front Panel or

Remote Control to mute the audio in all outputs except the HEADPHONES and TAPE OUTPUT. The MUTE LED above the push-button flashes to indicate that Mute is active. To un-mute the audio, press MUTE Push-button again, press the Remote Control Volume Push-button(s) or press a Source Push-button.

Headphones Jack

Connect a pair of dynamic headphones to the Headphones Jack for private listening. Press the MUTE Push-button to mute the Loudspeakers.

Note: The Headphone Output is optimized for impedances ranging from 16 to 250 ohms.

Power Output Meters

The MA6300 Power Output Meters indicate the power delivered to the Loudspeakers. The meters respond to all the musical information being produced by the Amplifier. They indicate to an accuracy of at least 95% of the power output with only a single cycle of a 2,000Hz tone burst. Read the Upper Meter Scale if the Loudspeakers connected to the MA6300 are of 8 Ohm Impedance and the Lower Meter Scale if they are 4 Ohms.

Power Guard

During normal operation, the Front Panel Power Guard Indicators will momentarily illuminate during peaks in the audio signals. In the event the MA6300 overheats, due to improper ventilation and/or high ambient temperature, the internal protection circuits will activate. The Front Panel Power Guard Indicators will continuously illuminate and the audio will be muted.

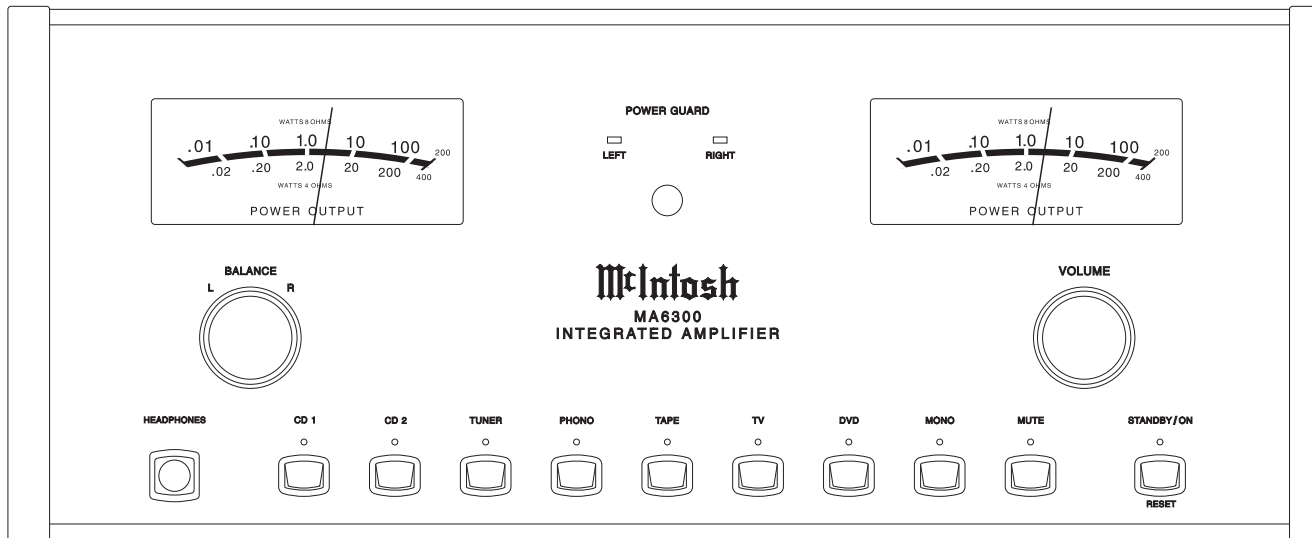

Figure 8

When the MA6300 has returned to a safe operating temperature, normal operation will resume.

How To Make A Tape Recording

1. Select the signal you wish to record with the appropriate Source Push-button.
2. Adjust the record level using the recorder volume control and proceed with the recording process.
3. To listen to the playback of the program source just recorded, press the TAPE Push-button.

Note: The MA6300 TAPE OUTPUTS are not affected by the VOLUME or BALANCE controls.

Reset of Microprocessors

In the unlikely event the controls of the MA6300 stop functioning, the microprocessors can be reset by performing the following:

1. Press and hold in the STANDBY/ON Push-button for approximately five seconds.
2. When the MA6300 cycles On then Off, release the STANDBY/ON Push-button.
3. When the STANDBY/ON LED is illuminated press the STANDBY/ON Push-button, the MA6300 will resume normal operation.

Note: This can be performed with the MA6300 On or in the Standby Mode.

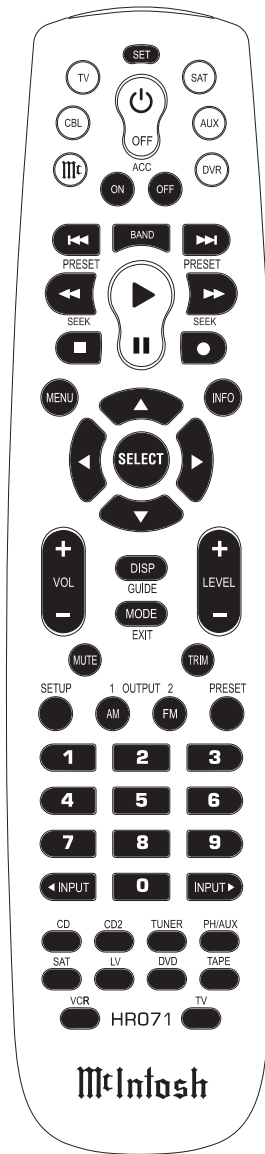
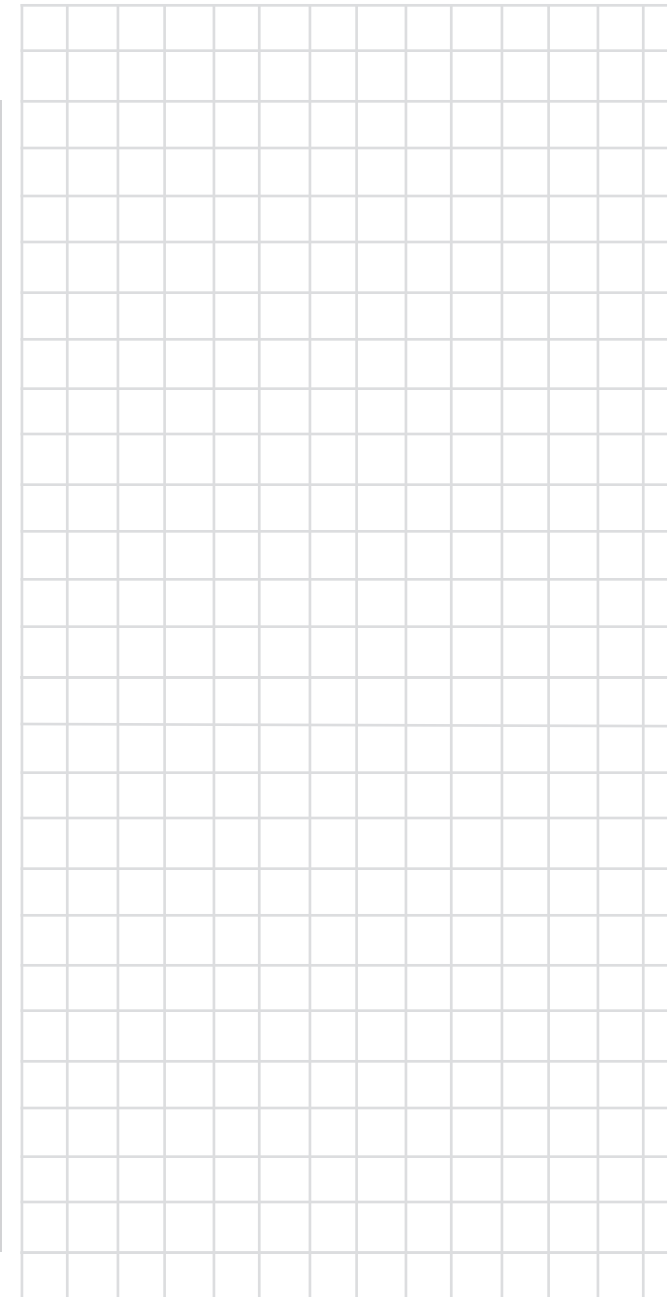

Figure 9

Note: For an explanation of the Remote Control Push-button functions, refer to pages 16 and 17.



LED illuminates during the time a remote command is sent to the MA6300

Turns AC Power ON or OFF to certain McIntosh Components when connected via the Data Port

Selects a Disc Player, Music Server or Recorder Function. Seek Stations Up or Down the AM/FM Dial. Select AM/FM Station Presets and performs various functions on a variety of McIntosh Components

Displays On Screen Functions on the McIntosh Music Server and a variety of other McIntosh Components

Adjusts the volume level up or down

Press MODE to switch between Stereo and Mono Modes. Also allows exiting out of the setup mode.

Mutes the audio

Selects AM Tuner Operating Functions and Disc Selection on certain McIntosh Disc Players

Selects Functions as a “shift” key when used with the AM or FM push-buttons to select Output 1 or 2

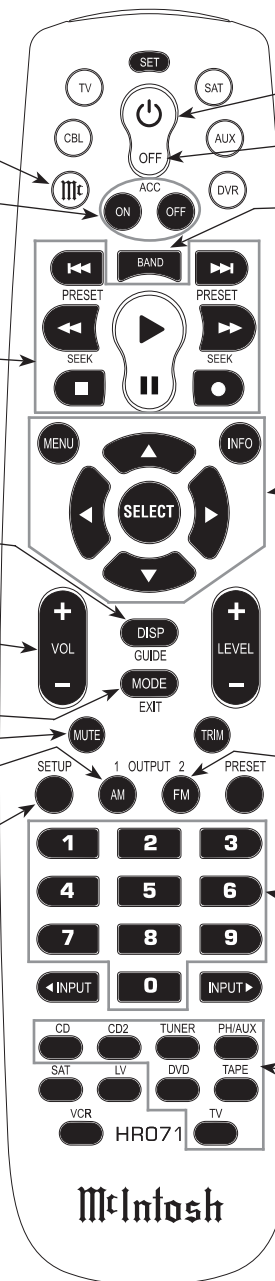

Press to Power the MA6300 ON

Press to Power the MA6300 OFF

Press to select certain functions of a McIntosh Tuner connected to the MA6300

Selects On Screen Functions on a variety of McIntosh Components

Selects FM Tuner Operating Functions or Track Selection on certain McIntosh CD Players

Use to select tuner presets, disc tracks or any numbered operation

Selects one of the seven available Audio Sources

Note: Push-buttons whose function is not identified above are for use with other McIntosh Products.

How to use the Remote Control

The supplied HRO71 Remote Control is capable of directly controlling the functions of contemporary McIntosh Source Components connected to the MA6300 via the Data Ports.

Note: If at any time the MA6300 seems unresponsive to HRO70 Remote Control Commands press the  Push-button first.

Input Source Selection

Press the appropriate Source Push-button to select the desired program source.

Mute

Press the MUTE Push-button to mute the audio in all outputs except the HEADPHONES and TAPE OUTPUT. The MUTE LED above the push-button will flash on and off to indicate that Mute is active. To unmute the audio, press MUTE Push-button again.

Mono

Press the MONO Push-button to switch from Stereo to Mono for Monophonic listening.

Disc, Server and Tape Functions

Use these push-buttons to operate a DVD Player, CD Player, CD Changer, Music Server or Recorder.





Numbered Push-buttons

Press Push-buttons 0 through 9 to access tuner station presets, tracks on discs or selections on a Music Server.

Disc and Track

Use the AM(disc)and FM(track)Push-buttons when a Disc Player or Music Server is being used.

Tuner Push-buttons

Press the AM or FM Push-button to select the desired broadcast band. Press and release the Seek  or Seek  Push-button to seek the next available station. Press and hold a Seek  or Seek  Push-button to seek continuously from station to station.

Band

Depending on the McIntosh Tuner connected to the MA6300, pressing the BAND Push-button will either review Tuner Station Presets or switch between available Radio Station Tuning Bands.

Volume

Press the VOLUME + or - Push-button to raise or lower the listening volume level.

Note: The Record Signals present at REC OUTPUTS are not affected by volume changes.

Pause

Press the Pause  Pushbutton to perform various functions on a variety of McIntosh Components. It will also pause the playing of a disc or tape player.

Acc On/Off

Press ACC ON to turn the power ON or ACC OFF switches AC Power OFF to McIntosh Components when connected to the ACC Power Control Jack.



Specifications

Power Output

100 watts into an 8 ohm load is the minimum sine wave continuous average power output. The output RMS voltage is 28.3V across 8 ohms

160 watts into a 4 ohm load is the minimum sine wave continuous average power output. The output RMS voltage is 25.3V across 4 ohms

Output Load Impedance

8 and 4 ohms

Rated Power Band

20Hz to 20,000Hz

Total Harmonic Distortion

0.005% maximum harmonic distortion at any power level from 250 milliwatts to rated power, 20Hz to 20,000Hz

Dynamic Headroom

1.4dB

Frequency Response

+0, -0.5dB from 20Hz to 20,000Hz

+0, -3dB from 10Hz to 100,000Hz

Preamplifier Main Output

1V for rated input (8V Maximum)

Sensitivity (for rated output)

High Level, 250mV unbalanced, 500mV balanced

Phono, 2.5mV

Power Amp In, 1V

Signal To Noise Ratio (A-Weighted)

High Level, 97dB below rated output

Phono, 90dB below 10mV input

Power Amplifier, 110 below rated output

Intermodulation Distortion

0.005% maximum, if the instantaneous peak power output is rated power or less per channel with both channels operating for any combination of frequencies from 20Hz to 20,000Hz.

Wide Band Damping Factor

200 at 8 ohms

100 at 4 ohms

Input Impedance

High Level, 20K ohms

Phono, 47K ohms; 65pF

Power Amp In, 10K ohms

Maximum Input Signal

High Level, 8V

Phono, 90mV

Power Amplifier In, 8V

Main Output Impedance

50 ohms

Power Guard

Less than 2% THD with up to 16dB overdrive at

1,000Hz

Voltage Gain

High Level to Tape Output: 0dB

High Level to Main Output: 12dB

Phono to Main Output: 52dB

Power Requirements

100 Volts, 50/60Hz at 3.6 amps

110 Volts, 50/60Hz at 3.6 amps

120 Volts, 50/60Hz at 3.2 amps

220 Volts, 50/60Hz at 1.8 amps

230 Volts, 50/60Hz at 1.8 amps

240 Volts, 50/60Hz at 1.8 amps

Note: Refer to the rear panel of the MA6300 for the correct voltage.

Overall Dimensions

Width is 17-1/2 inches (44.45cm)

Height is 7-5/8 inches (19.37cm) including feet

Depth is 22 inches (55.88cm) including the Front Panel, Knobs and Cables

Weight

37 pounds (16.8 kg) net, 55 pounds (24.9 kg) in shipping carton

Shipping Carton Dimensions

Width is 25 inches (63.5cm)

Depth is 27 inches (68.6cm)

Height is 12 inches (30.5cm)

Packing Instructions

In the event it is necessary to repack the equipment for shipment, the equipment must be packed exactly as shown below. It is very important that the four plastic feet are attached to the bottom of the equipment.

This will ensure the proper equipment location on the bottom pad. Failure to do this will result in shipping damage.

Use the original shipping carton and interior parts only if they are all in good serviceable condition. If a shipping carton or any of the interior part(s) are needed, please call or write Customer Service Department of McIntosh Laboratory. Refer to page 3. Please see the Part List for the correct part numbers.

Quantity	Part Number	Description
1	033888	Shipping carton only
4	033887	End cap
1	033697	Inside carton only
1	033725	Top pad
1	034301	Bottom pad
1	033699	Shipping skid
2	017218	Plastic foot spacers
2	101204	#10 x 2-1/4" wood screws
2	104033	#10 x 1-3/4" flat washer
4	017937	Plastic foot
4	100159	#10-32 x 3/4" screw
4	104083	#10-7/16" Flat washer

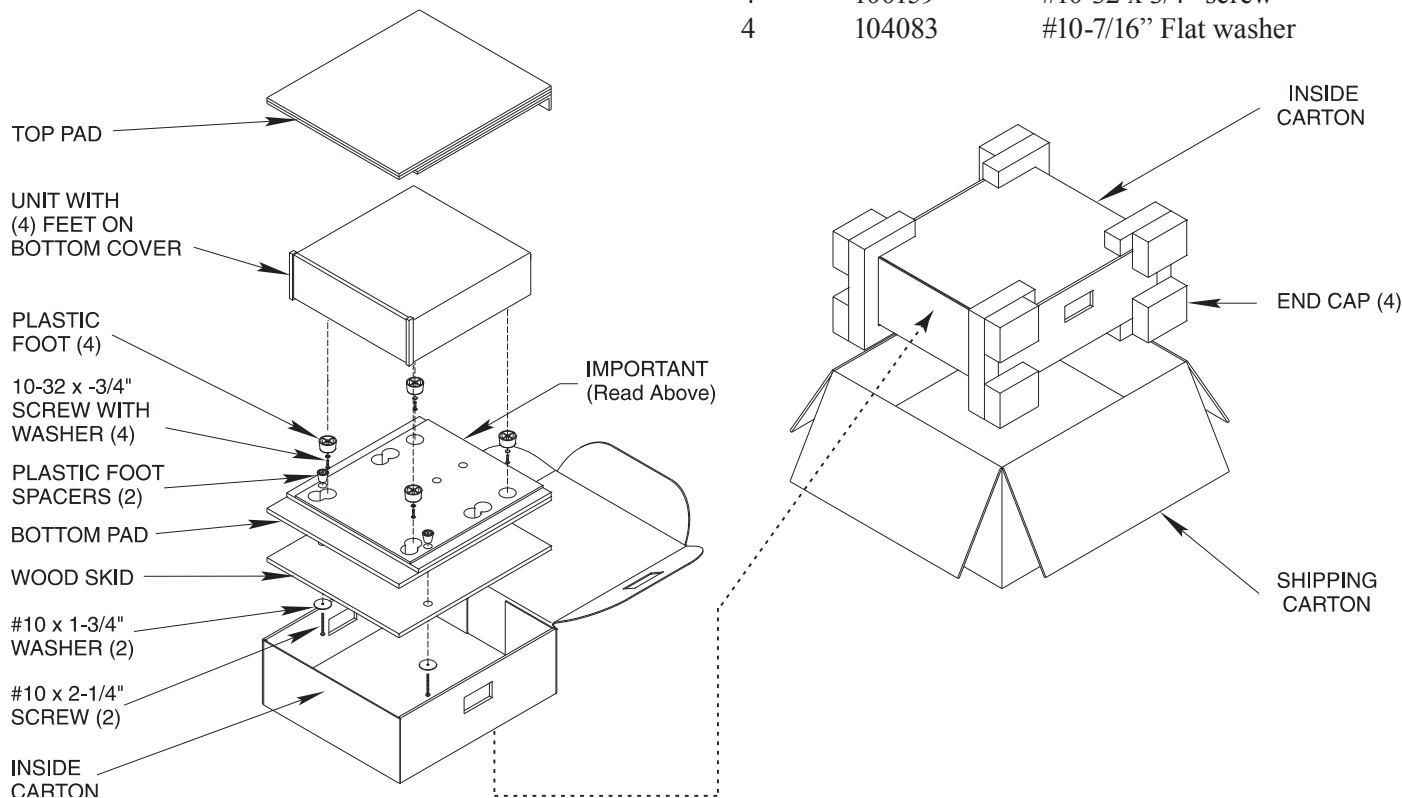



McIntosh Laboratory, Inc.
2 Chambers Street
Binghamton, NY 13903
www.mcintoshlabs.com

The continuous improvement of its products is the policy of McIntosh Laboratory Incorporated who reserve the right to improve design without notice.
Printed in the U.S.A.