



McIntosh Laboratory, Inc. 2 Chambers Street Binghamton, New York 13903-2699 Phone: 607-723-3512 [www.mcintoshlabs.com](http://www.mcintoshlabs.com)

---

MT2

Precision Turntable

Owner's Manual





**Important Safety Information is supplied in a separate document “Important Additional Operation Information Guide”**

**Thank You**

Your decision to own this McIntosh MT2 Turntable ranks you at the very top among discriminating music listeners. You now have “The Best.” The McIntosh dedication to “Quality,” is assurance that you will receive many years of musical enjoyment from this unit. Please take a short time to read the information in this manual. We want you to be as familiar as possible with all the features and functions of your new McIntosh.

**Please Take A Moment**

The serial number, purchase date and McIntosh Dealer name are important to you for possible insurance claim or future service. The spaces below have been provided for you to record that information:

Serial Number: \_\_\_\_\_

Purchase Date: \_\_\_\_\_

Dealer Name: \_\_\_\_\_

**Technical Assistance**

If at any time you have questions about your McIntosh product, contact your McIntosh Dealer who is familiar with your McIntosh equipment and any other brands that may be part of your system. If you or your Dealer wish additional help concerning a suspected problem, you can receive technical assistance for all McIntosh products at:

McIntosh Laboratory, Inc.  
2 Chambers Street  
Binghamton, New York 13903  
Phone: 607-723-3512  
Fax: 607-724-0549

**Customer Service**

If it is determined that your McIntosh product is in need of repair, you can return it to your Dealer. You can also return it to the McIntosh Laboratory Service Department. For assistance on factory repair return procedure, contact the McIntosh Service Department at:

McIntosh Laboratory, Inc.  
2 Chambers Street  
Binghamton, New York 13903  
Phone: 607-723-3515  
Fax: 607-723-1917

**Table of Contents**

|   |                                    |
|---|------------------------------------|
| Safety Instructions .....   | 2                                  |
| (Separate Sheet) .....  | <b>Important Additional</b>        |
|   | <b>Operation Information Guide</b> |
| Thank You and Please Take a Moment.....                               | 2                                  |
| Technical Assistance and Customer Service .....                       | 2                                  |
| General Information .....   | 3                                  |
| Connector and Cable Information .....                                 | 3                                  |
| Introduction.....   | 4                                  |
| Performance Features .....  | 4                                  |
| Dimensions .....  | 5                                  |
| Unpacking the Turntable.....  | 6                                  |
| Assembling the Turntable .....  | 7-9                                |
| Installing a non-supplied Cartridge<br>and Tone Arm Adjustments ..... | 10-12                              |
| Trackability Adjustments.....   | 12                                 |
| Rear Panel Connections and Adjustments .....                          | 13                                 |
| How to Connect the Turntable.....                                     | 14                                 |
| Switches, Lever and Record Clamp.....                                 | 15                                 |
| How to Operate the Turntable.....                                     | 16                                 |
| Photo .....   | 17                                 |
| Specifications.....   | 18                                 |
| Packing Instructions .....  | 19                                 |

## General Information

**Caution:** To prevent possible damage to the turntable platter bearing, do not transport the MT2 Precision Turntable with the platter installed.

1. For additional connection information, refer to the owner's manual(s) for any component(s) connected to the MT2 Precision Turntable.
2. The MT2 Precision Turntable comes with the Sumiko Moonstone Moving Magnet Cartridge.
3. It is recommended the Professionals at your McIntosh Dealer, who are skilled in all aspects of Turntables and Phono Cartridges, install the MT2 Precision Turntable and any associated audio equipment.
4. For optimum performance, the setup and adjustment of the MT2 Precision Turntable requires special test recordings and test/measurement equipment. Contact your McIntosh Dealer for additional information and assistance.
5. The MT2 Precision Turntable is supplied with the Sumiko Moonstone Moving Magnet Cartridge. The Sumiko Moonstone output level is compatible with the MM (Moving Magnet) Input on McIntosh Pre-amplifiers, Integrated Amplifiers and A/V Control Center. It is designed to playback 33-1/3 rpm and 45 rpm vinyl recordings. Contact your McIntosh Dealer for additional information and assistance.
6. When discarding the unit, comply with local rules or regulations. Batteries should never be thrown away or incinerated but disposed of in accordance with the local regulations concerning battery disposal. 
7. For additional information on the MT2 and other McIntosh Products please visit the McIntosh Web Site at [www.mcintoshlabs.com](http://www.mcintoshlabs.com).
8. When an AC Line Cord is used to connect the

- supplied AC / DC Adapter to an AC Outlet, it is important the line cord conductor size is a minimum 0.75mm<sup>2</sup> for each leg of the two conductor cord.
9. If it should become necessary to replace the supplied AC / DC Adapter and/or the plug adapters, order part number 310693SP from the McIntosh Parts Department. Refer to the illustration below.



## Phono Cartridge Connection Information

### Tonearm Headshell Wiring

Refer to the following list of wire colors in the headshell for installing the cartridge into the Headshell:

| Cartridge Connections | Headshell Wire Color |
|-----------------------|----------------------|
| Left Channel (+)      | White                |
| Left Channel (-)      | Blue                 |
| Right Channel (+)     | Red                  |
| Right Channel (-)     | Green                |

### Sumiko Moonstone Cartridge Connections

Refer to the following illustration when connecting the McIntosh Cartridge in the Headshell:

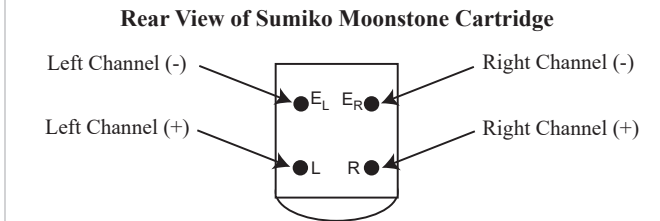



### Introduction

The McIntosh MT2 Precision Turntable with the Sumiko Moonstone Moving Magnet Cartridge offers the latest in playback of vinyl recordings. A full complement of performance features allows for the enjoyment of all recordings reproduced with flawless realism. The advanced electronic and mechanical design ensures many years of smooth trouble free operation.

### Performance Features

#### • **Advanced Technology Turntable**

The MT2 combines the latest technology in Phono Cartridges, Tone Arms, Mechanical Suspensions and Record Platter Rotation for superb performance and accurate operation.

#### • **Moving Magnet Cartridge**

The Sumiko Moonstone Moving Magnet Cartridge uses only the finest quality high purity copper wire, and together with its higher output ensures low noise, high resolution music playback. This features an alloy cantilever, elliptical diamond stylus with exceptional tracking capability. The ruler-flat frequency response from 20Hz to 20kHz provides solid realistic bass, uncolored midrange and natural high frequencies.

#### • **Tone Arm**

The MT2 tonearm is made from dural aluminium with special damping material. The tonearm is both light in weight and highly rigid. The noise free vertical bearings are made from two high precision ceramic surfaces with damping fluid. The horizontal bearing is a gimbaled sapphire design.

#### • **Turntable Platters**

The full size outer platter is made from a special dynamically balanced polyoxymethylene (POM), weighs 5.07 pounds, 1.18 inches thick. This helps to resist and absorb external vibrations from reaching the record during playback and its large mass provides the perfect flywheel action for stable playback speed. The inner platter is made of CNC-precision milled aluminium, weighs 0.96 pounds and is six and one quarter inches in diameter.

#### • **Precision Motor and Drive Electronics**

The DC motor is fed by an external voltage-stabilized power supply and is completely decoupled from the chassis, isolating the record from any mechanical interference.

#### • **Two Playback Speeds with fine Adjustments**

The MT2 Turntable has two playback speed, 33 rpm and 45 rpm. There is a separate trim adjustment allowing for accurate music reproduction for each of the two speeds.

#### • **Bearing**

The MT2 Turntable Platter rotates on a Polished and Tempered Steel Shaft in a sintered bronze bushing and is coated with Teflon.

#### • **Multi-Layered Dampened Chassis**

The MT2 Turntable Chassis has a resonance optimized and highly compressed wood chassis with black lacquer. The top and middle plate which is made of acrylic also absorb vibrations.

#### • **Fiber Optic Solid State Illumination**

The even illumination of the top panel and the turntable platter is accomplished by the combination of custom designed fiber optic light diffusers and extra long life light emitting diodes (LEDs).

**Dimensions**

The following dimensions can assist in determining the best location for your MT2.

**Front View of the MT2**

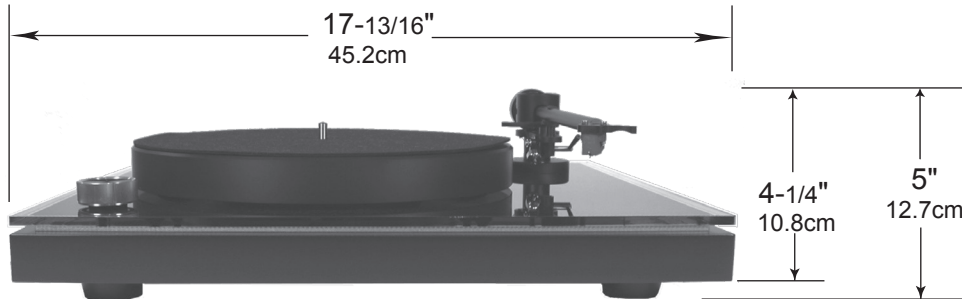

*Note: The height measurements are with the Moonstone Cartridge installed.*

**Rear View of the MT2**

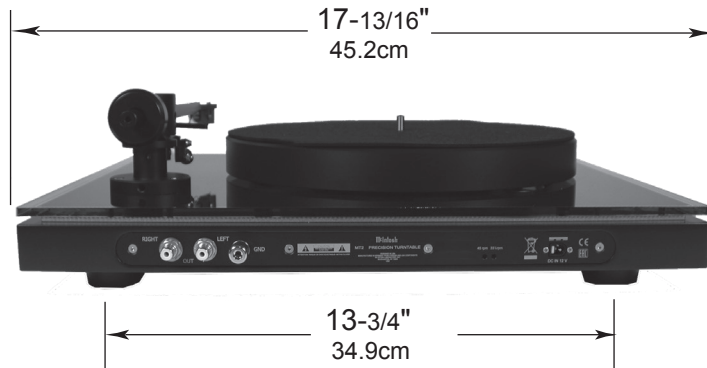

**Side View of the MT2**

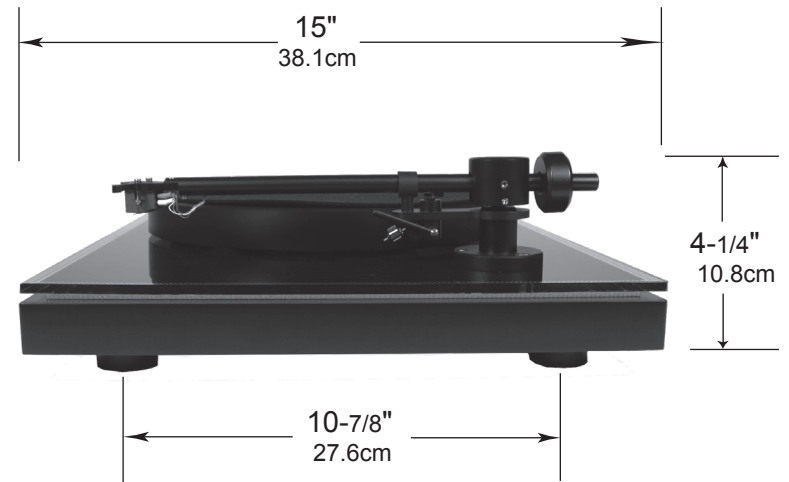

## Unpacking the Turntable

To protect the fine finish of the MT2 Precision Turntable during the assembly and adjustment process, it is advisable to prepare a suitable clean working area with a soft, clean fabric, such as a bed linen or blanket.

It is recommended that the Professionals at your McIntosh Dealer, who are skilled in all aspects of installation and operation, unpack, assemble, adjust and install the MT2 Precision Turntable.

**CAUTION:** *To prevent possible damage to the turntable platter bearing, do not move the MT2 Precision Turntable after the Outer Platter is installed.*

1. Referring to the illustration on the right, open the shipping carton and carefully remove the following items from the carton and place them in the previously prepared working area:

- A. Owner's Manual Pack, Record Mat Tone Arm/Cartridge Alignment Gauge and Pair of Gloves
- B. Dust Cover
- C. Turntable
- D. Outer Platter
- E. Accessories:
  1. Record Clamp
  2. AC/DC Adapter and Plugs
  3. Belt
  4. Grounding Cable
  5. Bearing Oil<sup>1</sup>
  6. Bubble Level
  7. Cartridge Mounting Screws
  8. Tonearm Counter Weight
  9. Screw Driver and Allen Wrenches
  10. Stylus Force Gauge

2. Proceed to Assembly of the Turntable starting on the next page.

**CAUTION:** *To prevent possible damage to the Cartridge Stylus, DO NOT remove the Stylus Guard at this time.*

<sup>1</sup> Some time in the distant future, the inside vertical shaft located below the Inner Platter might require one or two drops of oil.

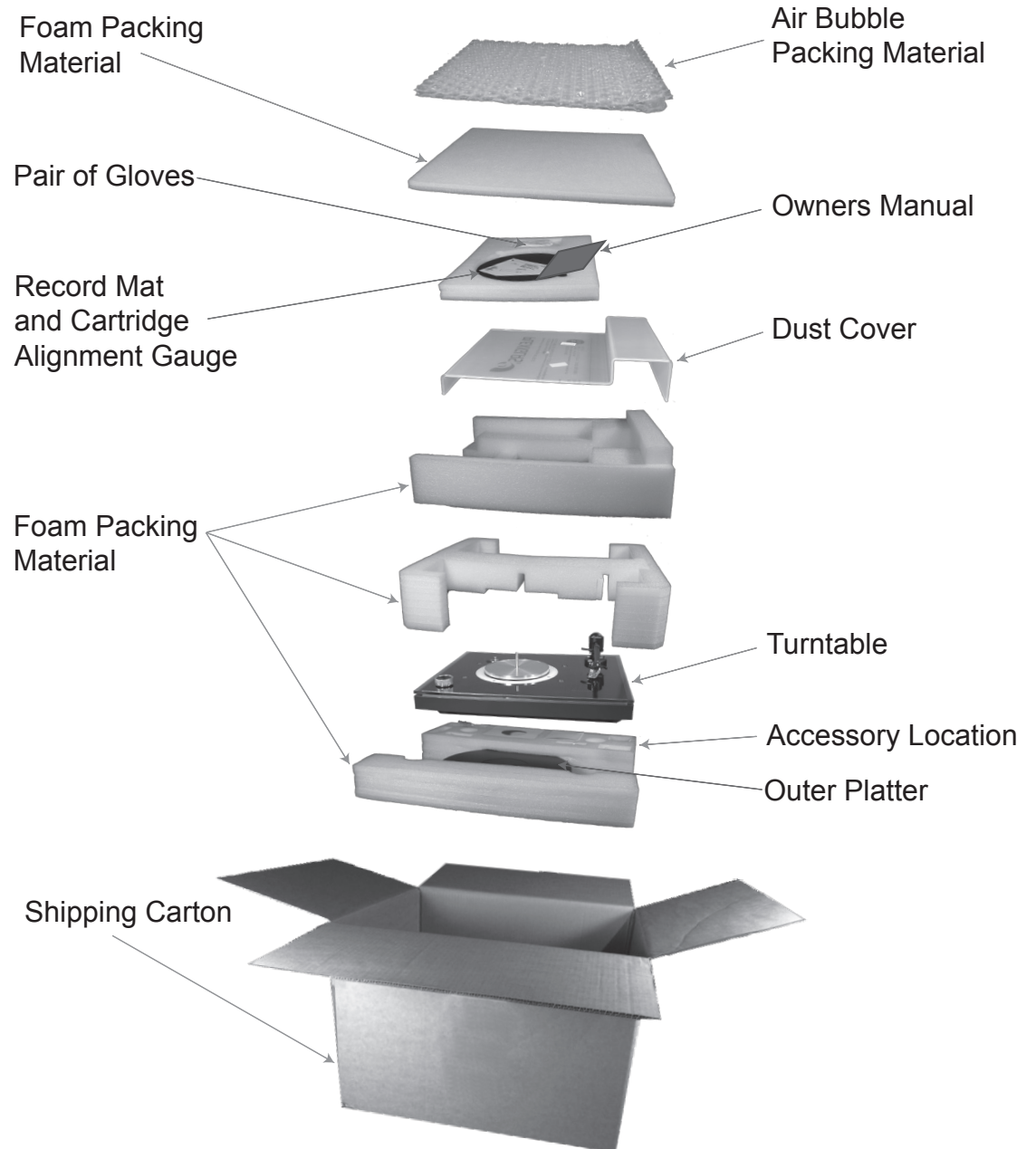

## Assembling the Turntable

Place the Turntable in the location where it will be used. Please keep in mind; the turntable should be the greatest possible distance from the system loudspeakers to reduce the chance of acoustic feedback. To minimize the possibility of the cartridge stylus jumping record grooves, place the turntable on a mechanically stable surface such as wall shelving anchored to wall studs. Perform the following assembly steps:

*Note: It is recommended the installation and adjustment of the McIntosh MT2 Precision Turntable be performed by the Professionals at your McIntosh Dealer.*

1. Remove the protective mesh from the Turntable Vertical Bearing Shaft. Refer to figure 1.

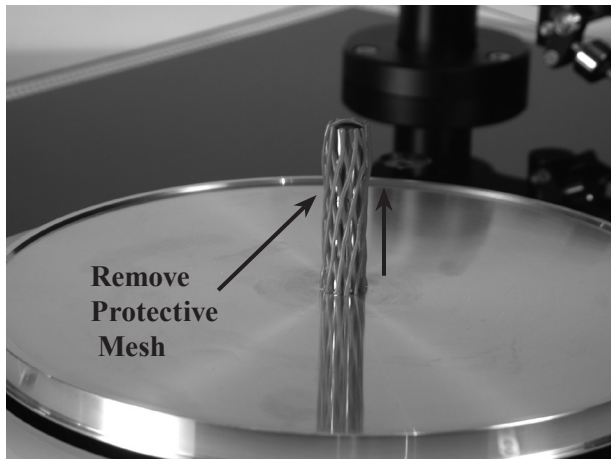

Figure 1

2. Using the supplied cloth gloves, place the belt onto the circumference of the inner platter and then onto the pulley of the motor. Rotate the inner platter by hand while seating the belt into it. Refer to figure 2.

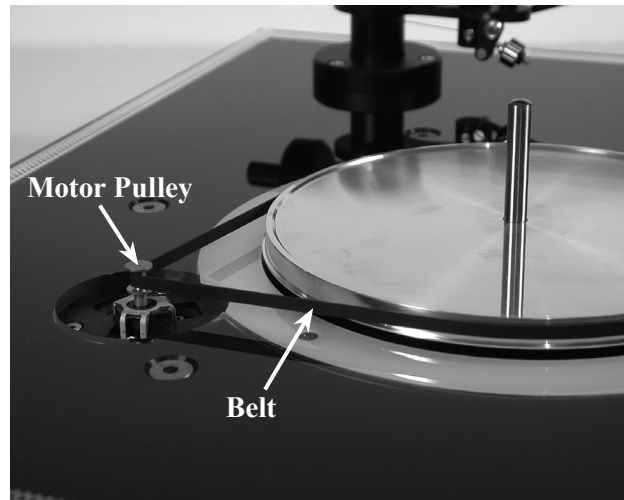

Figure 2

4. Next, take the Outer Platter and slowly lower it onto the Inner Platter making sure to keep the Outer Platter parallel to the Turntable surface as it is being lowered. Refer to figure 3.

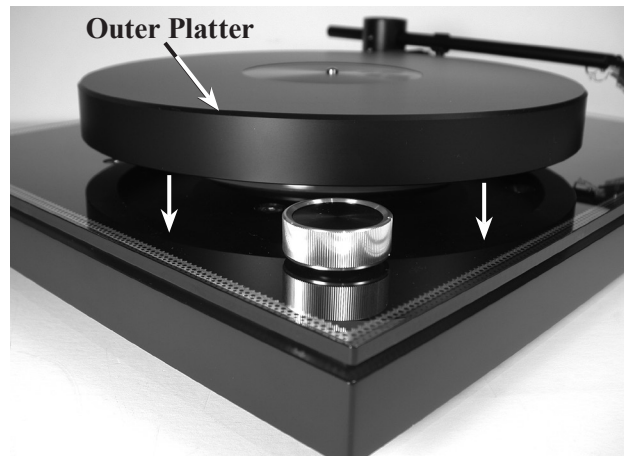

Figure 3

5. Locate the Record Mat and place it on top of the platter. Refer to figure 4.



Figure 4

6. Locate the McIntosh Bubble Level and place it on the Record Mat. Refer to figure 5.

If the Bubble is not in the center circle of the Bubble Level, adjust the height of the Turntable Feet (by rotating them clockwise or counter clockwise) until it is level. Refer to figures 6 and 7 on the next page.

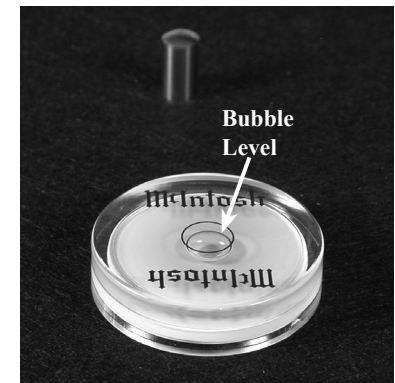

Figure 5

## Assembling the Turntable, con't

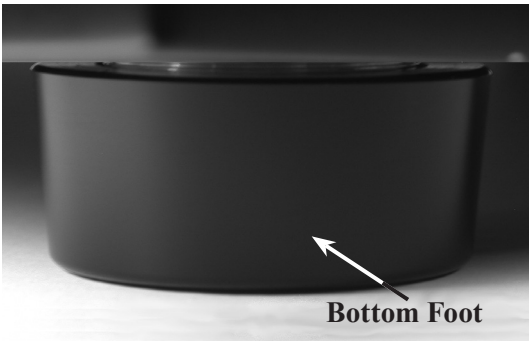

Figure 6

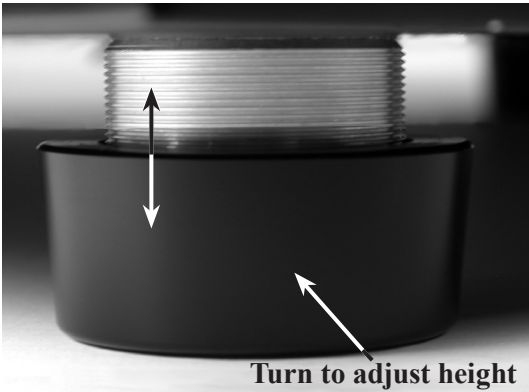

Figure 7

7. Locate the Tone Arm Counterweight and the supplied small bottle of Bearing Oil. Using a small cotton swab (Q-Tip) apply one drop of the oil to the inside center of the Counterweight "O" Rings. Refer to figure 8.



Coat the inside "O" Rings with a drop of oil

Figure 8

8. Align the inside opening of the Counterweight with the rear end of the Tone Arm. Then slowly rotate the Counterweight until the front vertical surface of it lines up with the center of the Counterweight Reference Line. Refer to figures 9, 10 and 11.

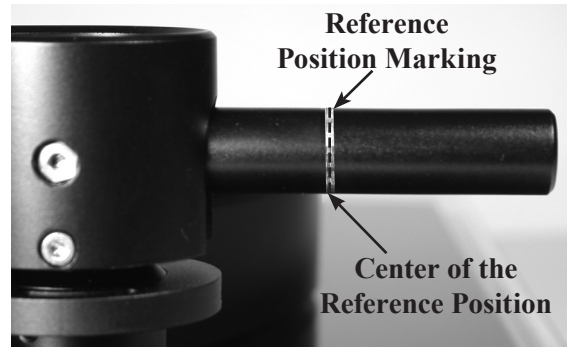

Figure 9

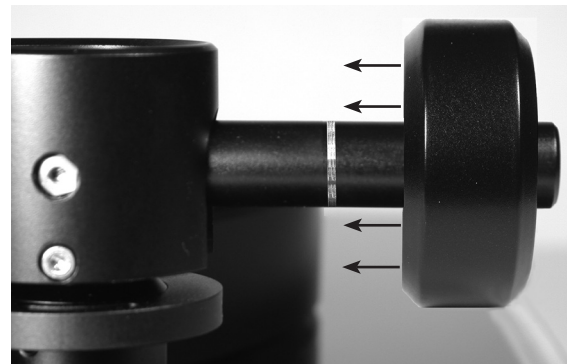

Figure 10

*Note: It is recommended to check the tracking force using the supplied Stylus Tracking Force Gauge as outlined on page 12.*



Figure 11

9. Remove the protective film material from the Tone Arm Rest Position. Refer to figures 12 and 13.

*Note: If another Phono Cartridge (such as the McIntosh MCC10) is to be used with the MT2 turntable, proceed to "Installing a non-supplied Cartridge" at this time on page 10.*

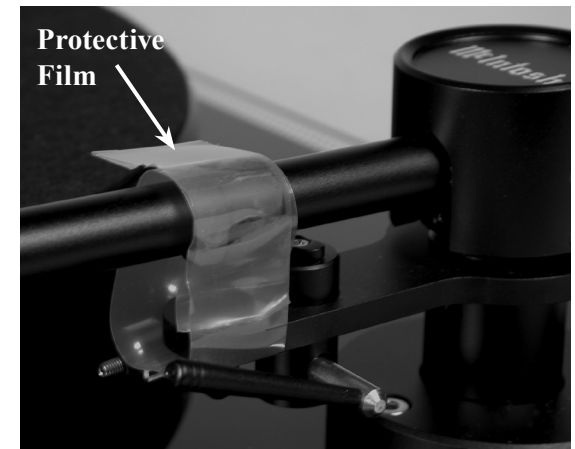

Figure 12



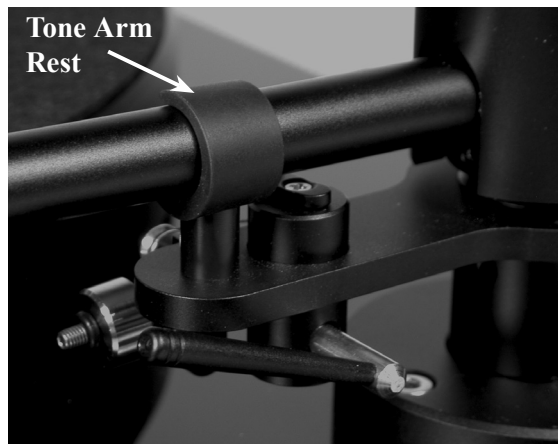

Figure 13

10. Carefully slide off the Stylus Guard from the cartridge by pulling the cover straight down. Refer to figures 14 and 15.

*Note: The Anti-Skating and other adjustments have been preset at the factory for optimum performance. For additional information on setting Tracking Force, Anti-Skating and other adjustments refer to pages 10 thru 12.*

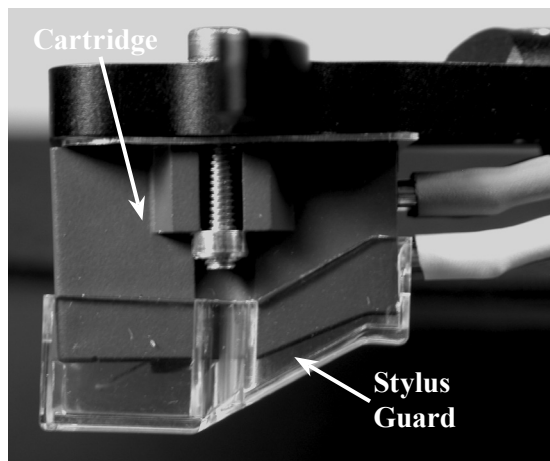

Figure 14

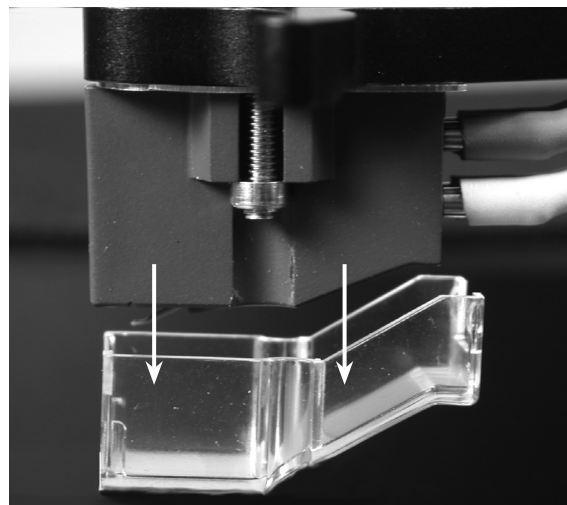
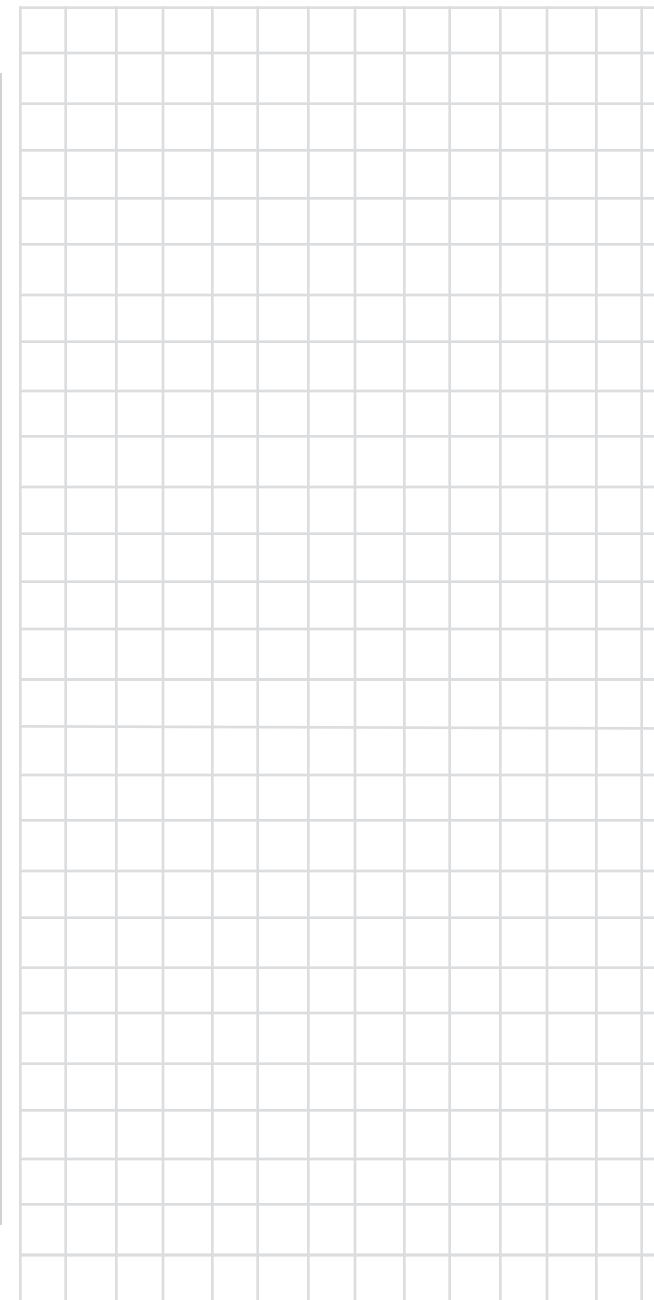

Figure 15

11. Using the supplied Tracking Force Scale, set the force to 1.8 - 2.2 gm for the Sumiko Moonstone Cartridge.
12. Proceed to "How to Connect the Turntable" on page 14.



## Installing a non-supplied Cartridge

**CAUTION:** To prevent possible damage to the turntable platter bearing, do not move the MT2 Precision Turntable with the platters installed.

In the event a non-supplied Phono Cartridge is to be installed into the McIntosh MT2 Turntable, please follow the steps below:

*Note: It is recommended that the Professionals at your McIntosh Dealer, who are skilled in all aspects of installation and adjustment of the McIntosh MT2 Precision Turntable, perform the assembly, installation and adjustments.*

1. Un-install the factory installed Phono Cartridge from the MT2 Tone Arm. First, place the Stylus Guard on the Cartridge. Carefully disconnecting the four push-on wire clips from the phono cartridge rear connection pins, using an appropriate tool. Then remove the mounting screws and nuts using the supplied allen wrench. Place the removed cartridge, spacer plate, screws and nuts in a safe place for possible future use. Refer to figures 18 and 19.

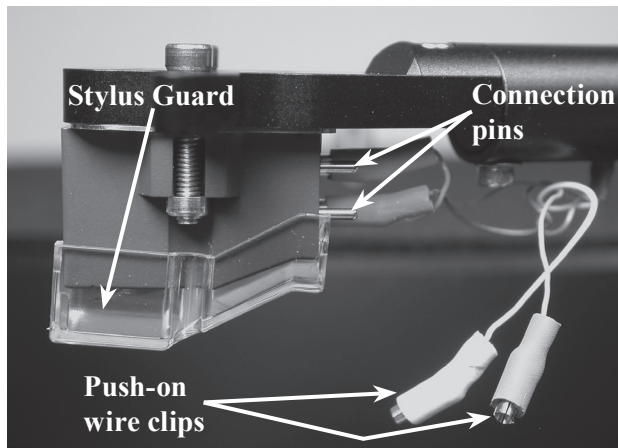

Figure 18

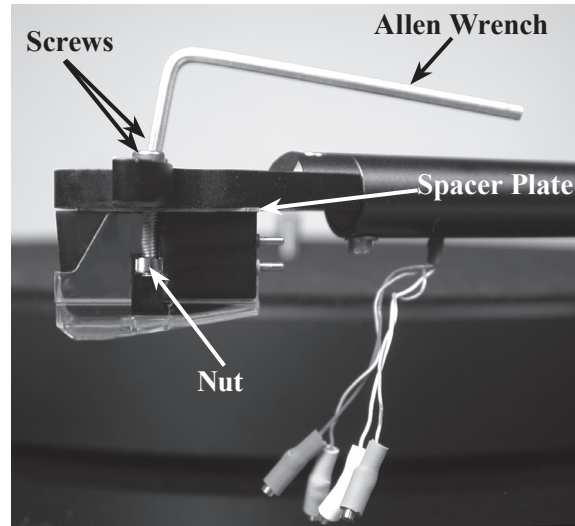

Figure 19

2. Locate the Hardware Package supplied with the new cartridge.
3. Using an appropriate tool, attach the four color coded wire lead connections coming from the front underside of the Tone Arm onto the rear of the new Phono Cartridge, following the instructions supplied with the Cartridge. Refer to figure 18. Below is the Tone Arm Headshell wire color lead identification:

Wire Color

- Red - Right Channel Positive (+) Signal Connection
- Green - Right Channel Negative (-) Ground Connection
- White - Left Channel Positive (+) Signal Connection
- Blue - Left Channel Negative (-) Ground Connection

4. Position the Cartridge parallel to front and sides of the headshell and secure it with the supplied screws and nuts using the appropriate tools. Refer to figure 19.
5. Proceed to "Tone Arm Adjustments".

## Tone Arm Adjustments

### Phono Cartridge/Headshell Alignment

The MT2 Turntable Tone Arm, like all pivoting Tone Arms, follows a slight arc as it transverses across the surface of a phonograph record. By adjusting the distance between the horizontal pivot point of the Tone Arm and the Stylus Tip, the angular error across the playback arc is minimized. The Tone Arm Headshell of the MT2 Turntable allows for making this adjustment by positioning of the Phono Cartridge relative to the Headshell. Follow the steps below using the supplied McIntosh Tone Arm/Cartridge Alignment Gauge:

1. Remove the Stylus Guard.
2. Place the Gauge over the center spindle post on the Platter and position the Gauge so the curved end is in contact with the horizontal pivot of the Tone Arm. Refer to figures 20 and 21.

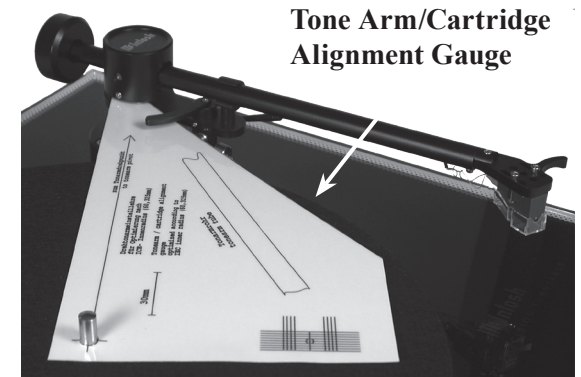

Figure 20

3. With the Anti-Skate Adjustment set to minimum (refer to figure 32), carefully place the Tone Arm onto the Alignment Gauge with the diamond tip of the stylus on the center of the small circle located between the parallel lines. Refer to figures 22 and 23.

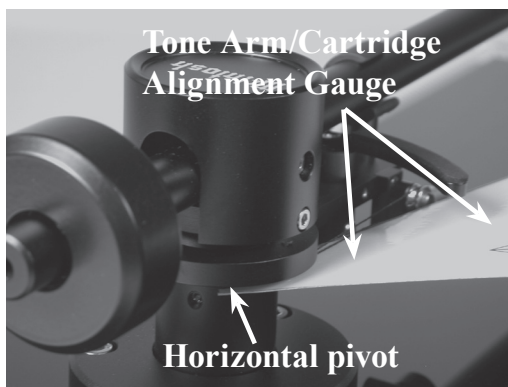

Figure 21

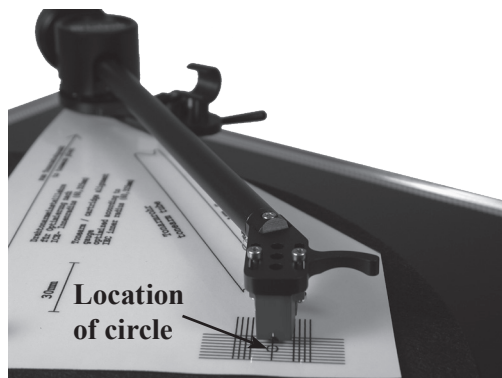

Figure 22

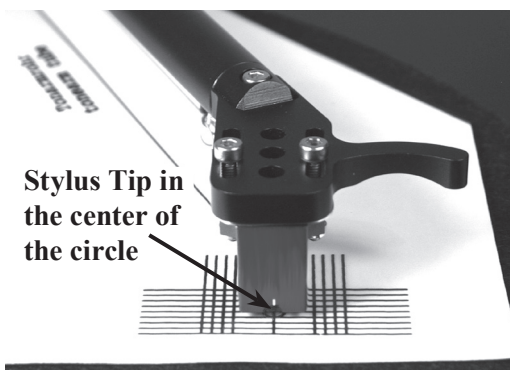

Figure 23

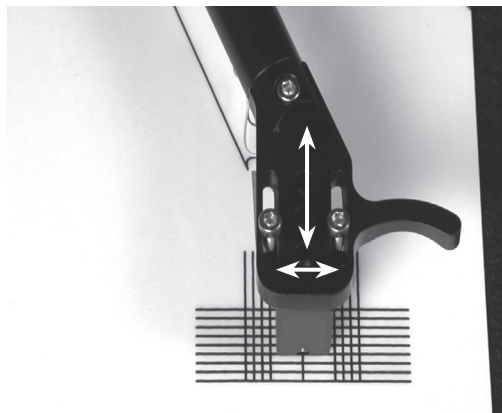

Figure 24

*Note: It may be necessary to slide the Phono Cartridge forward or backward in the headshell to position the stylus in the center of the circle.*

4. It is important the Front and Sides of the Cartridge Body line up with these parallel lines when looking down over the top of the Tone Arm. Refer to figures 23 and 24. If it is not parallel, loosen the mounting hardware securing the Phono Cartridge to the Tone Arm. Reposition the Phono Cartridge so the tip of the stylus is in the center of the small circle and the Front and Sides of the Phono Cartridge are parallel to the lines on the Alignment Gauge. Tighten up the mounting hardware and verify the correct alignment.

### Tone Arm Height

To assure the best sound reproduction, it is very important the MT2 Tone Arm is parallel to the record surface during playback. The height of the Tone Arm is adjustable to accommodate the different Phono Cartridge physical heights. To adjust for the proper Tone Arm Height, perform the following the steps:

1. Release the Tone Arm from the Tone Arm Rest, place it on a record and check to see if the Tone

Arm is parallel to the surface of the record. Refer to figure 25.

With the Tone Arm parallel, no adjustment is needed and proceed to “Setting the Tracking Force”. If the Tone Arm is not parallel, note whether the rear of the Tone Arm needs to go up or down.

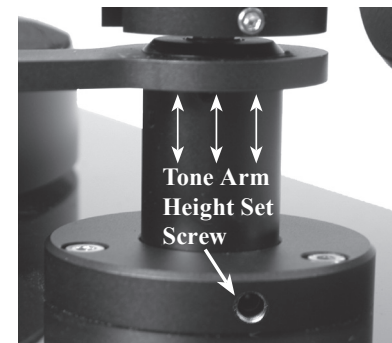

Figure 25

2. With the Tone Arm secured in the Tone Arm Rest, carefully loosen the set screw while supporting the rear of the Tone Arm. Reposition the Tone Arm based on findings in the previous step. Temporarily tighten one of the set screws. Refer to figure 26.

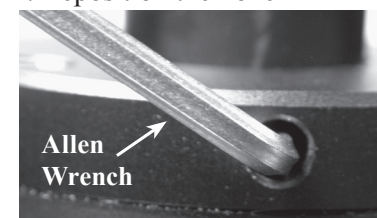

Figure 26

3. Release the Tone Arm from the rest and place it on a record and check to see if the Tone Arm is now parallel. Also check to make sure the Tone Arm is parallel to the record platter and the right side of the turntable base. Refer to figure 27.

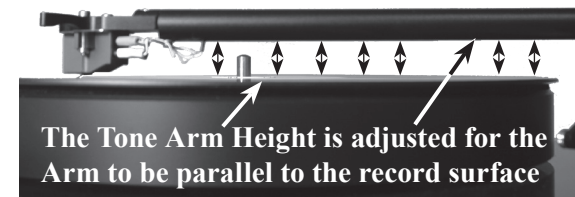
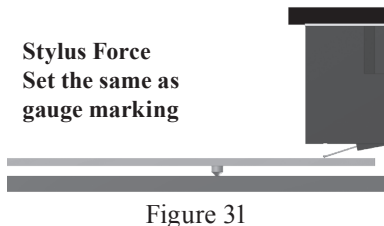
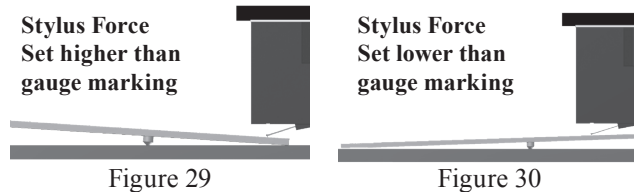
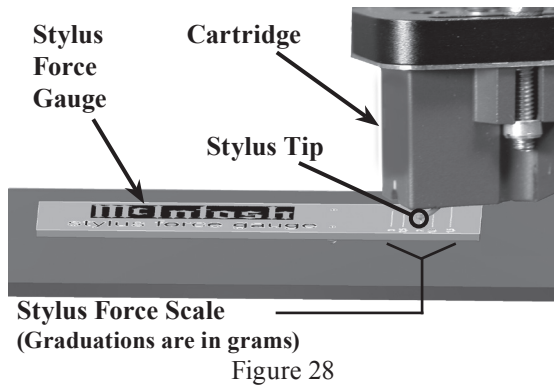

Figure 27

- With the Tone Arm parallel to the record surface, record platter and turntable base, tighten the set screw, which was loosened in step 2. If not, repeat steps 1, 2 and 3 until the Tone Arm is parallel.

### Setting the Tracking Force

The MT2 is supplied with a Stylus Tracking Force Gauge for checking and adjusting the Stylus Tracking. The Gauge uses the “Balance Scale” methodology for measurement. Place the Gauge on the record mat and perpendicular to the front of the Tone Arm, with the Stylus Tip over graduation marks. Set the Anti-Skate Adjustment to minimum (refer to figure 32). Adjust



the position of the Tone Arm Counterweight to establish a tracking force in the middle of the recommend range from the Cartridge manufacturer as a starting place. Refer to figures 28 thru 31.

*Note: Usually, adjusting the tracking force closer to the maximum setting recommend by the Cartridge Manufacturer will produce better sound with less record and stylus wear. Refer to “Trackability Adjustments” for additional information.*

### Anti-Skating Adjustment

The MT2 has adjustable Anti-Skating to equalize the pressure on both sides of the record groove wall by rotating the Anti-Skating Weight Up and Down the threaded shaft, refer to figure 32.

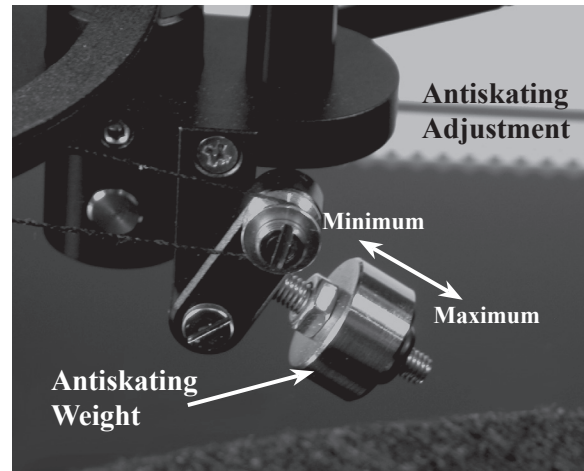

For additional information about Tracking Force and Anti-Skating refer to “Trackability Adjustments”.

### Trackability Adjustments

During playback of Phonograph Recordings, the stylus assembly is subjected to all kinds of extreme operating conditions. One of those conditions is the forces constantly trying to push the stylus up and out of the grooved wall of the recording. Another condition is the uneven side to side pressure applied to the stylus as it tries to stay in contact with both sides of the groove wall of the recording. Refer to figure 35.

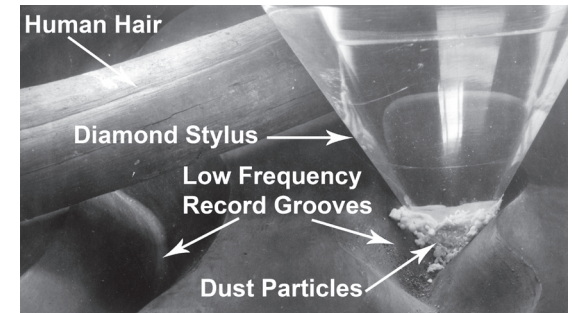

Figure 35

The Anti-Skating Adjustment permits equalizing for even side to side pressure. The correct amount of Tracking Force and Anti-Skate varies with the exact shape of the Stylus Tip and finally the audio signal (both frequency and amplitude) contained in the groove wall of the record.

To achieve good performance and the least amount of Stylus Tip/Record Groove wear, use a Trackability Test Record. Both Tracking Force and Anti-Skate Adjustments are made as a result of listening to the test record to reduce different forms of audible distortions. Never exceed the manufacturers recommend Maximum Tracking Force Setting.

Your McIntosh Dealer, using Test Measurement Equipment and Professional Test Recordings, can achieve via adjustments, the best possible sound quality from your record collection and ensure the greatest longevity.

Audio OUTputs connect to PHONO Inputs of the Preamplifier, Integrated Amplifier or A/V Control Center. For specific information on the type of Phono Input to use, please refer to the next page

Connect to the AC / DC Adapter supplied with the MT2 Turntable. Then connect the AC / DC Adapter to a live AC outlet. Refer to information on the Power Supply to determine the correct voltage



GND (Ground) connects to GND (Ground) connection on the Preamplifier, Integrated Amplifier or A/V Control Center

Fine speed adjustments for 33-1/3 and 45 rpm. These Adjustments require special test records and precision measurement equipment to accurately set the speeds. Contact your McIntosh Dealer for assistance

## How to Connect the Turntable

1. Connect a wire from the MT2 GND (Ground) Post to the GND (Ground) Post on the McIntosh Preamplifier, Integrated Amplifier or A/V Control Center.
2. Connect Audio Cables from the MT2 OUT LEFT and RIGHT Jacks to the MM (Moving Magnet) Inputs on a McIntosh Preamplifier, Integrated Amplifier or A/V Control Center.

*Notes: 1. For additional information about obtaining optimum performance from the installed phono cartridge, refer to page 16 "Phono Cartridge Loading".*  
 2. Contact your McIntosh Dealer for additional information and assistance.

3. Connect the supplied AC / DC Adapter to the MT2 DC IN 12V socket and the Power Supply to a live AC outlet.

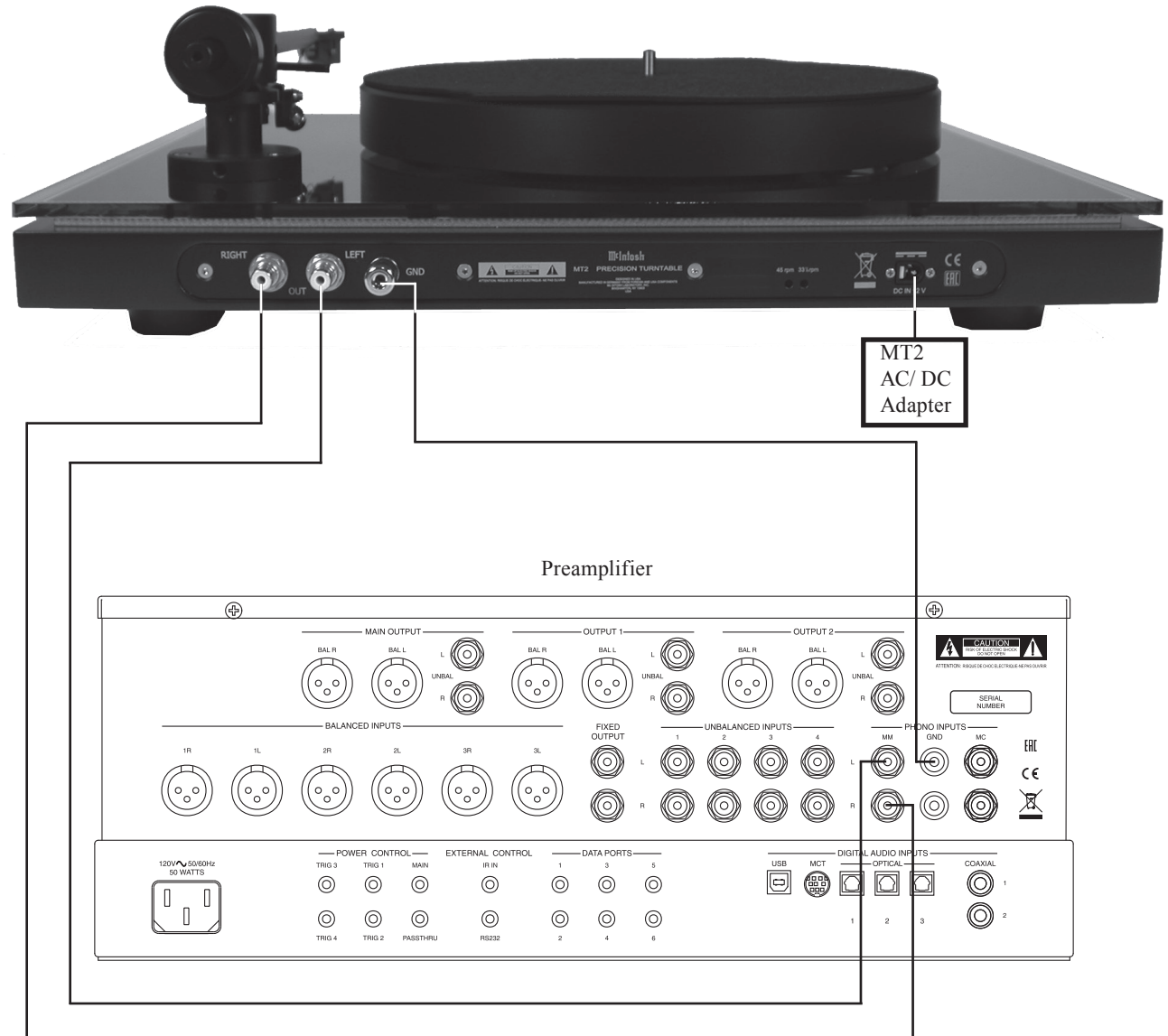

Record clamp helps to keep the phonograph recording flat during playback



Power and Speed Switch turns AC Power OFF or On with selection of 33 1/3 rpm or 45 rpm Playback speed

Raises and lowers the Turntable Tone Arm

## How to Operate the Turntable

### Power and Speed Selection

Rotate the POWER and SPEED Switch to select the playback speed (33-1/3 rpm or 45 rpm) of the phonograph record to be played. Refer to figure 36.

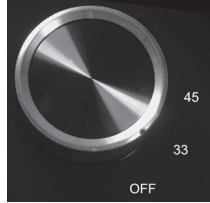

Figure 36

**Power Off** - The Top Panel illumination is switched OFF and there is no Turntable Platter rotation.

**Power 33** - The Top Panel is illumination and the Turntable Platter is rotating at the 33-1/3 rpm speed.

**Power 45** - The Top Panel is illumination and the Turntable Platter is rotating at the 45 rpm speed.

### Phono Cartridge Loading

For optimum performance it is important the Phono-Cartridge be connected to the correct load impedance. Refer to the respective Owner's Manual for the Preamplifier, Integrated Amplifier or Audio/Video Control Center used with the MT2 for additional information.

The Moonstone Cartridge supplied with the MT2 Turntable is a Moving Magnet Type. Set the load resistance to 47 K Ohms and 50 pF Capacitance (or the closest available value).

### Tone Arm Lift

The McIntosh MT2 Precision Turntable has a Tone Arm Lift Mechanism for safe placement and removal of the cartridge stylus on the phonograph record. Perform the following steps:

1. Push on the top part of the Tone Arm Lift Lever towards the rear of the turntable. Refer to figure 37.

### Tone Arm Holder

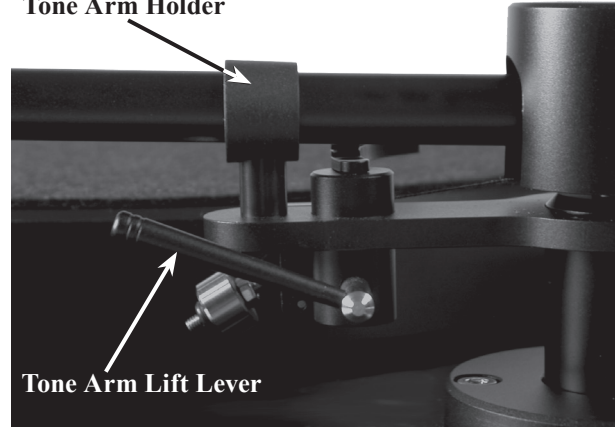

Figure 37

2. Release the Tone Arm from the Tone Arm Holder.
3. Position the Tone Arm over the desired spot of the Phonograph record.
4. Pull on the top part of the Tone Arm Lift Lever towards the front of the turntable to begin playback.







### **Moonstone Cartridge Specifications**

**Cartridge Type**

Moving Magnet

**Output Level**

3.0 mV at 5 cm/s

**Load Impedance**

47K ohms recommended (Preamp MM Input)

**Frequency Response**

12 Hz to 33KHz

**Channel Separation**

30dB at 1kHz

**Channel Balance**

0.5 dB at 1kHz

**Tracking Force Range**

1.8 to 2.2 grams

**Recommended Tracking Force**

2.0 grams

**Compliance**

12 x 10<sup>-6</sup> cm/dyne

**Total Mass**

6.5 grams

**Stylus**

Elliptical Diamond

**Cantilever Material**

Aluminum

### **MT2 Turntable Specifications**

**Playback Speeds**

33 1/3 rpm and 45 rpm

**Motor Type**

DC Stainless Steel Brushes

**Speed Control**

Servo System

### **General Specifications**

**Overall Dimensions**

Width is 17-13/16 inches (45.2cm)

Height is 5 inches (12.7cm) (without Dust Cover)

*Note: The Turntable Height is affected by the type of Cartridge installed and the required Tone Arm Height Adjustment.*

Height is 6 inches (15.2cm) (with Dust Cover)

Depth is 17 inches (43.2cm) (including Cables)

**Weight**

29 pounds (13.2Kg) net, 39 pounds (17.6Kg) in shipping carton

**Shipping Carton Dimensions**

Width is 22-1/4 inches (56.5cm)

Depth is 18 inches (45.7cm)

Height is 15-1/2 inches (39.4cm)

**Packing Instructions**

In the event it is necessary to repack the equipment for shipment, the equipment must be packed exactly as shown below. It is very important the four feet are still attached to the bottom of the equipment. This will ensure the proper equipment location on the Platter foam pads. Failure to do this will result in shipping damage.

Use the original shipping carton and interior parts only if they are all in good serviceable condition. If a shipping carton or any of the interior part(s) are needed, please call or write Customer Service Department of McIntosh Laboratory. Refer to page 2. Please refer to the Part List below for the correct part numbers.

| Quantity | Part Number | Description  |
|----------|-------------|--|
| 1        | 310599SP    | Top Foam Packing                                   |
| 1        | 310598SP    | Foam Packing for Top of the Dust Cover             |
| 1        | 310596SP    | Foam Packing for Bottom of the Dust Cover          |
| 1        | 310597SP    | Foam Packing for Top of the Turntable              |
| 1        | 310595SP    | Foam Packing for Accessories and Outer Platter Set |
| 1        | 310594SP    | Shipping Carton only                               |

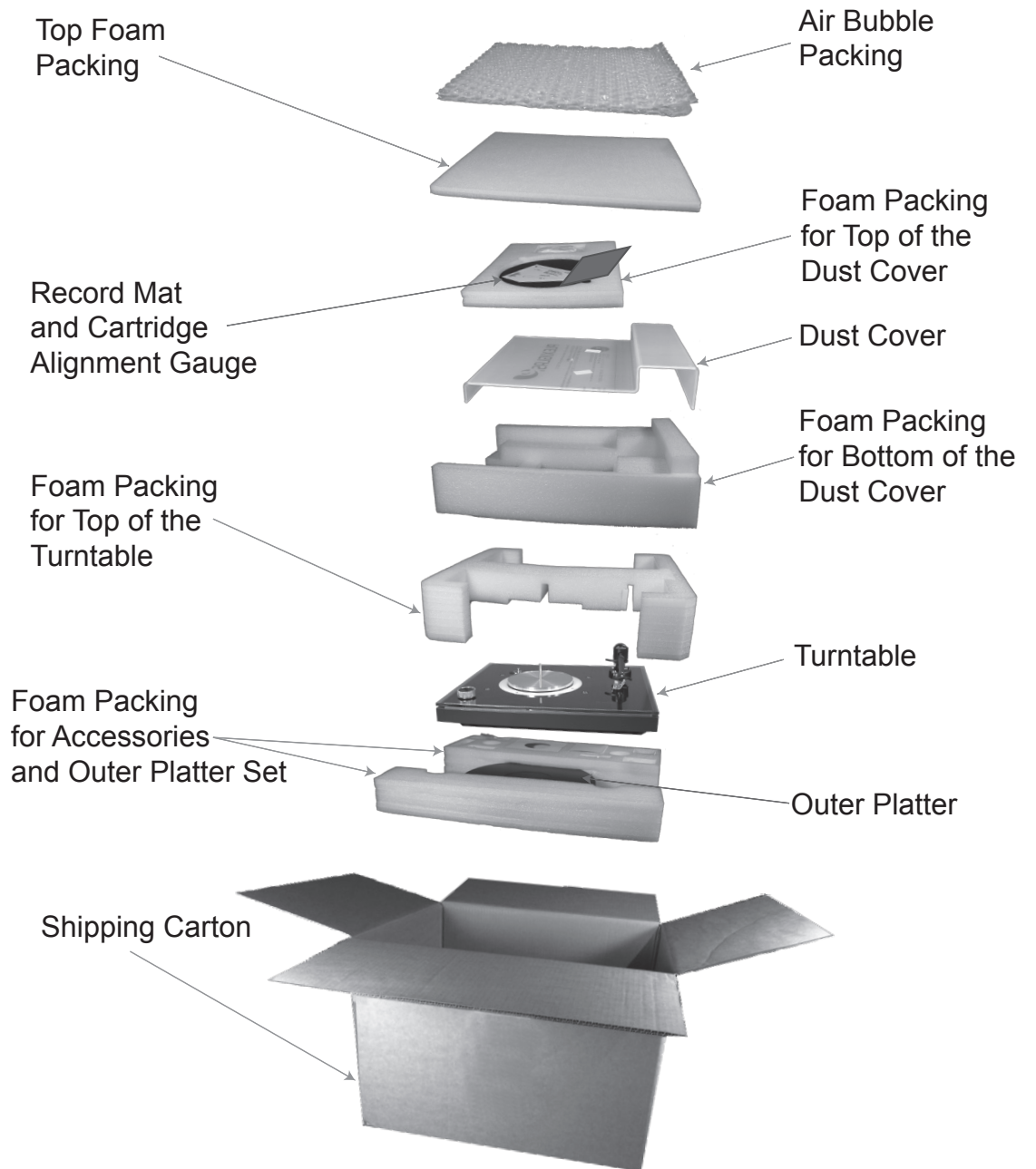



McIntosh Laboratory, Inc.  
2 Chambers Street  
Binghamton, NY 13903  
[www.mcintoshlabs.com](http://www.mcintoshlabs.com)

The continuous improvement of its products is the policy of McIntosh Laboratory Incorporated who reserve the right to improve design without notice.  
Printed in the U.S.A.