



McIntosh Laboratory, Inc. 2 Chambers Street Binghamton, New York 13903-2699 Phone: 607-723-3512 www.mcintoshlabs.com

C2500
Tube Preamplifier
Owner's Manual



The lightning flash with arrowhead, within an equilateral triangle, is intended to alert the user to the presence of uninsulated “dangerous voltage” within the product’s enclosure that may be of sufficient magnitude to constitute a risk of electric shock to persons.

WARNING - TO REDUCE RISK OF FIRE OR ELECTRICAL SHOCK, DO NOT EXPOSE THIS EQUIPMENT TO RAIN OR MOISTURE.

IMPORTANT SAFETY INSTRUCTIONS!

PLEASE READ THEM BEFORE OPERATING THIS EQUIPMENT.

1. Read these instructions.
2. Keep these instructions.
3. Heed all warnings.
4. Follow all instructions.
5. Do not use this apparatus near water.
6. Clean only with a dry cloth.
7. Do not block any ventilation openings. Install in accordance with the manufacturer’s instructions.
8. Do not install near any heat sources such as radiators, heat registers, stoves, or other apparatus (including amplifiers) that produce heat.
9. Do not defeat the safety purpose of the polarized or grounding-type plug. A polarized plug has two blades with one wider than the other. A grounding type plug has two blades and a



AVIS RISQUE DE CHOC ELECTRIQUE - NE PAS OUVRIR.

NO USER-SERVICEABLE PARTS INSIDE. REFER SERVICING TO QUALIFIED PERSONNEL.

third grounding prong. The wide blade or the third prong are provided for your safety. If the provided plug does not fit into your outlet, consult an electrician for replacement of the obsolete outlet.

10. Protect the power cord from being walked on or pinched particularly at plugs, convenience receptacles, and the point where they exit from the apparatus.
11. Only use attachments/accessories specified by the manufacturer.
12. Use only with the cart, stand, tripod, bracket, or table specified by the manufacturer, or sold with the apparatus. When a cart is used, use caution when moving the cart/apparatus combination to avoid injury from tip-over.
13. Unplug this apparatus during lightning storms or when unused for long periods of time.
14. Refer all servicing to qualified service personnel. Servicing is required when the apparatus has been damaged in any way, such as power-



The exclamation point within an equilateral triangle is intended to alert the user to the presence of important operating and maintenance (servicing) instructions in the literature accompanying the appliance.

To prevent the risk of electric shock, do not remove cover or back. No user-serviceable parts inside.

supply cord or plug is damaged, liquid has been spilled or objects have fallen into the apparatus, the apparatus has been exposed to rain or moisture, does not operate normally, or has been dropped.

15. Do not expose this equipment to dripping or splashing and ensure that no objects filled with liquids, such as vases, are placed on the equipment.
16. To completely disconnect this equipment from the a.c. mains, disconnect the power supply cord plug from the a.c. receptacle.
17. The mains plug of the power supply cord shall remain readily operable.
18. Do not expose batteries to excessive heat such as sunshine, fire or the like.
19. Connect mains power supply cord only to a mains socket outlet with a protective earthing connection.

Thank You

Your decision to own this McIntosh C2500 Tube Pre-amplifier ranks you at the very top among discriminating music listeners. You now have the best. The McIntosh dedication to precision performance assures many years of musical enjoyment.

Please take a short time to read the information in this manual. We want you to be as familiar as possible with all the features and functions of your new McIntosh.

Please Take A Moment

The serial number, purchase date and McIntosh Dealer name are important to you for possible insurance claim or future service. The spaces below have been provided for you to record that information:

Serial Number: _____

Purchase Date: _____

Dealer Name: _____

Technical Assistance

If at any time you have questions about your McIntosh product, contact your McIntosh Dealer who is familiar with your McIntosh equipment and any other brands that may be part of your system. If you or your Dealer wish additional help concerning a suspected problem, you can receive technical assistance for all McIntosh products at:

McIntosh Laboratory, Inc.
2 Chambers Street
Binghamton, New York 13903
Phone: 607-723-3512
Fax: 607-724-0549

Customer Service

If it is determined that your McIntosh product is in need of repair, you can return it to your Dealer. You can also return it to the McIntosh Laboratory Service Department. For assistance on factory repair return procedure, contact the McIntosh Service Department at:

McIntosh Laboratory, Inc.
2 Chambers Street
Binghamton, New York 13903
Phone: 607-723-3515
Fax: 607-723-1917

Table of Contents

Safety Instructions	2
Thank You and Please Take a Moment.....	3
Technical Assistance and Customer Service	3
Table of Contents	3
General Information	4
Connector and Cable Information	4
Introduction.....	5
Performance Features	5
Dimensions	6
Installation	7

Connections:

Rear Panel Connections	8
(Separate Sheet)	Mc2B
Connecting Components.....	9
Connection Diagrams (Separate Sheets).....	Mc1A, Mc1B and Mc2A

Remote Control:

Remote Control Push-buttons.....	10
How to use the Remote Control.....	11

Front Panel:

Front Panel Displays, Controls, Push-buttons and Jack.....	12
---	----

Setup:

How to Operate the Setup Mode	13
Default Settings.....	13
Firmware Version.....	14
Reassign Source Inputs.....	14
Source Input Renaming	15
Input Level Adjustment	16
Power Mode	16
Display Brightness.....	17
Tube Lights	17
Passthru.....	17
Power Control Triggers 1 and 2	18
Comm Port Baud Rate	19
Remote Control Codes.....	19

Operation:

How to Operate the C2500	20-26
Trim Functions.....	20-24
Processor Loop	24
Tone Bypass	24
Output Meters	25
Passthru.....	25
Optical and Coaxial Digital Inputs	25
USB Input Operation with a Computer	25
Reset of Microprocessors.....	26
Resetting the C2500 to default settings	26

Additional Information:

Photos.....	27-28
Specifications.....	29-30
Packing Instruction.....	31

General Information

1. The C2500 uses Vacuum Tubes for amplifying the audio signal. The C2500 is designed to have only qualified Service Personnel perform any part(s) replacement including all the vacuum tubes.
2. For additional connection information, refer to the owner's manual(s) for any component(s) connected to the C2500 Tube Preamplifier.
3. The Main AC Power going to the C2500 and any other McIntosh Component(s) should not be applied until all the system components are connected together. Failure to do so could result in malfunctioning of some or all of the system's normal operations. When the C2500 and other McIntosh Components are in their Standby Power Off Mode, the Microprocessor's Circuitry inside each component is active and communication is occurring between them.
4. **The C2500 includes an Auto Off Power Save Feature and the default setting is enabled.** For additional information including how to disable it, refer to page 16.
5. Balanced and Unbalanced Inputs and Outputs can be mixed. For example, you may connect signal sources to Unbalanced Inputs and send signals from the Balanced Outputs. You can also use Balanced and Unbalanced Outputs simultaneously, connected to different Power Amplifiers.
6. The IR Input, with a 1/8 inch mini phone jack, is configured for non-McIntosh IR sensors such as a Xantech Model HL85BK Kit. Use a Connection Block such as a Xantech Model ZC21 when two or more IR sensors need to be connected to the C2500. When an external sensor is connected to the C2500 the Front Panel sensor is disabled to avoid possible interaction.
7. The C2500 internal Digital to Analog Converter Circuitry is designed to decode 2-channel PCM

- (Pulse Code Modulation) Digital Signal present at the Coaxial and Optical Digital Audio Inputs. Other Digital Audio Signal Format Types will cause the Audio Outputs of the C2500 to be muted and the Front Panel Information Display will indicate an error message.
8. The Remote Control Supplied with the C2500 Preamplifier is capable of operating other components. For additional information go to www.mcintoshlabs.com.
 9. When discarding the unit, comply with local rules or regulations. Batteries should never be thrown away or incinerated but disposed of in accordance with the local regulations concerning battery disposal. 
 10. For additional information on the C2500 and other McIntosh Products please visit the McIntosh Web Site at www.mcintoshlabs.com.

Connector and Cable Information

XLR Connectors

Below is the Pin configuration for the XLR Balanced Input and Output Connectors on the C2500. Refer to the diagrams for connections:

- PIN 1: Shield/Ground
- PIN 2: + Output
- PIN 3: - Output

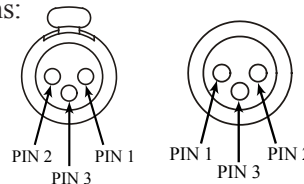

Power Control and Trigger Connectors

The C2500 Power Control Out, Trigger and Pass-Thru Output Jacks send Power On/Off Signals (+12 volt/0

volt) when connected to other McIntosh Components. An additional connection is for controlling the illumination of the Power Output Meters on McIntosh Power Amplifiers. A 3.5mm stereo mini phone plug is used for connection to the Power Control, Trigger and Pass-Thru Outputs on the C2500.

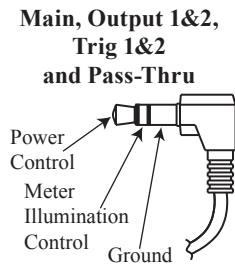

Data Port Connectors

The C2500 Data Out Ports send Remote Control Signals to Source Components. A 3.5mm stereo mini phone plug is used for connection.

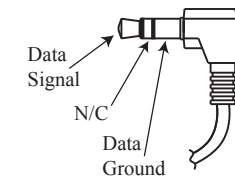

RS232 DB9 Connector Pin Layout

- | | |
|-------------------|--------|
| 1. N/C | 6. N/C |
| 2. Data Out (TXD) | 7. N/C |
| 3. Data In (RXD) | 8. N/C |
| 4. N/C | 9. N/C |
| 5. Gnd. | |

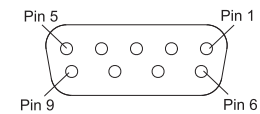

Introduction

The McIntosh C2500 Tube Preamplifier is one of the finest Preamplifiers ever created with connections for both analog and digital sources. The C2500 Outputs have the ability to drive multiple Power Amplifiers. The C2500 reproduction is sonically transparent and absolutely accurate. The McIntosh Sound is “The Sound of the Music Itself.”

Performance Features

• **Electromagnetic Input Switching with Level Trim Adjustment**

Digital Logic integrated circuits drive Electromagnetic Switches on all Inputs and operating functions for reliable, noiseless, distortion free switching. All eight Inputs on the C2500 can be matched in level, so there are no abrupt changes in volume levels between the different Inputs.

• **Moving Coil and Moving Magnet Phono Inputs**

The C2500 contains two different precision Phono Preamplifier Circuits. One for low output Moving Coil Phono Cartridges with selectable resistance loading, the other is for Moving Magnet Cartridges with selectable capacitive loading. Both circuits use the latest designs to provide the lowest possible noise and distortion. The RIAA Correction Equalization Circuitry utilizes close tolerance resistors and capacitors for an extremely flat frequency response.

• **Digital Audio Inputs**

The C2500 has Coaxial, Optical and USB Digital Inputs to Decode PCM Signals from an external source. The C2500 Up Samples the Digital Signal to 192kHz with 32Bit resolution before the Digital to Analog process begins.

• **Balanced Inputs**

The Balanced Inputs allow the connection of a source component using long cable lengths without a loss in sound quality.

• **Precision Tracking Volume Control**

Volume levels are controlled by a new Multi-Stage Precision Digitally Controlled Attenuator System with superb tracking accuracy.

• **Variable Rate Volume and Balance Controls**

The C2500 Tube Preamplifier’s Volume and Balance Control Circuitry provides an ideal rate of change with control rotation.

• **Electronic Tone Controls with Bypass**

Electronic Bass and Treble Circuitry allow volume level adjustments for low and high frequencies in precise one Decibel Steps. The C2500 remembers the Tone Control Circuitry Bypass Option for each input.

• **Alphanumeric Fluorescent Display**

The Front Panel Information Display indicates the Source Selection, Volume/Balance Levels and Setup Mode Selections. The display intensity is adjustable.

• **Processor Loop**

A Processor Loop is provided for connection of an external analog signal processor. The Processor Loop can be switched in or out of the signal path of any assigned Input.

• **Pass-Thru Mode**

The Automatic Pass-Thru Mode allows the C2500 to become part of a Multichannel Sound System for DVD-Audio, SACD and Home Theater Movies.

• **Remote Control with External Sensor Input**

The Remote Control provides control of the C2500 operating functions and McIntosh Source Components connected to it. Enjoy your McIntosh System from another room in your home by connecting an external sensor.

• **Power Control Output and Trigger Assignment**

A Power Control connection for convenient Turn-On of McIntosh Power Amplifiers, Source Components and Accessories is included. The Power Control Trigger Outputs may be assigned to activate when a given Input is selected.

• **Special Power Supply**

Fully regulated Power Supplies and a special R-Core Power Transformer ensure stable noise free operation even though the power line varies.

• **Fiber Optic Solid State Front Panel Illumination**

The even Illumination of the Front Panel is accomplished by the combination of custom designed Fiber Optic Light Diffusers and extra long life Light Emitting Diodes (LEDs).

• **Glass Front Panel and Super Mirror Chassis Finish**

The famous McIntosh Illuminated Glass Front Panel and the Stainless Steel Chassis with Super Mirror Finish ensures the pristine beauty of the C2500 will be retained for many years.

Dimensions

The following dimensions can assist in determining the best location for your C2500. There is additional information on the next page pertaining to installing the C2500 into cabinets.

Front View of the C2500

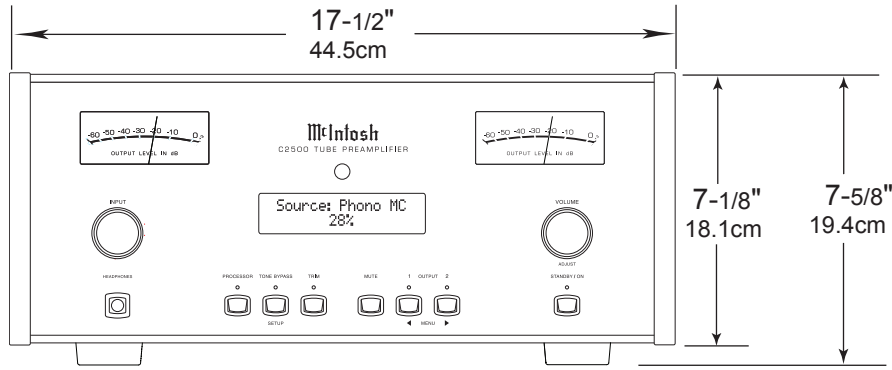

Rear View of the C2500

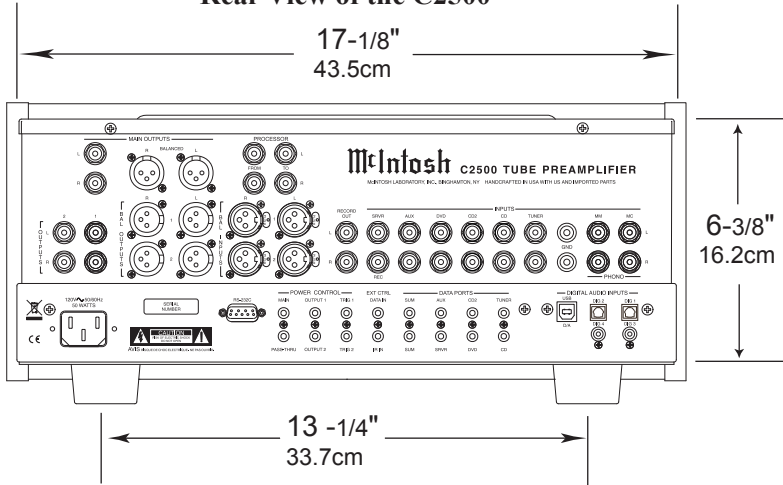

Side View of the C2500

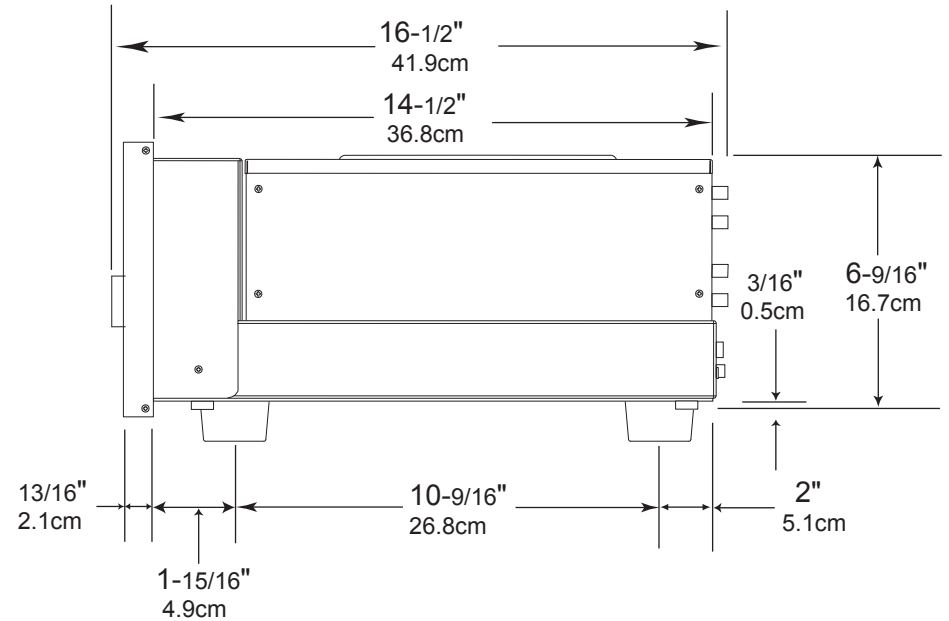

Installation

The C2500 can be placed upright on a table or shelf, standing on its four feet. It also can be custom installed in a piece of furniture or cabinet of your choice. The four feet may be removed from the bottom of the C2500 when it is custom installed as outlined below. The four feet together with the mounting screws should be retained for possible future use if the C2500 is removed from the custom installation and used free standing. The required panel cutout, ventilation cutout and unit dimensions are shown.

Always provide adequate ventilation for your C2500. Cool operation ensures the longest possible operating life for any electronic instrument. Do not install the C2500 directly above a heat generating component such as a high powered amplifier. If all the components are installed in a single cabinet, a quiet running ventilation fan can be a definite asset in maintaining all the system components at the coolest possible operating temperature.

A custom cabinet installation should provide the following minimum spacing dimensions for cool operation.

Allow at least 6 inches (15.2cm) above the top, 2 inches (5.1cm) below the bottom and 1 inch (2.5cm) on each side of the Preamplifier, so that airflow is not obstructed. Allow 20 inches (50.8cm) depth behind the front panel. Allow 1-7/16 inch (3.7cm) in front of the mounting panel for knob clearance. Be sure to cut out a ventilation hole in the mounting shelf according to the dimensions in the drawing.

**C2500 Front Panel
Custom Cabinet Cutout**

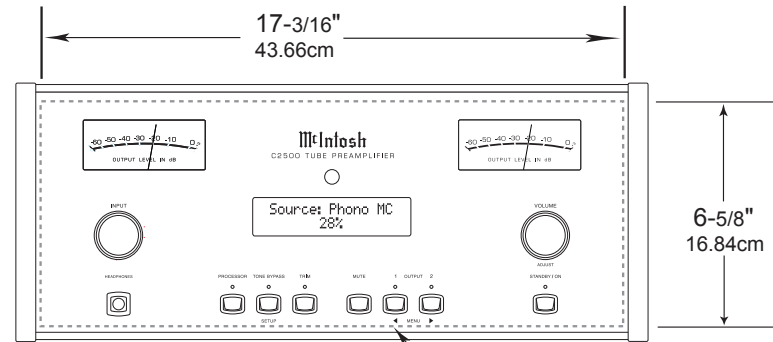

**C2500 Side View
in Custom Cabinet**

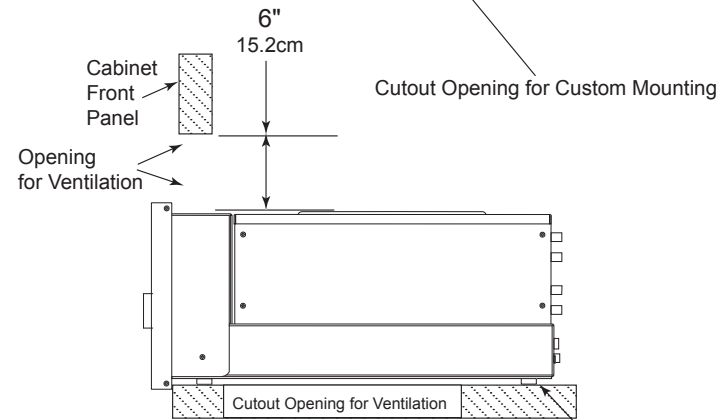

**C2500 Bottom View
in Custom Cabinet**

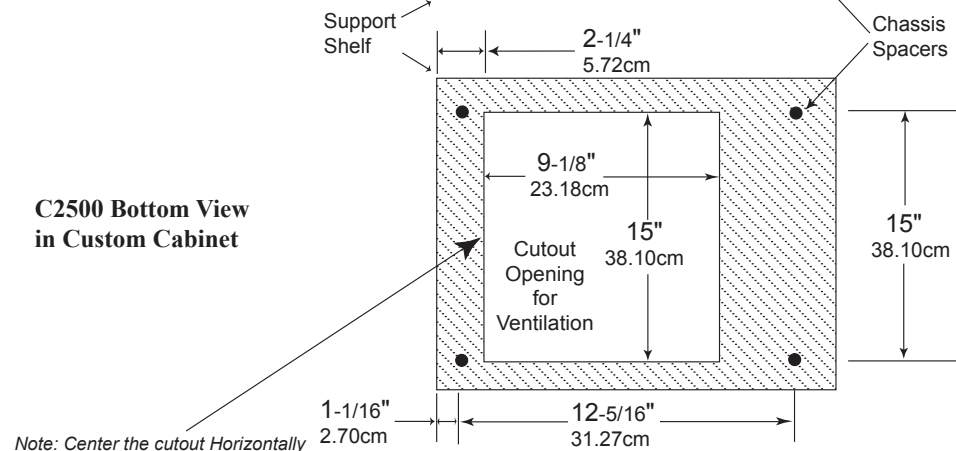

Note: Center the cutout Horizontally on the unit. For purposes of clarity, the above illustration is not drawn to scale.

Rear Panel Connections

The identification of Rear Panel Connections for the C2500 Tube Preamplifier is located on a separate folded sheet contained in the Owner's Manual Packet. Refer to separate sheet "Mc2B" for the Rear Panel Connections.

C2500 Tube Preamplifier Rear Panel

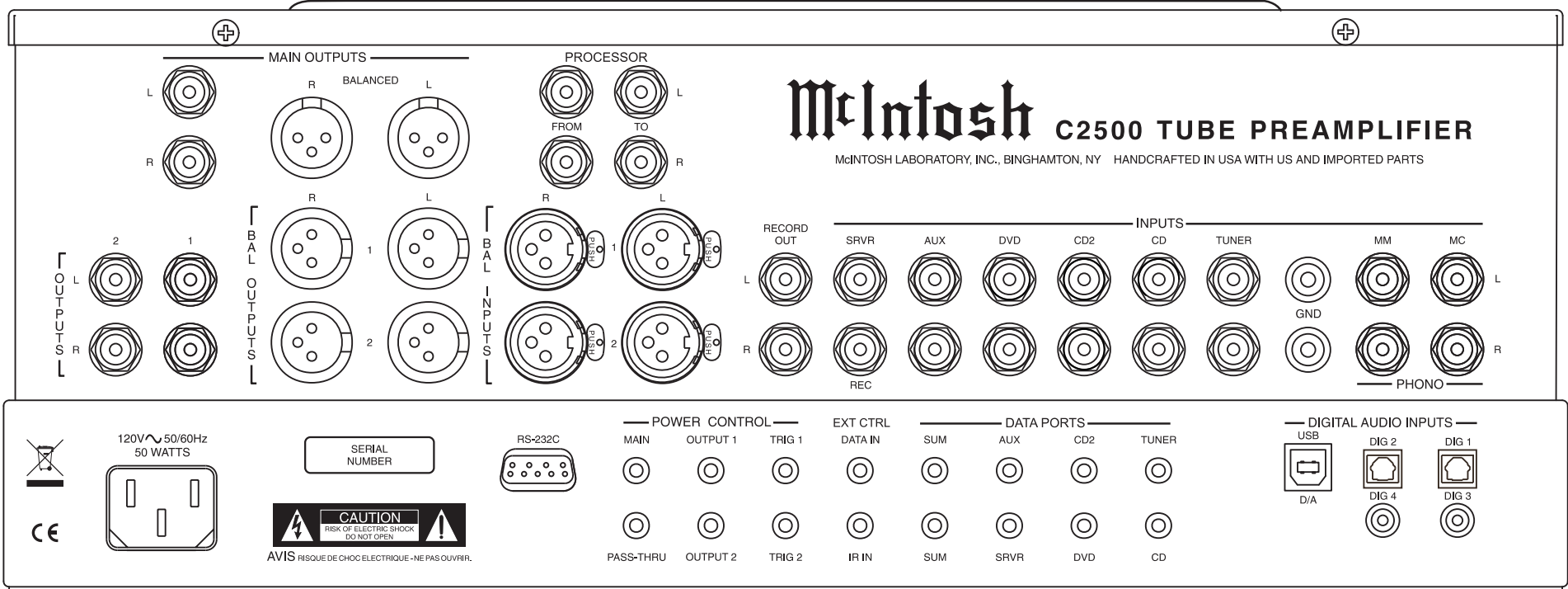

Connecting Components

The C2500 has the ability to automatically switch power On/Off to Source Components via the Power Control connections. The Data Port Connections allow for the remote operation of basic functions using the C2500 Remote Control. With an external sensor connected to the C2500, remote control operation of the system is possible from another room and/or when the C2500 is located in a cabinet with the doors closed.

The connection instructions below, together with the C2500 Input/Output/Control Connection Diagrams located on the separate folded sheets “Mc1A/1B and Mc2A”, are an example of a typical audio system. Your system may vary from this, however the actual components would be connected in a similar manner. For additional information refer to “Connector and Cable Information” on page 4.

Note: Source components may be connected to the C2500 Balanced Inputs or Digital Inputs instead of Unbalanced Inputs. Refer to Setup “Reassigning Inputs” to activate them on page 14.

Power Control Connections:

1. Connect a Control Cable from the C2500 POWER CONTROL MAIN Jack to the Power Control In on the Turntable.
2. Connect a Control Cable from the Turntable Power Control Out Jack to the SACD/CD Player Power Control In Jack.
3. Connect a Control Cable from the SACD/CD Player Power Control Out Jack to the Tuner Power Control In Jack.
4. Connect a Control Cable from the C2500 POWER CONTROL OUTPUT 1 Jack to the Power Amplifier Power Control In Jack.

Note: If two Power Amplifiers are used, connect the Power Control Output of the first Amplifier to the Power Control Input on the second Amplifier.

5. Optionally connect a Control Cable from the C2500 POWER CONTROL OUTPUT 2 Jack to the Power Amplifier (Secondary Room) Power Control In Jack.
6. Connect any additional Components in a similar manner, as outlined in steps 1 thru 4.

Data Control Connections:

7. Connect a Control Cable from the C2500 TUNER DATA PORTS Jack to the TUNER Data In Jack.
8. Connect a Control Cable from the C2500 CD DATA PORT Jack to the SACD/CD Player Data In Jack.
9. Connect any additional McIntosh Components in a similar manner, as outlined in steps 7 thru 8.

Sensor Connection:

10. Connect a Control Cable from the C2500 IR Input Connector to the external Sensor.

Audio Connections:

11. Connect an Audio Cable from the C2500 TUNER INPUT Jacks to the Tuner (Fixed) Output Jacks.
12. Connect an Audio Cable from the C2500 CD INPUT Jacks to the SACD/CD Player (Fixed) Output Jacks.
13. Connect the Audio Cables coming from the Turntable to the C2500 MC PHONO INPUT Jacks.
Note: If the Turntable has a Moving Magnet Cartridge connect the audio cables to the C2500 MM PHONO INPUT instead of the MC Input.
14. Connect Balanced Cables from the C2500 BALANCED OUTPUT 1 connectors to the Power Amplifiers Balanced (Left and Right) Inputs.
15. Optionally Connect an Audio Cable from the C2500 BALANCED OUTPUT 2 connectors to the Power Amplifier (Secondary) Inputs.
16. Connect any additional McIntosh Components in a similar manner, as outlined in steps 11 thru 14.

Optional “PassThru” Connections:

17. Connect Balanced Cables from the A/V Control Center Front Left and Right Channel Balanced Output connectors to the BALANCED 2 Input connectors.

Note: Refer to Setup “PassThru” on page 17 to activate the BALANCED 2 Input.

18. Connect a Control Cable from the C2500 PASSTHRU to A/V Control Center Zone ZA Power Control Output.

Optional USB Connection:

19. Connect a USB cable with (type A to type B) connectors from the C2500 USB D/A Input to an available USB connector.

Ground Connections:

20. Connect the Ground Cable coming from the Turntable to the C2500 GND Binding Post.

AC Power Cords Connections:

21. Connect the C2500 and any remaining components’ AC Power Cords to a live AC outlet as illustrated.

LED illuminates during the time a remote command is sent to the C2500

Switches the Trigger 1 and/or 2 Power Control Jack(s) On/Off, refer to “Setup, Power Control TRIG 1 and TRIG 2” on page 18 for additional information

Selects a Disc Player, Music Server or Recorder Function. Seek Stations Up or Down the AM/FM Dial. Select AM/FM Station Presets and performs various functions on a variety of McIntosh Components

Displays On Screen Functions on the McIntosh Music Server and a variety of other McIntosh Components

Adjusts the volume level up or down

Activates the TRIM Stereo/Mono Mode

Mutes the audio

Selects AM Tuner Operating Functions and Disc Selection on certain McIntosh Disc Players

Selects Functions as a “shift” key when used with the AM or FM push-buttons to select Output 1 or 2

Scrolls through the available C2500 Inputs

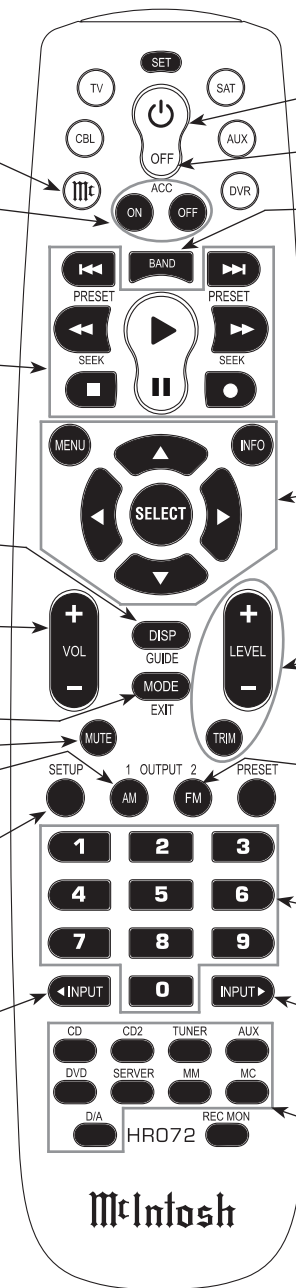

Press to Power the C2500 ON

Press to Power the C2500 OFF

Press to change broadcast bands on an external McIntosh Tuner connected. Select certain functions on a variety of McIntosh Components

Selects On Screen Functions on a variety of McIntosh Components

Press TRIM and then the LEVEL Push-buttons to select and adjust various functions

Selects FM Tuner Operating Functions and Track Selection on certain McIntosh CD Players

Use to select tuner presets, disc tracks or any numbered operation

Scrolls through the available C2500 Inputs

Selects one of the eight available Audio Sources

Note: Push-buttons whose function is not identified above are for use with other McIntosh Products.

How to use the Remote Control

The supplied HR072 Remote Control is capable of directly controlling the functions of contemporary Source Components connected to the C2500 via the Data Ports.

Note: If at any time the C2500 seems unresponsive to HR072 Remote Control Commands press the  Push-button first.

Input Source Selection

Press the appropriate Source Push-button to select the desired program source.

Note: When the C2500 is Off, pressing one of the Source Push-buttons will switch the C2500 On and it will go to that Input.

Mute

Press the MUTE Push-button to mute the audio in all outputs except the REC OUTPUT. The word MUTE will appear on the Front Panel Information Display. To un-mute the audio, press the MUTE Push-button again.

Disc, Server and Recorder Functions

Use these push-buttons to operate a DVD Player, CD Player, CD Changer, Music Server or Recorder.







Numbered Push-buttons

Press Push-buttons 0 through 9 to access tuner station presets, tracks on discs or selections on a Music Server.

Disc and Track

Use the AM (disc) and FM (track) Push-buttons when a Disc Player or Music Server is being used.

Tuner Push-buttons

Press the AM or FM Push-button to select the desired broadcast band. Press and release the Preset  or Preset  Push-button for the next Station Preset. Press the Seek  or Seek  Push-button to seek continuously from station to station. To Manually Tune press and hold a Directional Up  or Down  Push-button to find available stations.

Volume



Press the Up  or Down  VOLUME Push-button to raise or lower the listening volume level.

Note: The Record Signals present at REC OUTPUTS are not affected by volume changes.

Pause

Press the Pause  Push-button to perform various functions on a variety of McIntosh Components. It will also pause the playing of a disc or tape player.

Trim

Press the TRIM Push-button until the desired Trim function (Balance, Trim Level, etc.) appears on the Front Panel Information display, then press the LEVEL Up  or Down  Push-button to adjust the Trim setting.

Note: Press the TRIM Push-button to recall the last Trim function selected. For additional information on the Trim Functions refer to pages 20 thru 24.

Amplifier Selection

Press the BLUE (Setup) Push-button followed by the AM (Output 1) or FM (Output 2) Push-button, to control the rear panel Audio OUTPUTS 1, 2 (ON or OFF) and Power Control OUTPUT 1 / OUTPUT 2. These OUTPUTS provide signals to a Power Amplifier or other accessory component.





Front Panel Displays, Controls, Push-buttons and Jack

INPUT Control allows the selection of various sources for listening and recording

Meter indicates the Left Channel Output of the Preamplifier

IR Sensor receives commands from a Remote Control

INFORMATION DISPLAY indicates the Sources, Volume, other Audio Settings, Operational Functions and Setup Mode Settings

Meter indicates the Right Channel Output of the Preamplifier

VOLUME Control allows adjustment of the listening level for both channels
ADJUST is also used in the setup mode for various functions

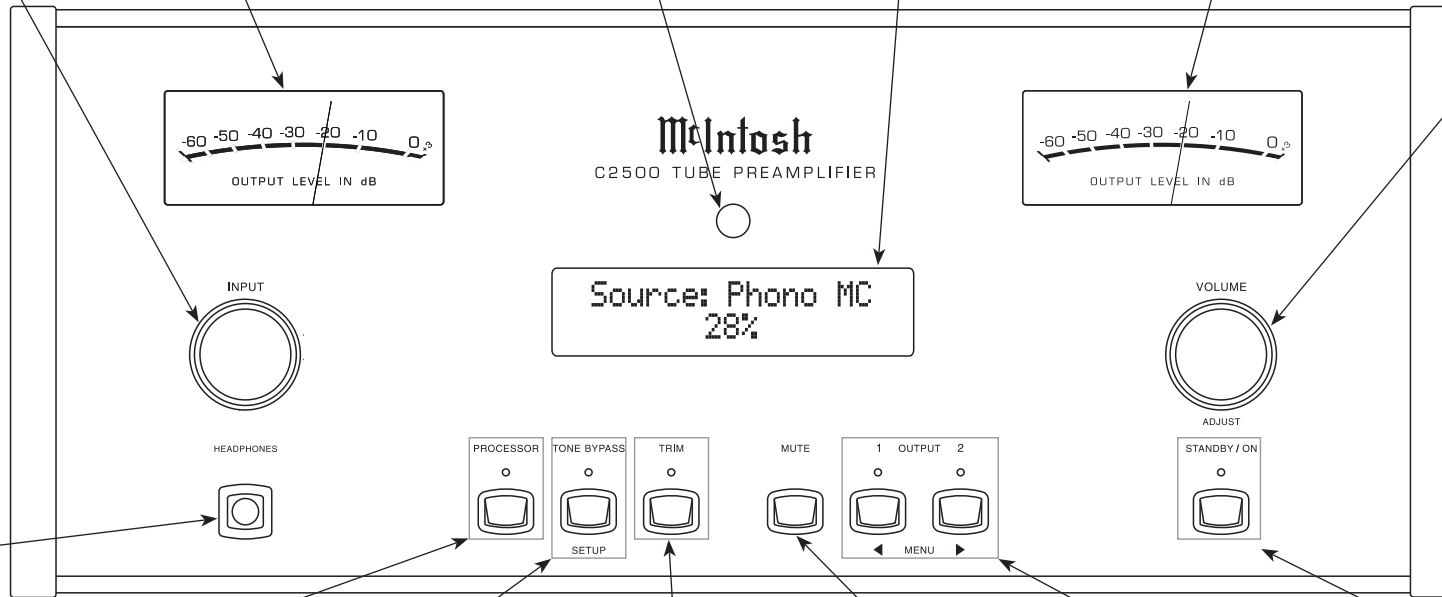

Connection for dynamic headphones, for private listening

PROCESSOR Push-button with indicator, when activated places an externally connected signal processor in the listen signal path

TONE BYPASS Push-button with indicator, when activated the audio signal bypasses the Tone Controls, also used to activate the Setup Mode

TRIM Push-button with indicator, allows selection of various types of settings

MUTE Push-button mutes the audio from the Loudspeakers and Headphones

OUTPUT 1 and 2 Push-buttons with indicators, switch the Preamplifier Outputs 1 and 2 On or Off

STANDBY/ON Push-button with indicator, switches the C2500 ON or OFF (Standby) and resets the microprocessors

How to Operate the Setup Mode

Your McIntosh C2500 has been factory configured for default operating settings that will allow immediate enjoyment of superb audio without the need for further adjustments. If you wish to make changes to the factory default settings, a Setup Feature is provided to customize the operating settings using the Front Panel Information Display. Refer to the C2500 Front Panel Illustration on the previous page while performing the following steps.

Note: If the C2500 is currently On, proceed to step 2.

1. Press the STANDBY/ON Push-button on the Front Panel or press the  (Power) Push-button on the Remote Control to switch On the C2500. The Front Panel Display will indicate “SOURCE: TUNER, TUBE WARMUP”. Refer to figure 1A.



Figure 1A

After the Tube Warmup is completed, the C2500 will go through a brief startup initialization with the Front Panel Display indicating the last used source and volume setting, this is followed by the volume setting indication starting at zero and then increasing to the last used volume setting. Refer to figure 1B.



Figure 1B

2. Press and hold the TONE BYPASS/SETUP Push-button until the Front Panel Display indicates “C2500 V_._, S/N: _____”. The information indicated on the Front Panel Display includes the Model Number, Firmware Version and the Serial Number for this unit; Refer to figure 2A and see



Figure 2A

page 14 for additional information. At this time the LED above the TRIM Push-button will be illuminated.

3. Press the OUTPUT 2 / MENU  Push-button to select the next Setup Mode Menu item “McIntosh USB AUDIO, V_._ Firmware”. Refer to figure 2B and to page 14 for additional information.



Figure 2B

4. Next, press the OUTPUT 2 / MENU  Push-button again and the Front Panel Display will indicate “SETUP: SOURCE INPUT, TUNER: RCA”. Refer to figure 3.



Figure 3

5. To exit from the Setup Mode, press the TONE BYPASS/SETUP Push-button. The LED above the TRIM Push-button will extinguish and the Front Panel Display will revert back to its normal display. Refer to figure 1B.

Default Settings

The Default Settings Chart below indicates the Function Name, Default Setting and the Page Number for additional information.

Default Settings		
Function Name	Setting	Page No.
C2500	V_._ S/N: _____	14
McIntosh USB Audio	V_._	14
SOURCE INPUT (Reassignment)	RCA	14
SOURCE INPUT (Re-assign Input Name)	_____ >>	15
LEVEL (Trim)	0.0dB	16
POWER MODE (Auto Off)	ENABLED	16
DISPLAY (Brightness)	3	17
TUBE LIGHTS	ON	17
PASSTHRU	OFF	17
TRIG 1 Output (Action)	MAIN	18
TRIG 2 Output (Action)	MAIN	18
COMM PORT (Baud Rate)	115200	19
REMOTE (Codes)	NORM	19

Note: Setup Mode operations should be performed in the order they appear in the Setup Menu as they are interactive.



Firmware Version

The C2500 functionality is controlled by internal software that is known as Firmware. The C2500 has two different Firmwares, one is the “System Firmware” (responsible for the basic operation of the C2500) and the other known as USB Audio Firmware (responsible for the “USB Connection and Conversion” of a Digital Audio Signal from the Computer). The Version of the Firmwares in the C2500 can be identified at any time by utilizing the Setup Mode.

1. Press and hold the TONE BYPASS/SETUP Push-button until the Front Panel Display indicates “C2500 V_._, S/N: _._._.”. The number after the “V” is the firmware version and the number after the “S/N” is the serial number of the unit. Refer to figure 2A.



Figure 2A

2. Next, press the OUTPUT 2 / MENU ► Push-button again and the Front Panel Display will indicate “McIntosh USB AUDIO, V_._.”. Refer to figure 2B.



Figure 2B

3. To exit from the Setup Mode, press the TONE BYPASS/SETUP Push-button and the Front Panel Display will revert back to its normal display. Refer to figure 1B on page 13.

Reassign Source Inputs

The C2500 provides the ability to reassign the non-Phono Inputs (High Level) to either one of two Balanced Inputs or one of the four Digital Inputs.

In the first example, the CD2 Input will be reassigned from the unbalanced CD2 (RCA Jacks) to the BALANCED 1 (XLR Connector).

Notes: 1. Any one of the Default Inputs may be switched Off. If any input is switched Off, its name will no longer appear on the Front Panel Display when using the INPUT Control, nor is it accessible with the Remote Control.

2. The Phono MC (Moving Coil) and MM (Moving Magnet) Inputs are designed for connection of a turntable only and thus non-reassignable. However, the Phono Inputs may be switched Off.

3. Only one Input may be assigned at a time to a Balanced (1 & 2) or Digital (1 thru 4) Connector. If an already assigned Balanced or Digital connector is to be reassigned to a different Input, the Input currently assigned to the connector first needs to be changed. It can be set to a RCA connector or to another available Balanced or Digital connector.

1. Press and hold the TONE BYPASS/SETUP Push-button until the Setup Mode is active. Then press the OUTPUT 2 / MENU ► Push-button to select the Setup Menu item “SETUP: SOURCE INPUT, TUNER :RCA”. Refer to figure 4.



Figure 4

2. Rotate the INPUT Control until “CD2 : RCA” appears on the Front Panel Display. Refer to figure 5.



Figure 5

3. Rotate the VOLUME/ADJUST Control until “CD2 : BALANCED 1” appears on the Front Panel Display. Refer to figure 6.



Figure 6

The second example will illustrate reassigning the SRVR (Server) Input from SERVER Input (RCA Jacks) to the DIGITAL 1 Optical Input.

4. Rotate the INPUT Control until “SERVER : RCA” appears on the Front Panel Display. Refer to figure 7.



Figure 7

5. Rotate the VOLUME/ADJUST Control until “SERVER : DIGITAL 1” appears on the Front Panel Display. Refer to figure 8.



Figure 8

Record any changes made to the various inputs from the default settings in the “Input and Power Control Settings” chart for future reference.

6. To exit from the Setup Mode, press the TONE BYPASS/SETUP Push-button.

Source Input Renaming

The C2500 Default Input Names (CD, AUX, DVD, etc. as indicated on the Front Panel Display) can be customized with a different name up to nine characters long (My Phone, MCD1100, etc.). The available characters for renaming the input include the following: ! < > * , / - _ 0 1 2 3 4 5 6 7 8 9 A B C D E F G H I K L M N O P Q R S T U V W X Y Z .

In the following example, the AUX Input will be re-named to "MY-PHONE".

1. Press and hold the TONE BYPASS/SETUP Push-button until the Front Panel Display indicates the Setup Mode is active. Then rotate the INPUT CONTROL and select the Setup Menu item "SETUP: SOURCE NAME, AUX >> AUX". Refer to figure 9.



Figure 9

Note: If the AUX Input is not displayed, rotate the INPUT Control until it is displayed.

2. Press and hold in the TRIM Push-button until the character "A" of the name AUX starts flashing. Refer to figure 10.



Figure 10

3. Rotate the VOLUME/ADJUST Control until the character "M" appears. Refer to figure 11.



Figure 11

4. Rotate the INPUT Control until the character "U" starts flashing. Refer to figure 12.



Figure 12

5. Rotate the VOLUME/ADJUST Control until the character "Y" appears. Refer to figure 13.



Figure 13

6. Repeat steps 3 thru 5 until the new name of "MY-PHONE" is indicated on the Front Panel Display. Refer to figure 14.



Figure 14

7. To save the new Input Name press and hold in the TRIM Push-button until the word SAVED appears momentarily on the Front Panel Display. Refer to figure 15.



Figure 15

Note: When direct accessing the "MY-PHONE" Input using the Remote Control, press the AUX Pushbutton.

Record any changes made to the various default Input Names in the following chart for future reference.

8. To exit from the Setup Mode, press the TONE BYPASS Push-button and the Front Panel Display will revert back to its normal display.

Source Input Renaming	
Default Input Name	New Input Name
TUNER	
CD	
CD2	
DVD	
AUX	
SERVER	
USB-D/A	
PHONO MC	
PHONO MM	



Input Level Adjustment

Source Components can have slightly different volume levels resulting in the need to readjust the C2500 Volume Control when switching between different sources. The C2500 allows the adjustment of levels for each of the Source Inputs for the same relative volume. The CD and SERVER Inputs are used in the following example.

Note: The range of adjustment is ± 6 dB. The signal Level present at the RECORD OUT Jacks is unaffected by any changes in the Setup Level adjustment. The level adjustments made are retained in permanent memory. They can be changed during operation of the C2500 by performing a Trim Level, refer to page 24 for additional information.

1. Rotate the INPUT Control to select the CD Input and adjust the VOLUME Control to the desired listening level.
2. Press and hold the TONE BYPASS/SETUP Push-button until the Setup Mode is active. Then press the OUTPUT 2 / MENU ► Push-button until the Setup Menu item “LEVEL: CD 0.0dB” appears on the Front Panel Display. Refer to figure 16.



Figure 16

Note: The CD Input is serving as a reference level or choose another source frequently listened to. The Input Source should be set to a reference Level (Trim) of 0.0dB.

3. Rotate the INPUT Control until “LEVEL: SERVER 0.0dB” appears on the Front Panel Display. If necessary, rotate the VOLUME/ADJUST Control to obtain the same volume level as the CD Input by switching between the two Inputs using the INPUT Control.

4. Rotate the INPUT Control until “LEVEL: SERVER _.” appears on the Front Panel Display. The illustration in figure 17 indicates a -2.5dB decrease in the SERVER Level to match the volume level of the CD Input.



Figure 17

5. Repeat step 4 for other Inputs with component sources connected until they all have the same relative volume levels. Record any changes made to the various inputs from the default settings in the “Input and Power Control Settings” chart.
6. To exit from the Setup Mode, press the TONE BYPASS/SETUP Push-button.

Input and Power Control Settings				
Input Name	Connection Type	New Level (Trim)	Triggers	
			1	2
TUNER				
CD				
CD2				
DVD				
AUX				
SERVER				
USB-D/A				
PHONO MC				
PHONO MM				

Power Mode

The C2500 incorporates an Auto Off Feature, which automatically places the preamplifier into the Power Saving Standby/Off Mode. This occurs approximately 30 minutes after there has been an absence of audible audio signals on the selected input (on either channel) or user activity (includes changes to any of the Operation Functions such as source selection, volume adjustment, etc). If it is desirable to disable the Auto Off Feature perform the following steps:

1. Press and hold the TONE BYPASS/SETUP Push-button until the Setup Mode is active. Then press the OUTPUT 2 / MENU ► Push-button until the Setup Menu item “SETUP: POWER MODE, Auto Off: Enabled” appears on the Front Panel Display. Refer to figure 18.



Figure 18

2. Rotate the VOLUME/ADJUST Control until “SETUP: POWER MODE, Auto Off: Disabled” appears on the Front Panel Display. Refer to figure 19.



Figure 19

3. Press the TONE BYPASS/SETUP Push-button to exit the Setup Mode.

Display Brightness

The Front Panel Display Brightness may be changed from the default setting. The C2500 will remember two brightness preferences, one with the Meters Illuminated and one without Meter Illumination. For each preference there are four brightness settings for the Front Panel Display. The Display Brightness setting may be varied 1 (Dim) to 4 (Bright). Follow the steps below for reducing the Display Brightness (with the Meter Illumination On).

1. Press and hold the TONE BYPASS/SETUP Push-button until the Setup Mode is active. Then press the OUTPUT 2 / MENU ► Push-button until the Setup Menu item “SETUP: DISPLAY, Brightness: 3” appears on the Front Panel Display. Refer to figure 20.



SETUP: DISPLAY
Brightness: 3

Figure 20

2. Rotate the VOLUME/ADJUST Control until “SETUP: DISPLAY, BRIGHTNESS: 1” appears on the Front Panel Display. Refer to figure 21.



SETUP: DISPLAY
Brightness: 1

Figure 21

Note: To change the Display Brightness preference with Meter Illumination Off, first switch off the Meter Illumination (refer to page 22) and change the Display Brightness Setting.

3. To exit from the Setup Mode, press the TONE BYPASS/SETUP Push-button.

Tube Lights

To switch Off the Tube LED green illumination perform the following:

1. Press and hold the TONE BYPASS/SETUP Push-button until the Setup Mode is active. Then press the OUTPUT 2 / MENU ► Push-button until the Setup Menu item “SETUP: TUBE LIGHTS, Lights: On” appears on the Front Panel Display. Refer to figure 22.



SETUP: TUBE LIGHTS
Lights: On

Figure 22

2. Rotate the VOLUME/ADJUST Control until the Setup Menu item “SETUP: TUBE LIGHTS, Lights: Off” appears on the Front Panel Display. Refer to figure 23.



SETUP: TUBE LIGHTS
Lights: Off

Figure 23

3. Rotate the VOLUME/ADJUST Control until the Setup Menu item “SETUP: TUBE LIGHTS, Lights: Meters” appears on the Front Panel Display. Refer to figure 24



SETUP: TUBE LIGHTS
Lights: Meters

Figure 24

Note: When Tube Lights “Meters” is selected, the tube illumination goes On/Off as the meters backlight goes On/Off. Refer to page 22 “Meter Illumination”, the Trim Function controlling the Meter Backlight.

4. To exit from the Setup Mode, press the TONE BYPASS/SETUP Push-button.

Passthru

The C2500 can be part of a Multichannel Sound System for SACD, DVD-Audio and Home Theater. The Right and Left Front Channels from an Audio/Video Control Center or Surround Decoder can “Passthru” the C2500 and onto its associated Power Amplifier(s). The Setup Mode allows the activation of the Passthru Mode and the selection of the specified C2500 Input Connector to be used for the Right and Left Front Channels. In the example below, the Right and Left Front Channels from the Audio/Video Control Center will be connected to the BALANCED 2 Input Connectors on the C2500. Refer to page 4 for additional connection information.

Notes: 1. The Phono Input Connectors and Digital Input Connectors are not assignable as a Passthru Input.

2. *If Balanced Input Connectors 1 and/or 2 are already reassigned to a given Input, they will not appear in the list of available Inputs for the Passthru Mode.*
3. *When one of the RCA Inputs is selected as a Passthru Input, it is advisable to remove it from the list of available Inputs by switching it Off. Refer to “Reassign Source Inputs” starting on page 14.*

1. Press and hold the TONE BYPASS/SETUP Push-button until the Setup Mode is active. Then press the OUTPUT 2 / MENU ► Push-button until the Setup Menu item “SETUP: PASSTHRU, Source: OFF” appears on the Front Panel Display. Refer to figure 25.



SETUP: PASSTHRU
Source: OFF

Figure 25

2. Rotate the VOLUME/ADJUST Control until “SETUP: PASSTHRU, Source: BALANCED 2” appears on the Front Panel Display. Refer to figure 26.

```

SETUP: PASSTHRU
Source: BALANCED 2
    
```

Figure 26

3. Press the TONE BYPASS/SETUP Push-button to exit the Setup Mode.

Power Control Triggers 1 and 2

By default the Power Control TRIGGER 1 and TRIGGER 2 Outputs function the same as the MAIN Power Control Jack, switching On/Off with the C2500. Trigger 1 and 2 are also reassignable to activate when the ACC ON/OFF Push-buttons on the Remote Control are used or when a given Input or Inputs are selected.

EXAMPLE ONE:

The Power Control Trigger 1 Output will be set to function via the Remote Control ACC Push-buttons.

1. Press and hold the TONE BYPASS/SETUP Push-button until the Setup Mode is active. Then press the OUTPUT 2 / MENU ► Push-button until the Setup Menu item “SETUP: TRIG1 OUTPUT, Action: MAIN” appears on the Front Panel Display. Refer to figure 27.

```

SETUP: TRIG1 OUTPUT
Action: MAIN
    
```

Figure 27

2. Rotate the VOLUME/ADJUST Control until “Action: REMOTE” appears. Refer to figure 28.

```

SETUP: TRIG1 OUTPUT
Action: REMOTE
    
```

Figure 28

3. Press the TONE BYPASS/SETUP Push-button to exit the Setup Mode.

EXAMPLE TWO:

This example will use selection of the Tuner Input to switch the Trigger 1 Output On.

4. Press and hold the TONE BYPASS/SETUP Push-button until the Setup Mode is active. Then press the OUTPUT 2 / MENU ► Push-button until the Setup Menu item “SETUP: TRIG1 Output, Action: MAIN” appears on the Front Panel Display. Refer to figure 27.

5. Rotate the VOLUME/ADJUST Control until “Action: SOURCE” appears. Refer to figure 29.

```

SETUP: TRIG1 OUTPUT
Action: SOURCE
    
```

Figure 29

6. Then press the OUTPUT 2 / MENU ► Push-button until the Setup Menu item “SETUP: TRIG1 OUTPUT, Source: _____ OFF” appears on the Front Panel Display. Refer to figure 30.

```

SETUP: TRIG1 OUTPUT
Source: _____ OFF
    
```

Figure 30

- Notes:
1. The Input Source selected before entering the Setup Mode will be display in step six/figure 30.
 2. By default all the Source Inputs are set to Off.
 3. Any combination of Source Inputs from one to all may be assigned to either Trigger (1 or 2) or both Triggers.

7. Rotate the INPUT Control to select the Tuner as the source. Refer to figure 31.

```

SETUP: TRIG1 OUTPUT
Source: Tuner OFF
    
```

Figure 31

8. Rotate the VOLUME/ADJUST Control until “Source: Tuner ON” appears. Refer to figure 32.

```

SETUP: TRIG1 OUTPUT
Source: Tuner ON
    
```

Figure 32

9. Press the TONE BYPASS/SETUP Push-button to exit the Setup Mode.

Comm Port Baud Rate

The C2500 may be remotely controlled from other equipment connected to the Rear Panel RS232C connector. The speed at which the C2500 communicates (8 bit, no parity and 1 stop bit) with other equipment is adjustable from 9,600 bits per second to 115,200 bits per second. To change from the default speed of 115,200 bits per second, perform the following steps:

1. Press and hold the TONE BYPASS/SETUP Push-button until the Setup Mode is active. Then press the OUTPUT 2 / MENU ► Push-button until the Setup Menu item “SETUP: COMM PORT BAUD RATE: 115200” appears on the Front Panel Display. Refer to figure 33.



SETUP: COMM PORT
BAUD RATE: 115200

Figure 33

2. Rotate the VOLUME/ADJUST Control to select the desired speed.
3. Press the TONE BYPASS/SETUP Push-button to exit the Setup Mode.

Remote Control Codes

The Remote Control included with the C2500 utilizes the NORMal McIntosh Control Codes. The Second Set of Control Codes the C2500 will respond to is referred to as the ALternate Codes. The ALternate Codes are used when the C2500 is used in the same location as another McIntosh Preamplifier and/or A/V Control Center. This will prevent the Remote Control from affecting the operation of both units at the same time. To activate the Remote Control ALternate Codes perform the following steps:

1. Press and hold the TONE BYPASS/SETUP Push-button until the Setup Mode is active. Then press the OUTPUT 2 / MENU ► Push-button until the Setup Menu item “SETUP: REMOTE, CODES: NORM” appears on the Front Panel Display. Refer to figure 34.



SETUP: REMOTE
CODES: NORM

Figure 34

2. Rotate the VOLUME/ADJUST Control until “CODES: ALT” appears on the Front Panel Display. Refer to figure 35.



SETUP: REMOTE
CODES: ALT

Figure 35

3. Press the EQ BYPASS/SETUP Push-button to exit the Setup Mode.
4. To change the C2500 Remote Control to the ALternate Codes perform the following steps:
 - A. Press the “Mc” Push-button.
 - B. Press the SET Push-button until the “Mc” Push-button flashes twice.
 - C. Press the 3, 2, 4, 2 and 9 Push-buttons within 5 seconds.

- D. The “Mc” Push-button flashes twice.

Note: To reset the Remote Control to normal codes perform steps A and B then enter 3, 2, 4, 2 and 8 for step C.

5. Press the VOLUME UP/DOWN Push-button on the Remote Control to verify proper operation.

How to Operate the C2500

Power On and Off

The Red LED above the STANDBY/ON Push-button lights to indicate the C2500 is in Standby mode. To switch ON the C2500, press the STANDBY/ON Push-button on the Front Panel or press the (Power) Push-button on the Remote Control to switch On the C2500. Refer to figures 50, 51A, 51B, 52 and 53.



Figure 51A



Figure 51B



Figure 52

The Front Panel Display will indicate “SOURCE: TUNER , TUBE WARMUP”. After the Tube Warmup is completed, the C2500 will go through a brief startup initialization with the Front Panel Display indicating the last used source and volume setting, this is followed by the volume setting indication starting at zero and then increasing to the last used volume setting. To switch OFF the C2500 press the STANDBY/ON Push-button on the Front Panel or the OFF Push-button on the Remote Control.

Note: For an explanation of the Remote Control Push-button functions, refer to pages 10 and 11.

Source Selection

Rotate the INPUT Control to select the desired source or press the appropriate push-button on the Remote Control. Refer to figures 50 and 53.

Volume Control

Rotate the Front Panel VOLUME Control or use the

VOLUME Up▲ or Down▼ Push-buttons on the Remote Control for the desired listening level. Refer to figures 50 and 53.

Trim Functions

The C2500 has ten different Trim Selections with Adjustments. The Trim Selections include Balance, Bass, Treble, Trim Level, Phono Cartridge Loading, Meter Backlight, External Processor, Tone Control, Mono/Stereo Mode and Digital Audio Display Info. The Trim Settings are stored in memory independently for each Input Source Selected, except the Meter Illumination and Digital Audio Display settings of On or Off, which are the same for all inputs.

Note: Selection and Adjustment of all Trim Functions may be performed using the Front Panel TRIM, OUTPUT 1/ OUTPUT 2 / ◀ MENU ▶ Push-buttons together with the VOLUME/ADJUST Control. The Remote Control TRIM Push-Button together with the LEVEL + / - Push-button may also be used. Refer to figures 50 and 53.

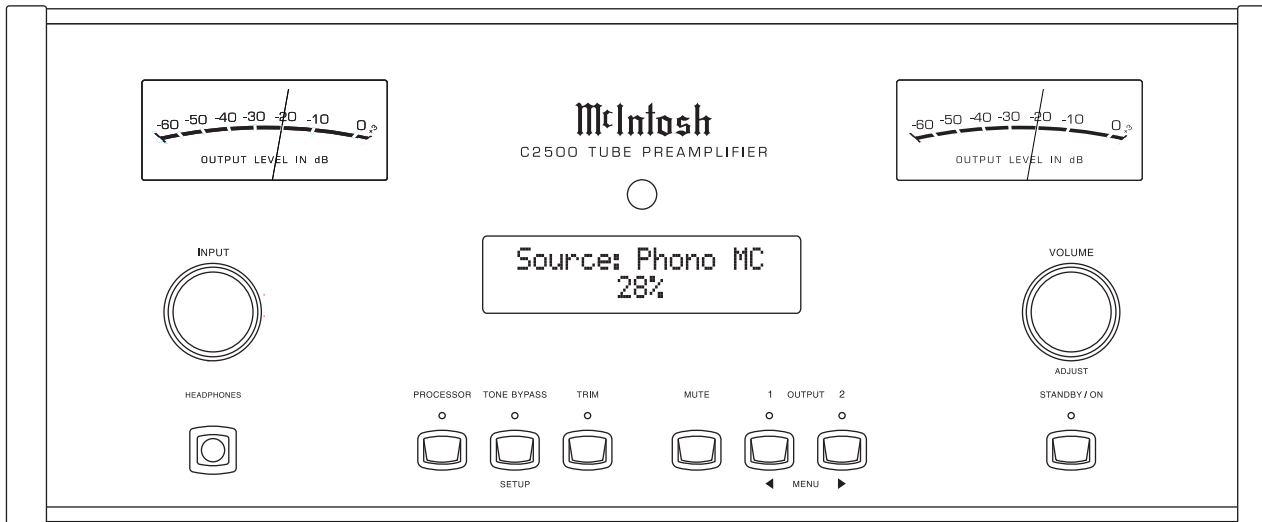

Figure 50

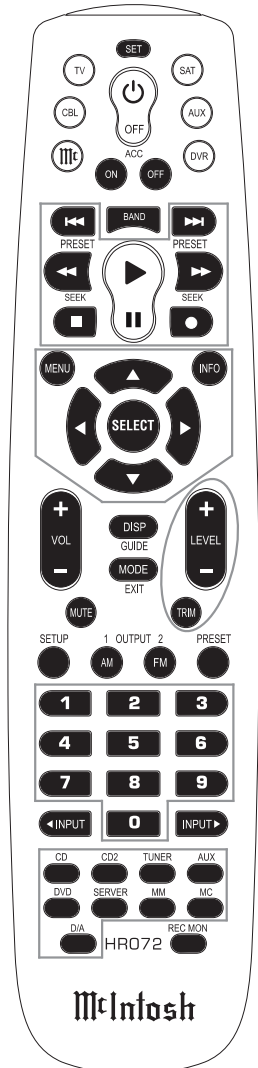

Figure 53

BALANCE

Listening balance varies with different program sources, room acoustics and listening positions relative to the Loudspeakers. Use the Balance (Trim Function) as needed to achieve approximately equal listening volume levels in each Loudspeaker. To adjust the Balance perform the following:

1. Press the TRIM Push-button repeatedly on the Remote Control until “BALANCE 0 dB” appears on the Front Panel Display. Refer to figure 54.



Figure 54

Note: The Front Panel TRIM Push-button together with the OUTPUT 1/ OUTPUT 2 / ◀ MENU ▶ Push-buttons may also be used.

2. Press the LEVEL +/- Push-buttons on the Remote Control or rotate the VOLUME/ADJUST Control to emphasize the Right Channel (refer to figure 55) or the Left Channel (refer to figure 56).



Figure 55



Figure 56

The Front Panel Display indicates the Balance changes in steps from 0 to 50dB. After approximately 5 seconds the Front Panel Display returns to indicate the Source Selection and Volume Level. To verify the Balance setting without changing it, use the TRIM Push-button and select Balance.

BASS

The Intensity of the Low Frequencies in the music can be increased or decreased by using the Trim Select and Trim Adjust Controls. To make an adjustment perform the following:

1. Press the TRIM Push-button repeatedly on the Remote Control until “BASS 0 dB” appears on the Front Panel Information Display. Refer to figure 57.



Figure 57

2. Press the LEVEL +/- Push-buttons to increase (refer to figure 58) or decrease (refer to figure 59) the volume level of the low frequencies.



Figure 58



Figure 59

The Front Panel Display indicates the Bass changes in steps from +12dB to -12dB. After approximately 5 seconds the Display returns to indicate the Source Selection and Volume Level.

TREBLE

The Intensity of the High Frequencies in the music can be increased or decreased by using the Trim Select and Trim Adjust Controls. To make an adjustment perform the following:

1. Press the TRIM Push-button repeatedly on the Remote Control until “TREBLE 0 dB” appears on the Front Panel Display. Refer to figure 60.



Figure 60

2. Press the LEVEL +/- Push-buttons to increase (refer to figure 61) or decrease (refer to figure 62) the volume level of the high frequencies.



Figure 61



Figure 62

The Front Panel Display indicates the Treble changes in steps from +12dB to -12dB. After approximately 5 seconds the Display returns to indicate the Source Selection and Volume Level.



How to Operate the C2500, con't

TRIM LEVEL

The Trim Level adjustments allow for making fine adjustments to the previously performed Trim Level Adjustments (refer to “Input Level Adjustment” on page 16 for additional information). To make a fine adjustment to the currently selected Input Source perform the following:

1. Select “TRIM LEVEL” as indicated on the Front Panel Display. Refer to figures 50, 53 and 63.



Figure 63

2. Adjust the Trim Level to -2.5dB. Refer to figure 64.



Figure 64

After approximately 5 seconds the Front Panel Display returns to indicate the Source Selection and Volume Level.

METER ILLUMINATION

The C2500 Front Panel Meter Illumination may be switched On or Off by performing the following:

1. Select “METER BACKLIGHT, Lights: On” as indicated on the Front Panel Display. Refer to figures 50, 53 and 65.



Figure 65

2. Switch On or Off the Meter Illumination. Refer to figure 66.



Figure 66

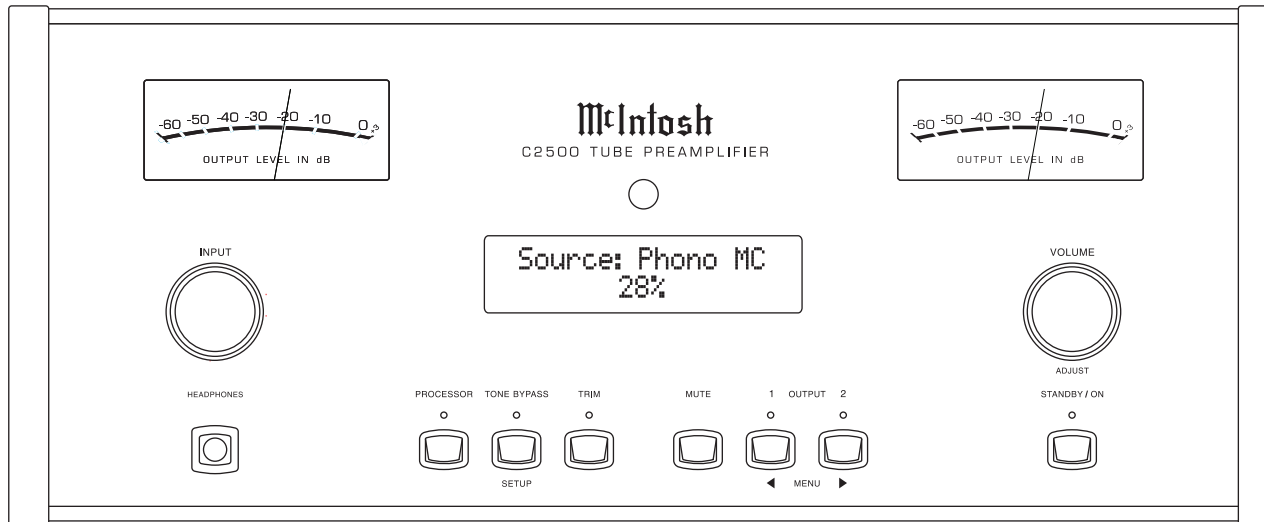

Figure 50

After approximately 5 seconds the Front Panel Display returns to indicate the Source Selection and Volume Level.

Notes: 1. For information on how the Front Panel Display Brightness can change with the Meter Illumination On/Off Setting, refer to page 17 Setup “Display Brightness”.

2. Meter Illumination of recent McIntosh Power Amplifiers will also switch On/Off when connected to the C2500 via a power control cable.

EXTERNAL PROCESSOR

The C2500 Preamplifier has a Processor Loop for connecting an external sound processor. The Processor may be assigned to be active for only those Inputs desired. To activate the Processor Loop and assign it to Inputs, perform the following steps:

- Notes: 1. If the Processor is set active for a given Input and no external Processor is connected to the C2500, no sound will be heard when selected.*

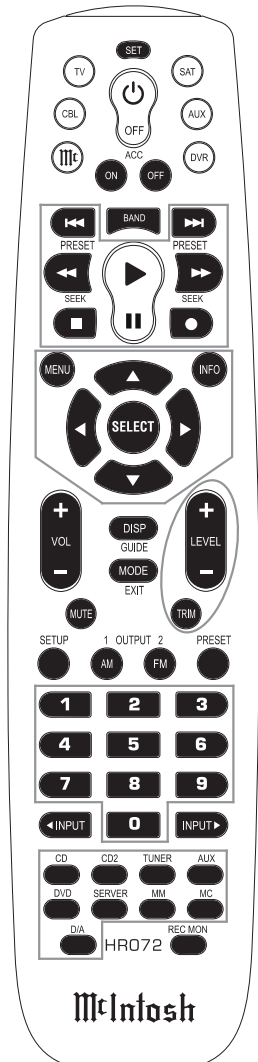

Figure 53

2. The audio signal present at the RECORD OUT Jacks is unaffected by the external processor loop.

1. Select "EXTERNAL PROCESSOR, _____: Bypass" as indicated on the Front Panel Display. Refer to figure 67.



Figure 67

2. Set the external Processor Loop to be either enabled or bypassed. Refer to figure 68.



Figure 68

After approximately 5 seconds the Front Panel Display returns to indicate the Source Selection and Volume Level.

TONE CONTROL

With the Tone Bypass active, the Bass and Treble Settings for the currently selected Input Source are electronically bypassed and the LED above the TONE BYPASS Push-button will illuminate. When the Tone Bypass is switched Off, the previous settings for Bass and Treble will be restored (default setting). To activate Tone Bypass perform the following:

1. Select the desired Input by using the direct access Input Push-button on the Remote Control.
2. Press the TRIM Push-button on the Remote Control until "TONE CONTROL, _____: ENABLE" appears on the Front Panel Display. Refer to figure 69.



Figure 69

3. Press TRIM LEVEL +/- Push-button to activate the Tone Bypass. Refer to figure 70.



Figure 70

After approximately 5 seconds the Display returns to indicate the Source Selection and Volume Level.

MONO/STEREO MODE

By default the Stereo Mode is active for all Input Sources however, any Input Source may be assigned to Mono Mode. To change Stereo Mode to Mono for a given Input Source, perform the following steps:

Note: The audio signal present at the RECORD OUT Jacks is unaffected by the Stereo/Mono setting.

1. Select the desired Input Source.
2. Select "MONO/STEREO MODE, _____: Stereo" as indicated on the Front Panel Display. Refer to figure 71.

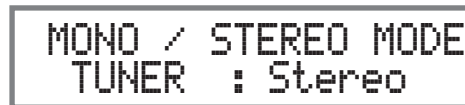

Figure 71

3. Set the "MONO/STEREO MODE" for either STEREO or MONO. Refer to figure 72.



Figure 72

After approximately 5 seconds the Front Panel Display returns to indicate the Source Selection and Volume Level.

DIGITAL AUDIO DISPLAY

By default the Digital Audio Display is switched Off. To display information about the type of digital signal present when any one of the five digital inputs is selected, perform the following steps:

1. Select one of the Inputs assigned to an active digital source.

Note: The USB-D/A Input may also be selected when the C2500 is connected to a computer.

2. Select "DIGITAL AUDIO, Display Info: Off" as indicated on the Front Panel Display. Refer to figure 73.



Figure 73

3. Set the "DIGITAL AUDIO, Display Info" to On. Refer to figure 74.



Figure 74

After approximately 5 seconds the Front Panel Display will return to indicate the Source Selection, Volume Level and now with the addition of Digital Information. Refer to figure 75.



Figure 75

PHONO ADJUSTMENTS

When the Phono MC or Phono MM Input is selected an additional TRIM SELECT FUNCTION becomes available for adjustment. Perform the following steps

How to Operate the C2500, con't

to make the Phono Trim Adjustments:

1. Select either the Phono MM or Phono MC Source Input.
2. Select “PHONO CARTRIDGE, Moving Coil 400 Ohm” or “PHONO CARTRIDGE, Moving Magnet 50pF” as indicated on the Front Panel Display. Refer to figures 76 and 77.

PHONO CARTRIDGE
Moving Coil: 400 Ohm

Figure 76

PHONO CARTRIDGE
Moving Magnet: 50pF

Figure 77

3. Set the desired phono cartridge loading value (Ohms for a Moving Coil Cartridge or Capacitance for a Moving Magnet Cartridge) that comes closest to the Phono Cartridge Makers recommended value.

After approximately 5 seconds the Front Panel Display returns to indicate the Source Selection and Volume Level.

Processor Loop

Press the Front Panel PROCESSOR Push-button to activate the C2500 Processor Loop for the currently selected Input Source. The LED above the PROCESSOR Push-button will illuminate. Refer to figure 50. The C2500 remembers for each selected Input whether the Processor Loop is active. To remove the Processor Loop for the currently selected Input Source press the PROCESSOR Push-button.

- Notes:*
1. If the Processor Loop is active and no external Processor is connected to the C2500, sound will not be heard.
 2. The audio signal present at the RECORD OUT Jacks is unaffected by the external processor loop.

Tone Bypass

Press the Front Panel Tone BYPASS Push-button to remove the C2500 Tone Circuitry from the signal path for the currently selected Input Source. The LED above the TONE BYPASS Push-button will illuminate. Refer to figure 50. The C2500 remembers for each selected Input whether the Tone Control Circuitry is deactivated. To reactivate the Tone Control for the currently selected Input Source press the TONE BYPASS Push-button.

Note. The audio signal present at the RECORD OUT Jacks is unaffected by the Tone Control Circuitry.

Trim

Press the Front Panel TRIM Push-button to activate the C2500 Trim Functions. Use the Front Panel OUTPUT 1/ OUTPUT 2 / ◀ MENU ▶ Push-buttons to select the desired Trim Function and then use the VOLUME/ADJUST Control to vary or make changes. Refer to figure 50. The Remote Control TRIM and LEVEL +/- Push-buttons may also be used. The LED above the TRIM Push-button will illuminate during Trim selection and adjustment. Approximately 4 seconds after Trim Function Selection and/or adjustments have stopped the C2500 will switch off the Trim Mode.

Mute

Press the MUTE Push-button, on the C2500 Front Panel or on the Remote Control, to Mute the Audio at the OUTPUTS Connectors (Main, Output 1, Output 2) except the REC OUTPUT Jacks. The Front Panel Display will indicate the Input Source Name with the word MUTE in place of the actual volume setting. Refer to figure 78.

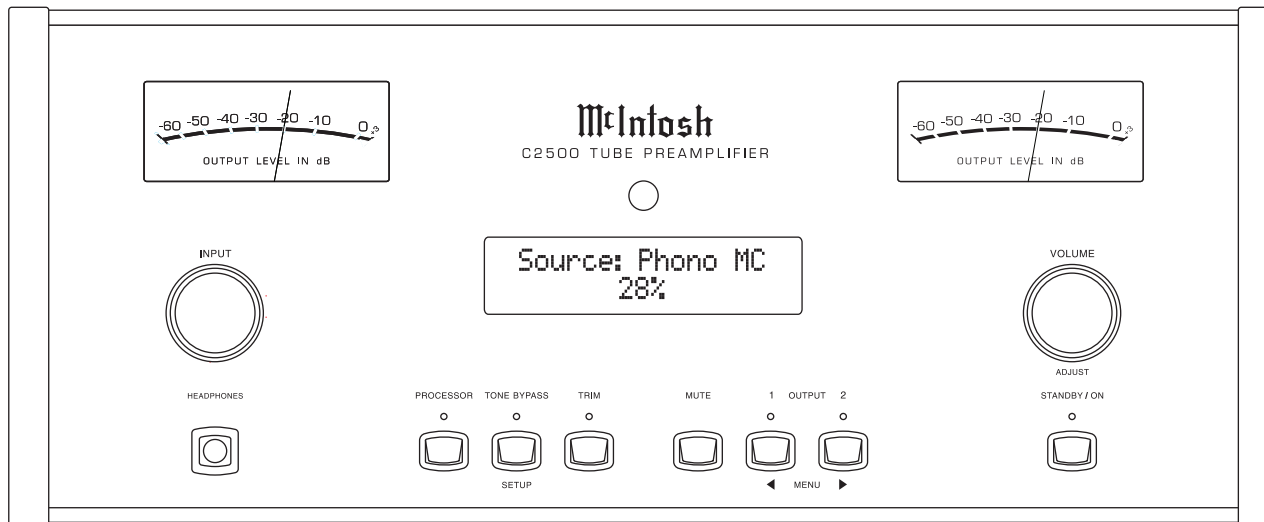

Figure 50



Figure 78

Pressing the Mute Push-button a second time or adjusting the volume control (either the Front Panel or Remote Control) will un-mute the C2500. If the Front Panel MUTE Push-button is pressed for at least 4 seconds, the C2500 will mute the Audio at the OUTPUTS Connectors, however listening with headphones will resume. Refer to figure 79.



Figure 79

When the MUTE Push-Button is pressed a second time the OUTPUTS Connectors and Headphones are muted. Refer to figure 80.



Figure 80

When pressing the Mute Push-button again for 4 seconds, audio is available at all OUTPUT Connectors and the headphones.

Output 1 and 2

Press the Front Panel OUTPUT 1 / OUTPUT 2 Push-button or use the Remote Control and press the SETUP/BLUE Push-button followed by the OUTPUT 1 / OUTPUT 2 Push-button to send audio to separate Power Amplifiers connected to the rear panel OUTPUT 1 or 2 Jacks. It also activates the POWER CONTROL OUTPUT 1 / OUTPUT 2 Jacks on the rear panel of the C2500. To stop the Audio and Power

Control Signals from going to the separate Power Amplifiers, press the same Push-button(s) a second time.

Output Meters

The C2500's Output Meters indicate the Output Level in Decibels (dB) available at the MAIN and OUTPUT 1 & 2 Jacks to drive Power Amplifiers. Refer to figure 81.

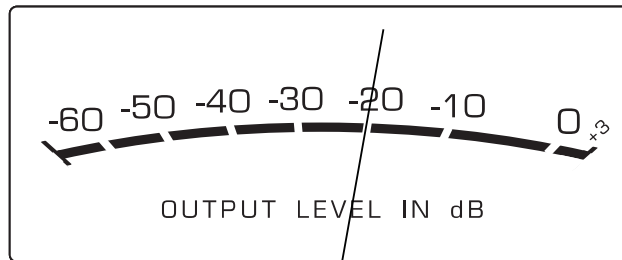

Figure 81

The Meters are calibrated in dB (decibels) and respond to all the peaks contained in the musical information. A meter reading of 0dB indicates the C2500 is delivering its rated output.

Passthru

When the C2500 is connected together with a McIntosh Multichannel A/V Control Center or Surround Decoder and has the PASSTHRU MODE activated, it will automatically turn-on when the A/V Control Center or Surround Decoder is turned On. It will indicate on the Front Panel Display "PASSTHRU". Refer to figure 82.



Figure 82

The C2500 OUTPUT 1 / OUTPUT 2 Front Panel Push-buttons are active when in the Passthru Mode.

The other Front Panel Controls and Push-buttons are deactivated as long as the Passthru Mode is active

Headphones Jack

Connect a pair of dynamic headphones to the Headphones Jack with a 1/4" (6.4mm) stereo phone type plug for private listening. Press OUTPUT 1 and/or 2 Push-buttons to mute the Loudspeakers.

Note: The Headphone Output is optimized for impedances ranging from 20 to 600 ohms.

How To Make a Recording

1. Select the desired signal source you wish to record by using the Front Panel INPUT Control or the appropriate Source Push-button on the Remote Control.
2. Adjust the record level using the recorder level control and proceed with the recording process.
3. Listen to the playback of the program source just recorded by selecting the Input Source connected to the recorder component output.

Optical and Digital Inputs

When a Digital Input (Optical or Coaxial Connection) on the C2500 is selected the Front Panel Display will indicate when a signal is present "2CH PCM". Refer to figure 83. During the time there is no Digital Signal present the display will indicate "SILENT". Refer to figure 84.



Figure 83



Figure 84

How to Operate the C2500, con't

USB Input Operation with a Computer

The C2500 USB-D/A Input provides the capability to playback music from a computer, when the computer is connected to the rear panel USB D/A connector. The C2500 USB Input is compatible with both PC Computers using Microsoft® Windows® (XP with Service Pack 3, Vista with Service Pack 1 and Windows 7) and the Apple® Macintosh® Computers using OS-10.6 with the latest update.

When using a PC Computer with Windows, a special McIntosh USB Audio Software Driver needs to be installed on the PC Computer. The driver needs to be installed before connecting the C2500 USB Input to an USB Port on the computer.

Note: If an Apple Macintosh computer is used with the C2500, no additional driver is required.

The McIntosh USB Audio Windows Driver and Installation and Operation Guide are available for download from the McIntosh Web Site:

<http://www.mcintosh-labs.com/us/support/Pages/Manuals.aspx>

Under “Product Category” select Preamplifiers and under “Model Number” select C2500, then click on “Select”. When the C2500 Information appears, download the “McIntosh Audio Windows Driver Installation and Operation Guide” and “McIntosh USB Audio Windows Driver V_ . _”. Follow the instructions in the Guide and after the USB Driver is installed, connect the C2500 to the PC Computer.

Note: When computer application programs and various computer hardware components conform

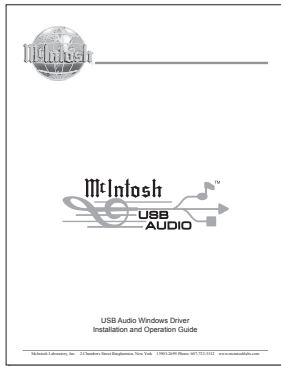

to the Microsoft® Windows® and Apple® Macintosh® standards they should also work well when used in conjunction with the C2500 USB Input. If you are experiencing difficulty with a specific computer hardware component or computer application program, contact the manufacturer of the product.

The C2500 Preamplifier Front Panel Display will indicate the Bit and Sampling Rate of the incoming digital signal. Refer to figure 85.



Figure 85

Reset of Microprocessors

In the unlikely event the controls of the C2500 stop functioning, the microprocessors can be reset by performing the following:

1. Press and hold the STANDBY/ON Push-button for approximately ten seconds and then release.
2. To switch the C2500 back On press the On STANDBY/ON Push-button.

Note: This can be performed with the C2500 On or in the Standby Mode.

Resetting the C2500 to default settings

If it becomes desirable to reset all the adjustable settings (Setup and Trim Settings) to the factory default values, perform the following steps:

1. Press both the PROCESSOR and OUTPUT 2 Push-buttons until the Front Panel Display indicates “FACTORY RESET”. Refer to figure 86,



Figure 86

then release the two push-buttons. Several seconds later the Front Panel Display will indicate “FACTORY RESET, -COMPLETE-” and the C2500 will switch Off. Refer to figure 87.



Figure 87

2. Press the STANDBY/ON Push-button and the C2500 will resume operation.





FREQUENCY RESPONSE
 ±0, -0.5dB from 20Hz to 20kHz

TOTAL HARMONIC DISTORTION
 0.08%, Maximum from 20Hz to 20kHz

RATED OUTPUT
 2.5V Unbal Main, 1, 2 Outputs
 5.0V Bal Main, 1, 2 Outputs

SENSITIVITY FOR RATED OUTPUT
 High level - 450mV Unbal, 900mV Bal
 Phono MM - 4.5mV
 Phono MC - 0.45mV

C2500
TUBE PREAMPLIFIER
 Precision Performance By **McIntosh**
 McIntosh Laboratory Inc., Binghamton, New York, USA

SIGNAL TO NOISE RATIO
 High level - 100dB
 Phono - 88dB

DIGITAL INPUT SAMPLE RATES
 SPDIF - 16-Bit, 24-Bit - 32kHz to 96kHz
 USB - 16, 24, 32-Bit - 32kHz to 192kHz

DIGITAL TO ANALOG CONVERSION
 32-Bit/192kHz All Modes

HEADPHONE LOAD IMPEDANCE
 20 Ohms TO 600 Ohms

Specifications

Frequency Response

+0, -0.5dB from 20Hz to 20,000Hz

+0, -3dB from 10Hz to 100,000Hz

Total Harmonic Distortion

0.08% from 20Hz to 20,000Hz

Rated Output (Main)

2.5V Unbalanced, 5V Balanced

Maximum Output

8V RMS Unbalanced, 16V RMS Balanced

Sensitivity (for rated output)

High Level, 450mV unbalanced, 900mV balanced

Phono MM, 4.5mV

Phono MC, 0.45mV

Signal To Noise Ratio (A-Weighted)

High Level, 100dB below rated output

Phono MM, 75dB below 5mV input

Phono MC, 75dB below 0.5mV input

Input Impedance

High Level, 22K ohms unbalanced, 44k ohms balanced

Phono MM, 47K ohms; 50 to 750pF, in 50pF steps

Phono MC, 25, 50, 100, 200, 400 or 1,000 ohms;

100pF

Maximum Input Signal

High Level, 8V Unbalanced, 16V Balanced

Phono MM, 80mV

Phono MC, 8mV

Tone Controls

Voltage Gain

High Level to Record Output: 0dB

High Level to Main Output: 15dB

Phono MM to Record Output: 40dB

Phono MC to Record Output: 60dB

Output Impedance

220 ohms

Headphone Impedance

20 ohms to 600 ohms

Digital Input Sample Rates

Optical: 16Bit, 24Bit - 32kHz to 96kHz

Coaxial: 16Bit, 24Bit - 32kHz to 96kHz

USB: 16Bit, 24Bit, 32Bit - 32kHz to 192kHz

Power Control and Trigger Output

12VDC, 25mA

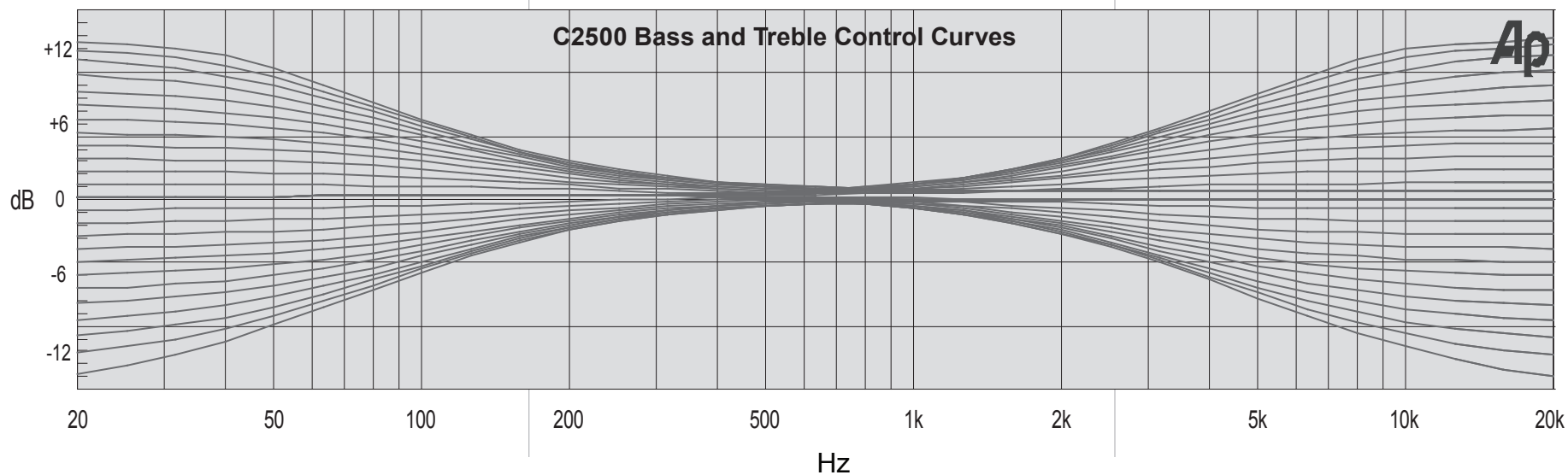



General Specifications

Power Requirements

Field AC Voltage conversion of the C2500 is not possible. The C2500 is factory configured for one of the following AC Voltages:

100 Volts, 50/60Hz at 50 watts

110 Volts, 50/60Hz at 50 watts

120 Volts, 50/60Hz at 50 watts

220 Volts, 50/60Hz at 50 watts

230 Volts, 50/60Hz at 50 watts

240 Volts, 50/60Hz at 50 watts

Standby Power, less than 0.5 watts

Note: Refer to the rear panel of the C2500 for the correct voltage.

Overall Dimensions

Width is 17-1/2 inches (44.45cm)

Height is 7-5/8 inches (19.37cm) including feet

Depth is 18 inches (45.72cm) including the Front Panel, Knobs and Cables

Weight

30.5 pounds (13.8 kg) net, 46 pounds (20.9 kg) in shipping carton

Shipping Carton Dimensions

Width is 27 inches (68.6cm)

Height is 14 inches (35.6cm)

Depth is 25 inches (63.5cm)



Packing Instructions

In the event it is necessary to repack the equipment for shipment, the equipment must be packed exactly as shown below. It is very important that the four plastic feet are attached to the bottom of the equipment. This will ensure the proper equipment location on the bottom pad. Failure to do this will result in shipping damage.

Use the original shipping carton and interior parts only if they are all in good serviceable condition. If a shipping carton or any of the interior part(s) are needed, please call or write Customer Service Department of McIntosh Laboratory. Refer to page 3. Please see the Part List for the correct part numbers.

Quantity	Part Number	Description
1	033888	Shipping carton only
4	033887	End cap
1	033697	Inside carton only
1	034414	Top pad (foam)
1	034301	Bottom pad
4	017937	Plastic foot
4	400159	#10-32 x 3/4" screw
4	404080	#10-7/16" Flat washer

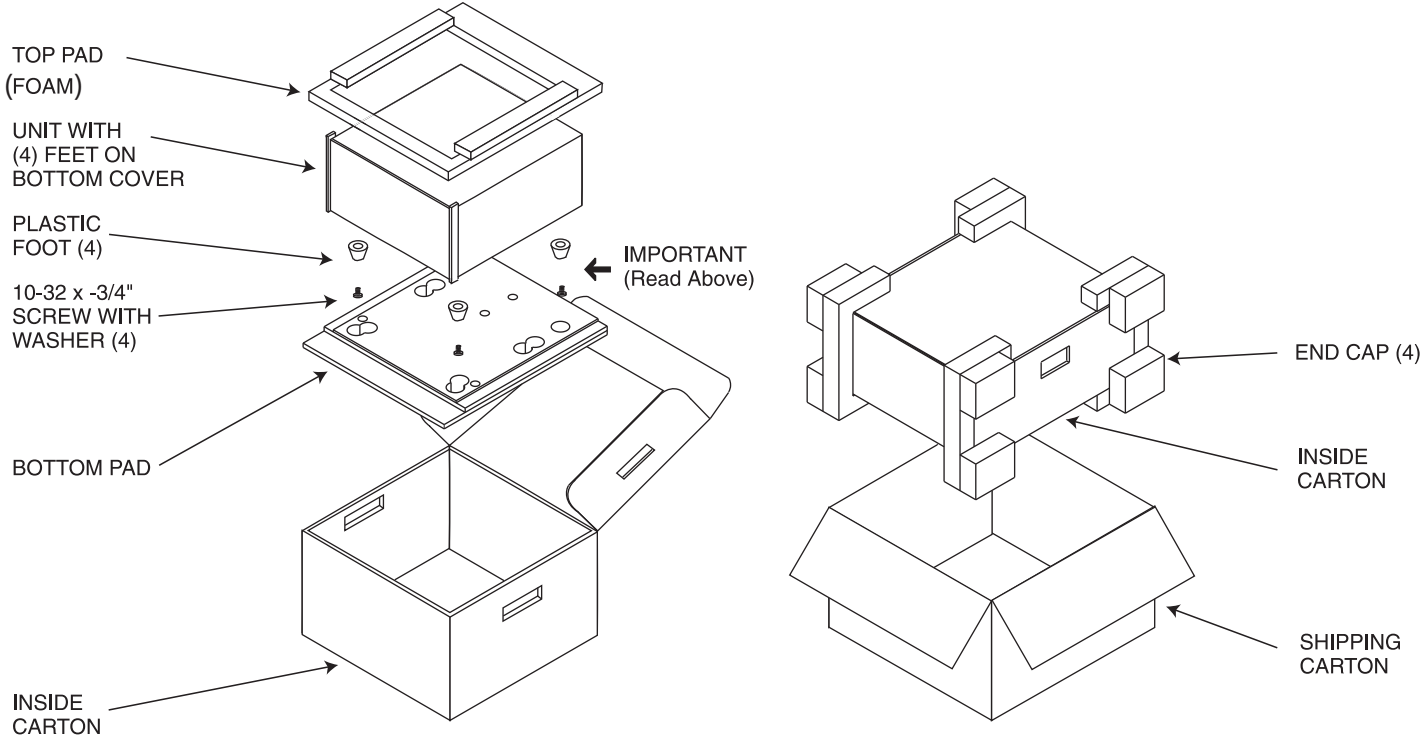



McIntosh Laboratory, Inc.
2 Chambers Street
Binghamton, NY 13903
www.mcintoshlabs.com

The continuous improvement of its products is the policy of McIntosh Laboratory Incorporated who reserve the right to improve design without notice.
Printed in the U.S.A.