



McIntosh Laboratory, Inc. 2 Chambers Street Binghamton, New York 13903-2699 Phone: 607-723-3512 www.mcintoshlabs.com

MCT450
SACD/CD Transport
Owner's Manual





The lightning flash with arrowhead, within an equilateral triangle, is intended to alert the user to the presence of uninsulated "dangerous voltage" within the product's enclosure that may be of sufficient magnitude to constitute a risk of electric shock to persons.

WARNING - TO REDUCE RISK OF FIRE OR ELECTRICAL SHOCK, DO NOT EXPOSE THIS EQUIPMENT TO RAIN OR MOISTURE.



AVIS RISQUE DE CHOC ELECTRIQUE - NE PAS OUVRIR.

NO USER-SERVICEABLE PARTS INSIDE. REFER SERVICING TO QUALIFIED PERSONNEL.

The exclamation point within an equilateral triangle is intended to alert the user to the presence of important operating and maintenance (servicing) instructions in the literature accompanying the appliance.

To prevent the risk of electric shock, do not remove cover or back. No user-serviceable parts inside.

CAUTION - Invisible Laser Radiation when open. DO NOT stare into the beam or view directly with optical instruments. Use of controls or adjustments or performance of procedures other than those specified in the Owners Manual may result in Hazardous Radiation Exposure.

**LUOKAN 1 LASERLAITE
KLASS 1 LASER APPARAT**

VAROITUS! Laitteen käyttäminen muulla kuin tassa käyttöohjeessa mainitulla tavalla saattaa altistaa käyttäjän turvallisuusluokan 1 ylittävälle näkymättömälle lasersäteilylle.

WARNING! Om apparaten används på annat sätt än i denna bruksanvisning specificerats, kan användaren utsättas för osynlig laserstrålning, som överstiger gränsen för laserklass 1.

This product incorporates an embedded CLASS 3R Laser (IEC60825-1).

CAUTION: CLASS 3R INVISIBLE LASER RADIATION WHEN OPEN, DO NOT STARE INTO THE BEAM OR VIEW DIRECTLY WITH OPTICAL INSTRUMENTS. AVOID DIRECT EYE EXPOSURE.

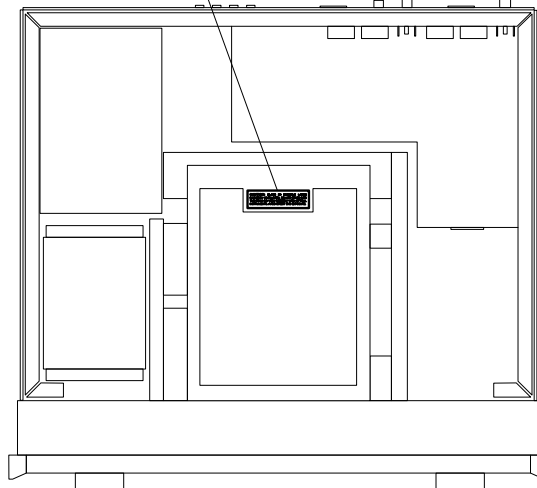

**CLASS 1
LASER PRODUCT**

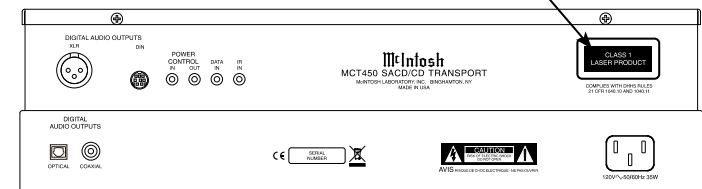

IMPORTANT SAFETY INSTRUCTIONS!

PLEASE READ THEM BEFORE OPERATING THIS EQUIPMENT.

1. Read these instructions.
2. Keep these instructions.
3. Heed all warnings.
4. Follow all instructions.
5. Do not use this apparatus near water.
6. Clean only with a dry cloth.
7. Do not block any ventilation openings. Install in accordance with the manufacturer's instructions.
8. Do not install near any heat sources such as radiators, heat registers, stoves, or other apparatus (including amplifiers) that produce heat.
9. Do not defeat the safety purpose of the polarized or grounding-type plug. A polarized plug has two blades with one wider than the other. A grounding type plug has two blades and a third grounding prong. The wide blade or the third prong are provided for your safety. If the provided plug does not fit into your outlet, consult an electrician for replacement of the obsolete outlet.
10. Protect the power cord from being walked on or pinched particularly at plugs, convenience receptacles, and the point where they exit from the apparatus.
11. Only use attachments/accessories specified by the manufacturer.

12. Use only with the cart, stand, tripod, bracket, or table specified by the manufacturer, or sold with the apparatus. When a cart is used, use caution when moving the cart/apparatus combination to avoid injury from tip-over.
13. Unplug this apparatus during lightning storms or when unused for long periods of time.
14. Refer all servicing to qualified service personnel. Servicing is required when the apparatus has been damaged in any way, such as power-supply cord or plug is damaged, liquid has been spilled or objects have fallen into the apparatus, the apparatus has been exposed to rain or moisture, does not operate normally, or has been dropped.
15. Do not expose this equipment to dripping or splashing and ensure that no objects filled with liquids, such as vases, are placed on the equipment.
16. To completely disconnect this equipment from the a.c. mains, disconnect the power supply cord plug from the a.c. receptacle.
17. The mains plug of the power supply cord shall remain readily operable.
18. Do not expose batteries to excessive heat such as sunshine, fire or the like.
19. Connect mains power supply cord only to a mains socket outlet with a protective earthing connection.



Table of Contents

Safety Instructions	2-3
Table of Contents	3
Thank You and Please Take a Moment.....	4
Technical Assistance and Customer Service	4
General Information	4
Connector and Cable Information	4-5
Disc Information	5
Introduction.....	5
Performance Features	5
Dimensions	6
Installation	7

Connections:

Rear Panel Connections	8
Connections using Digital DIN Output	10
Connection Diagrams (Separate Sheet)	Mc1A
Connections using Digital Coaxial, Optical or XLR	11
Connection Diagram (Separate Sheet).....	Mc1B

Front Panel Features:

Front Panel Displays and Push-buttons	12
Front Panel Information Display.....	13

Remote Control:

Remote Control Push-buttons.....	14
How to use the Remote Control.....	15

Operation:

How to Operate the MCT450.....	16-21
--------------------------------	-------

Additional Information:

Specifications.....	22
Packing Instruction.....	23



Thank You

Your decision to own this McIntosh MCT450 SACD/CD Transport ranks you at the very top among discriminating music listeners. You now have “The Best.” The McIntosh dedication to “Quality,” is assurance that you will receive many years of musical enjoyment from this unit.

Please take a short time to read the information in this manual. We want you to be as familiar as possible with all the features and functions of your new McIntosh.

Please Take A Moment

The serial number, purchase date and McIntosh Dealer name are important to you for possible insurance claim or future service. The spaces below have been provided for you to record that information:

Serial Number: _____

Purchase Date: _____

Dealer Name: _____

Technical Assistance

If at any time you have questions about your McIntosh product, contact your McIntosh Dealer who is familiar with your McIntosh equipment and any other brands that may be part of your system. If you or your Dealer wish additional help concerning a suspected problem, you can receive technical assistance for all McIntosh products at:

McIntosh Laboratory, Inc.
2 Chambers Street
Binghamton, New York 13903
Phone: 607-723-1545
Fax: 607-724-0549

Customer Service

If it is determined that your McIntosh product is in need of repair, you can return it to your Dealer. You can also return it to the McIntosh Laboratory Service Department. For assistance on factory repair return procedure, contact the McIntosh Service Department at:

McIntosh Laboratory, Inc.
2 Chambers Street
Binghamton, New York 13903
Phone: 607-723-3515
Fax: 607-723-1917

General Information

1. For additional connection information, refer to the owner’s manual(s) for any component(s) connected to the MCT450 SACD/CD Transport.
2. The Super Audio Compact Discs Audio Signals are available at the Digital Audio Output DIN Connector. Compact Discs Audio Signals are available at the Digital Audio Output XRL, Optical, Coaxial and DIN Connectors.
3. The IR Input, with a 3.5mm mini phone jack, is configured for non-McIntosh IR sensors such as a Xantech Model HL85BK Kit. Use a Connection Block such as a Xantech Model ZC21 when two or more IR sensors need to be connected to the MCT450.
5. When discarding the unit, comply with local rules or regulations. Batteries should never be thrown away or incinerated but disposed of in accordance with the local regulations concerning battery disposal.
6. For additional information on the MCT450 and other McIntosh Products please visit the McIntosh Web Site at www.mcintoshlabs.com.



Connector and Cable Information

XLR Connectors (Digital Audio)

Below is the Pin configuration for the XLR Balanced Digital Audio Connectors on the MCT450. Refer to the diagram for connection:

- PIN 1: Shield/Ground
- PIN 2: + Signal
- PIN 3: - Signal

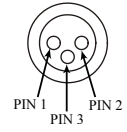

Note: When connecting to the MCT450 Digital XLR Input and Output connectors it is important to use a twisted pair shielded cable.

Data and IR Input Port Connectors

The MCT450 Data In Port receives Remote Control Signals. A 1/8 inch stereo mini phone plug is used for connection. The IR Ports also use a 3.5mm stereo mini phone plug and allow the connection of other brand IR Receivers to the MCT450.

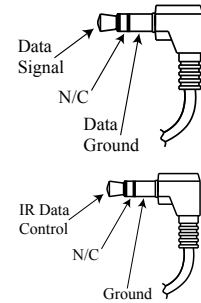

Power Control Connector

The MCT450 Power Control Input receives an On/Off signal from +5 to +12 volts. The Power Control Output will then send out a +12 volt Output Signal with a total current up to 50mA. An additional connection is for controlling the illumination of the Power Output Meters. The 3.5mm stereo mini phone plug connects to a McIntosh Preamplifier or A/V Control Center Power Control Output.

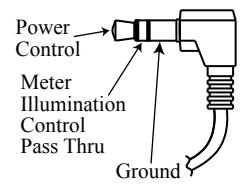

Digital DIN Cable

The Digital DIN Cable supplied with the MCT450 is a McIntosh Designed Custom Cable. A substitute cable will not work with the MCT450 and McIntosh Pre-amplifiers with a Digital DIN Connector. If it should become necessary to replace the supplied Digital DIN cable, order part number 171923 from the McIntosh Parts Department.



Disc Information

1. The MCT450 is designed to play round Compact Discs; do not try other shapes or possible damage may occur.
2. The MCT450 SACD/CD Transport is designed to play all industry standard "Redbook" CD Audio Discs as indicated by the  Symbol. It will also play most CD-R, CD-RW and Dual Discs, however some recorded discs may not be able to play due to the condition of the recording or manufacturing.
3. Disc with tracks recorded with MP3 and WMA Formats will playback on the MCT450 when the writing software used to create them conforms to the ISO9660 Level 1 standard.
4. Several of the SACD performance features available on the MCT450 are active only if the SACD Disc includes the supporting encoded information.
5. The Audio from playback of SACD Two Channel Layer and Multichannel Layer Discs is available at the MCT450 Digital Audio Output DIN Connector. The Digital Audio XRL, Optical, Coaxial Outputs will be muted during SACD Playback.

6. The PCM (Pulse Code Modulation) Digital Signal, is the standard for Audio CD Discs and is available at all Digital Audio Output Connectors on the MCT450. Discs with WAV and MP3 file formats are converted internally to a PCM Digital Signal.

Introduction

The McIntosh MCT450 SACD/CD Transport offers the latest in audio technology, providing state of the art reproduction of audio discs. A full complement of performance features allows for the enjoyment of the SACD and CD Disc Audio Formats. The advanced mechanical design of the transport ensures many years of smooth trouble free operation.

Performance Features

• Twin Laser Pickup

The MCT450 incorporates two laser elements, with different wavelengths, that are focused through one lens assembly. This unique design allows reading both the CD and Super Audio Compact Disc (SACD) Discs Formats.

• Advanced Transport

The MCT450 has a new transport with a Die Cast Tray. It has the latest in advanced digital servo for faster, quieter and accurate operation. The Disc Audio Data is read at twice the normal rate insuring better disc tracking and error correction processing.

• Advanced Digital DIN Output

A unique Digital DIN Output connects to McIntosh Preamplifiers with a Digital DIN Connector for the purist possible sound quality.

• Digital Audio Outputs

The MCT450 Digital Outputs include Coaxial, Optical, XRL and DIN Connections.

• Power Control and Full Function Remote Control

The Power Control Input Connection switches the MCT450 On/Off with other McIntosh Components in a system. The Remote Control with illuminated push-buttons provides complete control of the MCT450 operating functions.

• Multi-Function Front Panel Display

The MCT450 Front Panel display indicates the current disc playback status.

• Special Power Supply

The Linear Power Supply has both a special R-Core Power Transformer and Multiple Regulators to ensure stable noise free operation even though the power line varies.

• Glass Front Panel and Super Mirror Chassis

The MCT450 has the famous McIntosh Illuminated Glass Front Panel and Stainless Steel Super Mirror Finish Chassis. These highly durable materials will ensure the pristine beauty of the MCT450 will be retained for many years.

• Fiber Optic Solid State Front Panel Illumination

The Illumination of the Front Panel is accomplished by the combination of custom designed Fiber Optic Light Diffusers and extra long life Light Emitting Diodes (LEDs). This provides even Front Panel Illumination and is designed to ensure the pristine beauty of the MCT450 will be retained for many years.



Dimensions

The following dimensions can assist in determining the best location for your MCT450.

Front View of the MCT450

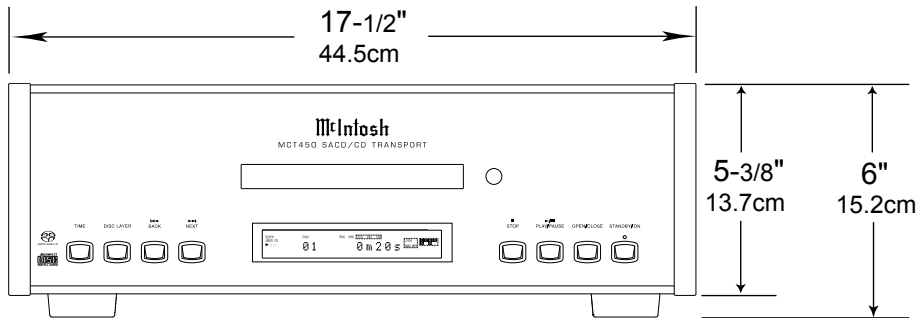

Rear View of the MCT450

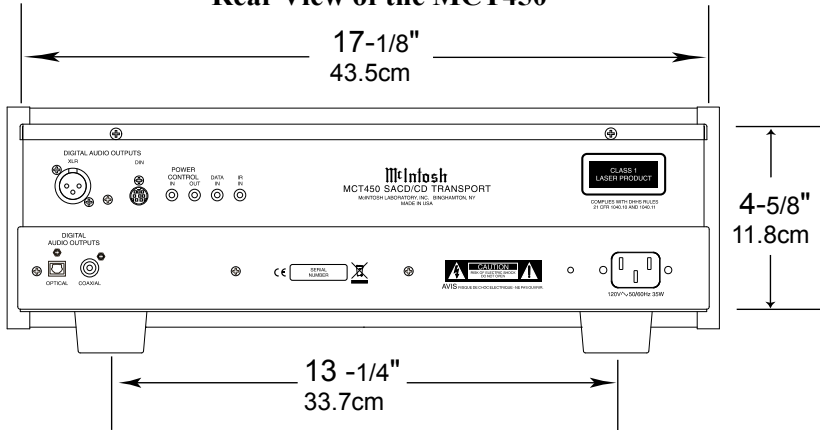

Side View of the MCT450

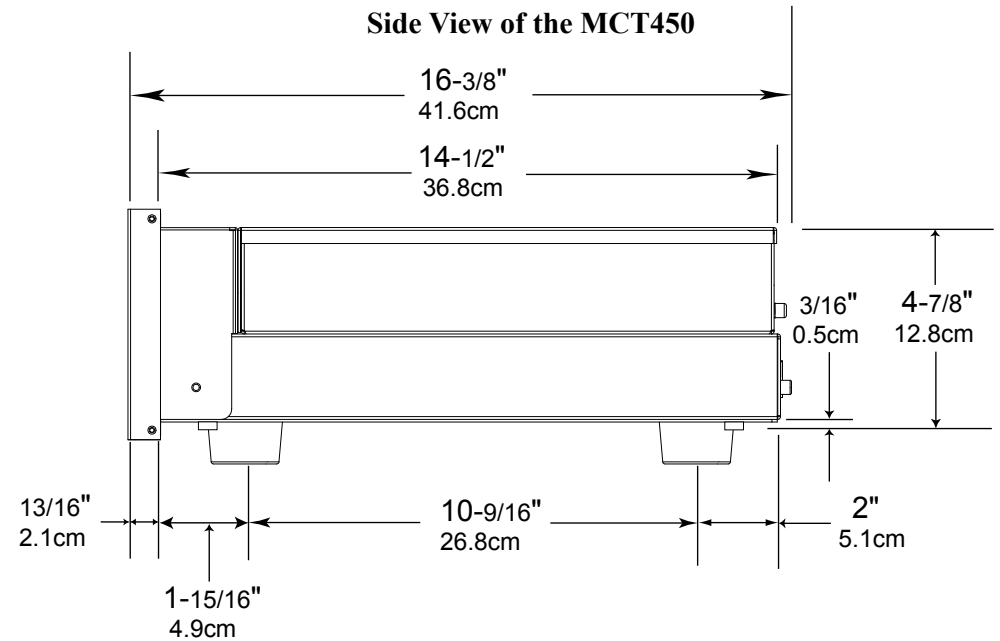

Installation

The MCT450 can be placed upright on a table or shelf, standing on its four feet. It also can be custom installed in a piece of furniture or cabinet of your choice. The four feet may be removed from the bottom of the MCT450 when it is custom installed as outlined below. The four feet together with the mounting screws should be retained for possible future use if the MCT450 is removed from the custom installation and used free standing. The required panel cutout, ventilation cutout and unit dimensions are shown.

Always provide adequate ventilation for your MCT450. Cool operation ensures the longest possible operating life for any electronic instrument. Do not install the MCT450 directly above a heat generating component such as a high powered amplifier. If all the components are installed in a single cabinet, a quiet running ventilation fan can be a definite asset in maintaining all the system components at the coolest possible operating temperature.

A custom cabinet installation should provide the following minimum spacing dimensions for cool operation.

Allow at least 2 inches (5.1cm) above the top, 2 inches (5.1cm) below the bottom and 1 inch (2.5cm) on each side of the SACD/CD Transport, so that airflow is not obstructed. Allow 17 inches (43.2cm) depth behind the front panel. Allow 1-1/8 inch (2.9cm) in front of the mounting panel for knob clearance. Be sure to cut out a ventilation hole in the mounting shelf according to the dimensions in the drawing.

**MCT450 Front Panel
Custom Cabinet Cutout**

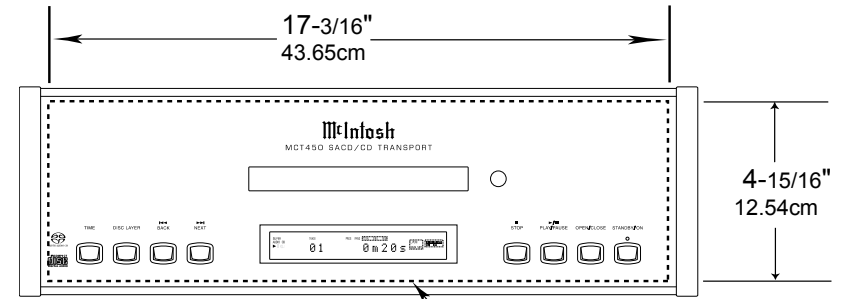

Cutout Opening for Custom Mounting

**MCT450 Side View
in Custom Cabinet**

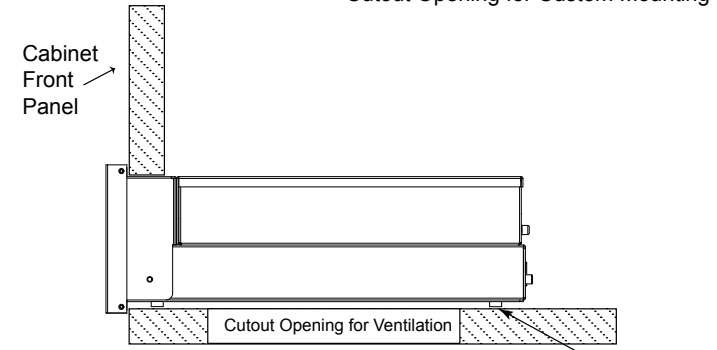

**MCT450 Bottom View
in Custom Cabinet**

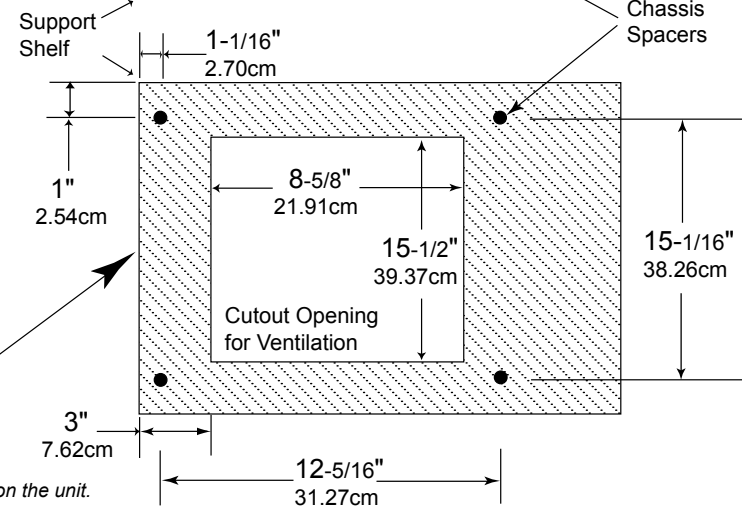

Note: Center the cutout horizontally on the unit.
For purposes of clarity, the above illustration is not drawn to scale.



XLR DIGITAL AUDIO OUTPUT sends a PCM Digital Signal to a Preamplifier with internal D/A Converter to decode the signal into analog audio

DIN DIGITAL AUDIO OUTPUT sends PCM or SACD Digital Signal to a Preamplifier with internal D/A Converter to decode the signal into analog audio

DATA IN receives control data from a McIntosh Control Center

Connect the MCT450 power cord to a live AC outlet. Refer to information on the back panel of your MCT450 to determine the correct voltage for your unit

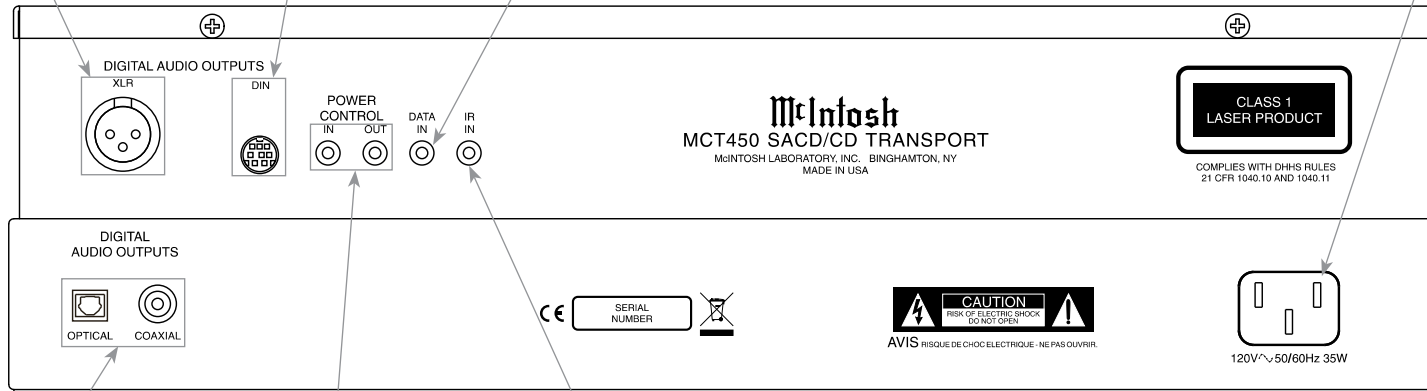

POWER CONTROL IN receives turn-on signals from a McIntosh component and POWER CONTROL OUT sends turn-on signals on to another McIntosh Component

OPTICAL and COAXIAL DIGITAL AUDIO OUTPUTS send a PCM Digital Audio Signal to a Preamplifier or an A/V Control Center to decode the signal into analog audio

IR IN for connecting an IR Receiver

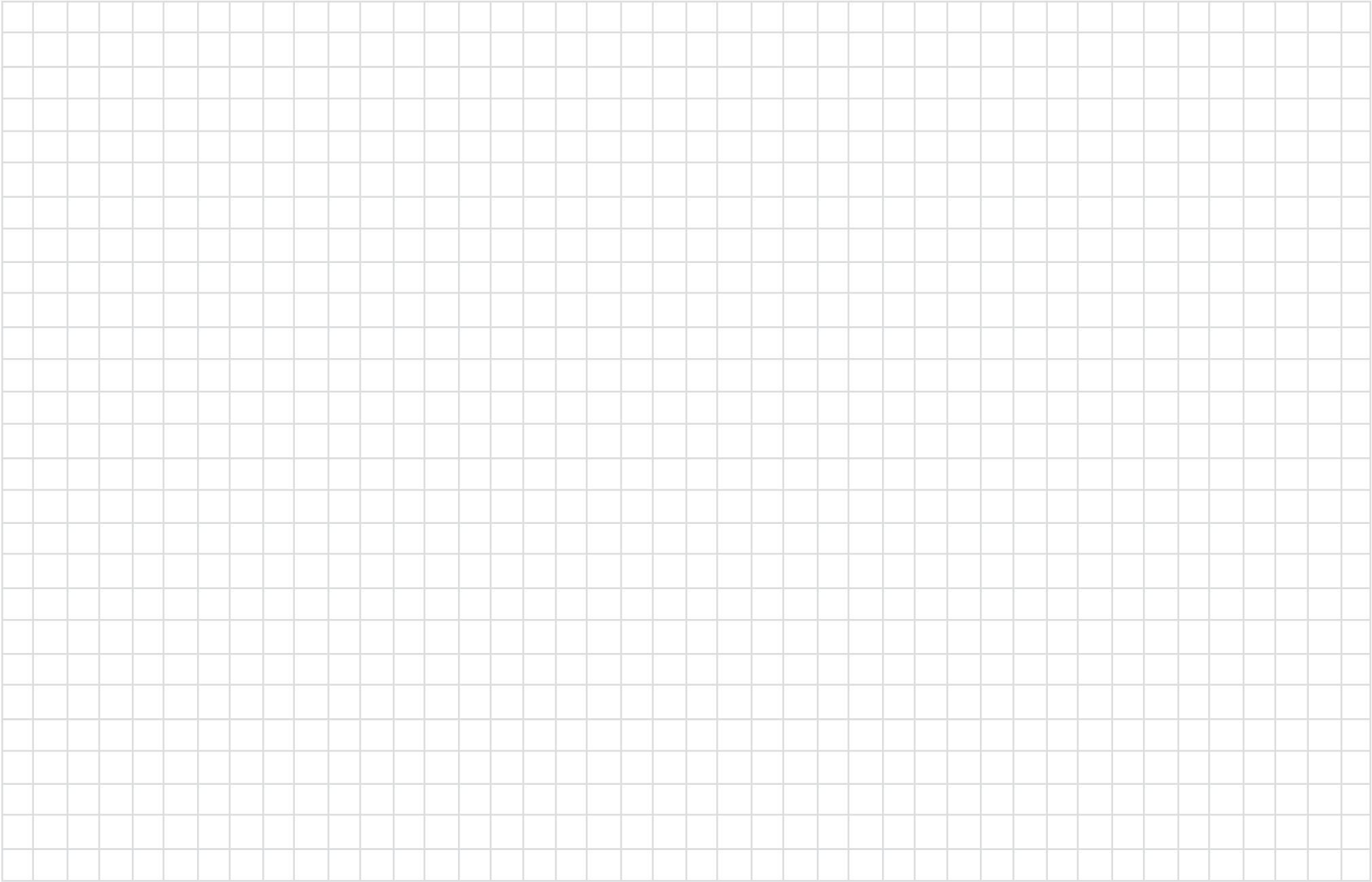



Connections using Digital DIN Output

The MCT450 Digital Audio DIN Output Connector outputs PCM and SACD Digital Disc Signals when connected to a compatible McIntosh Preamplifier. Power Control provides the ability to be remotely switched On/Off from a McIntosh Preamplifier or A/V Control Center via the Power Control connection.

The MCT450 Data Port Connection allows for the remote operation of basic functions using the Preamplifier Remote Control. When the MCT450 is used with a McIntosh D150 Digital Preamplifier, the Remote Control supplied with the D150 will also control the basic MCT450 transport functions. With an external sensor connected to the MCT450, remote control operation is possible from another room and/or when the MCT450 is located in a cabinet with the doors closed.

The connection instructions below, together with the MCT450 Connection Diagram located on the separate folded sheet “Mc1A, is an example of a typical audio system. Your system may vary from this, however the actual components would be connected in a similar manner. For additional information refer to “Connector and Cable Information” on page 4.

Power Control Connections:

1. Connect a Control Cable from the Preamplifier Power Control (or CNTRL) Jack to the POWER CONTROL IN Jack on the McIntosh MCT450 SACD/CD Transport.
2. Optionally, connect a Control Cable from the MCT450 SACD/CD Transport POWER CONTROL OUT Jack to additional McIntosh components with Power Control In Jack.

Data Control Connections:

3. When a connection on the Preamplifier is available, connect a Control Cable from the Preampli-

fier CD Data Port Jack to the McIntosh MCT450 SACD/CD Transport DATA IN Jack.

Sensor Connections:

4. Optionally, connect an IR Sensor to the McIntosh MCT450 SACD/CD Transport IR IN Jack.

Digital Audio Connections:

5. Connect the supplied Digital DIN Cable from the McIntosh MCT450 SACD/CD Transport DIGITAL AUDIO OUTPUT DIN connector to the Digital DIN Input Connector on the on the Preamplifier.

Note: When the Digital DIN Output Connection between the MCT450 and Digital DIN Audio Input on a Preamplifier is used, no additional Digital Audio Connections are necessary. The Digital DIN Connection is for all types of disc based Digital Signals.

AC Power Cords Connections:

6. Connect the McIntosh MCT450 SACD/CD Transport AC Power Cord to a live AC outlet.

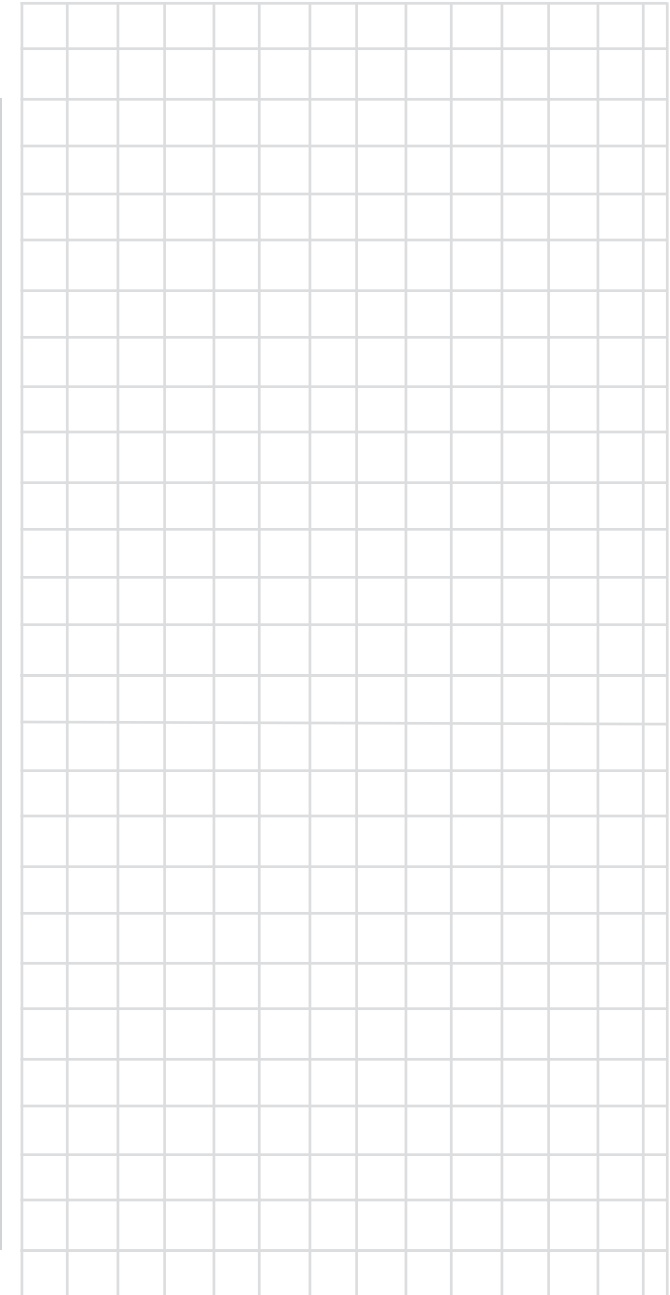

Connections using Digital Coaxial, Optical or XLR

The MCT450 may be connected to a preamplifier via the Coaxial, Optical or XLR Digital Balanced Output Connections for playback of discs with PCM Digital Signals.

Note: For playback of SACD Discs, the Digital DIN Output Connection between the MCT450 and Digital DIN Audio Input on a Preamplifier is required.

The connection instructions below, together with the MCT450 Connection Diagram located on the separate folded sheet “Mc1B, is an example of a typical audio system. Your system may vary from this, however the actual components would be connected in a similar manner. For additional information refer to “Connector and Cable Information” on page 4.

Power Control Connections:

1. Connect a Control Cable from the Preamplifier Power Control (or CNTRL) Jack to the POWER CONTROL IN Jack on the McIntosh MCT450 SACD/CD Transport.
2. Optionally, connect a Control Cable from the MCT450 SACD/CD Transport POWER CONTROL OUT Jack to additional McIntosh components with Power Control In Jack.

Data Control Connections:

3. When a connection on the Preamplifier is available, connect a Control Cable from the Preamplifier CD Data Port Jack to the McIntosh MCT450 SACD/CD Transport DATA IN Jack.

Digital Audio Connections:

4. Connect a fiber Optical Cable from the MCT450 SACD/CD Transport DIGITAL AUDIO OUTPUT, OPTICAL to the Optical Digital Input on the Preamplifier.

Note: A Coaxial or XRL Digital Balanced Connection may be used instead of the Optical Connection.

AC Power Cords Connections:

5. Connect the McIntosh MCT450 SACD/CD Transport AC Power Cord to a live AC outlet.



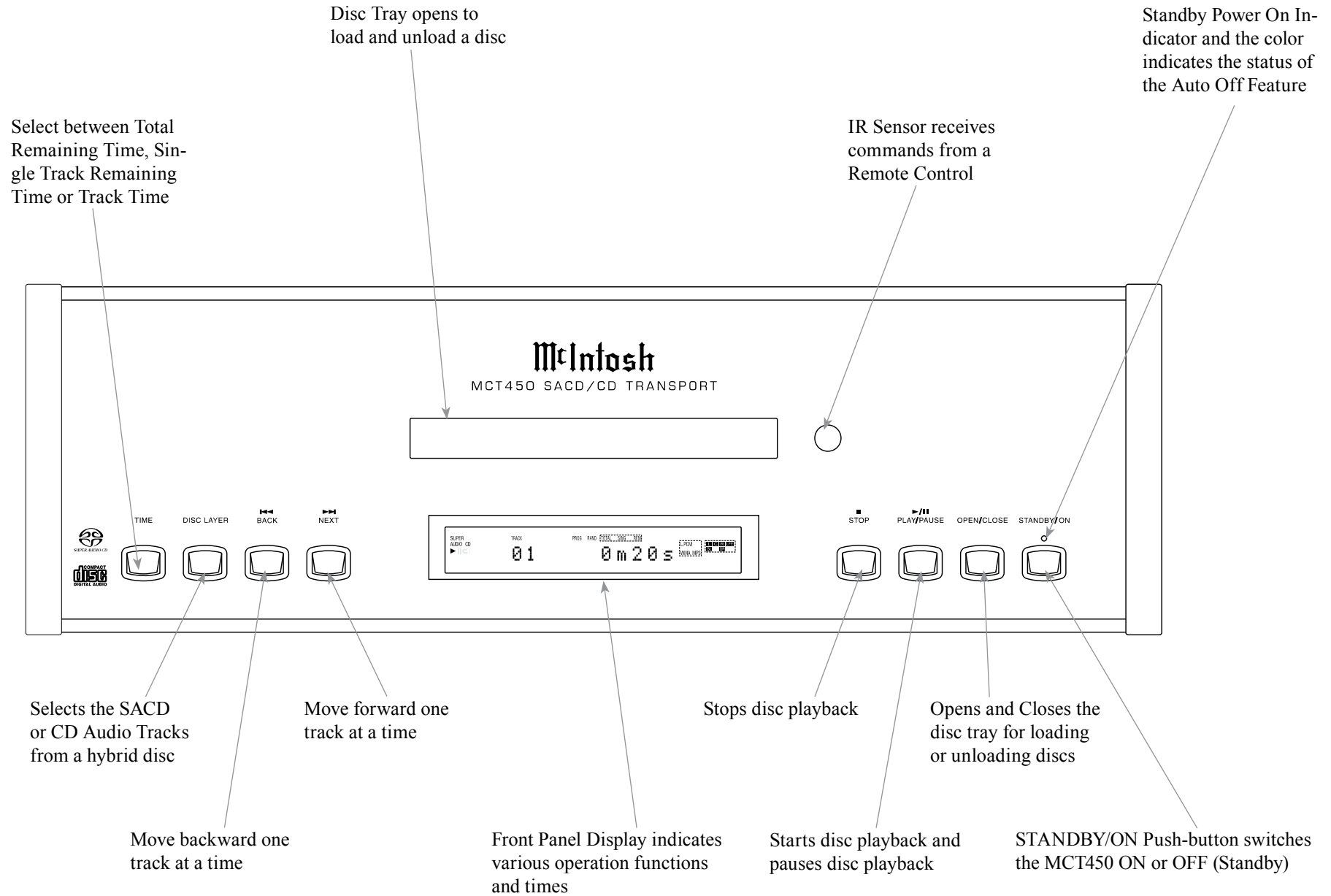

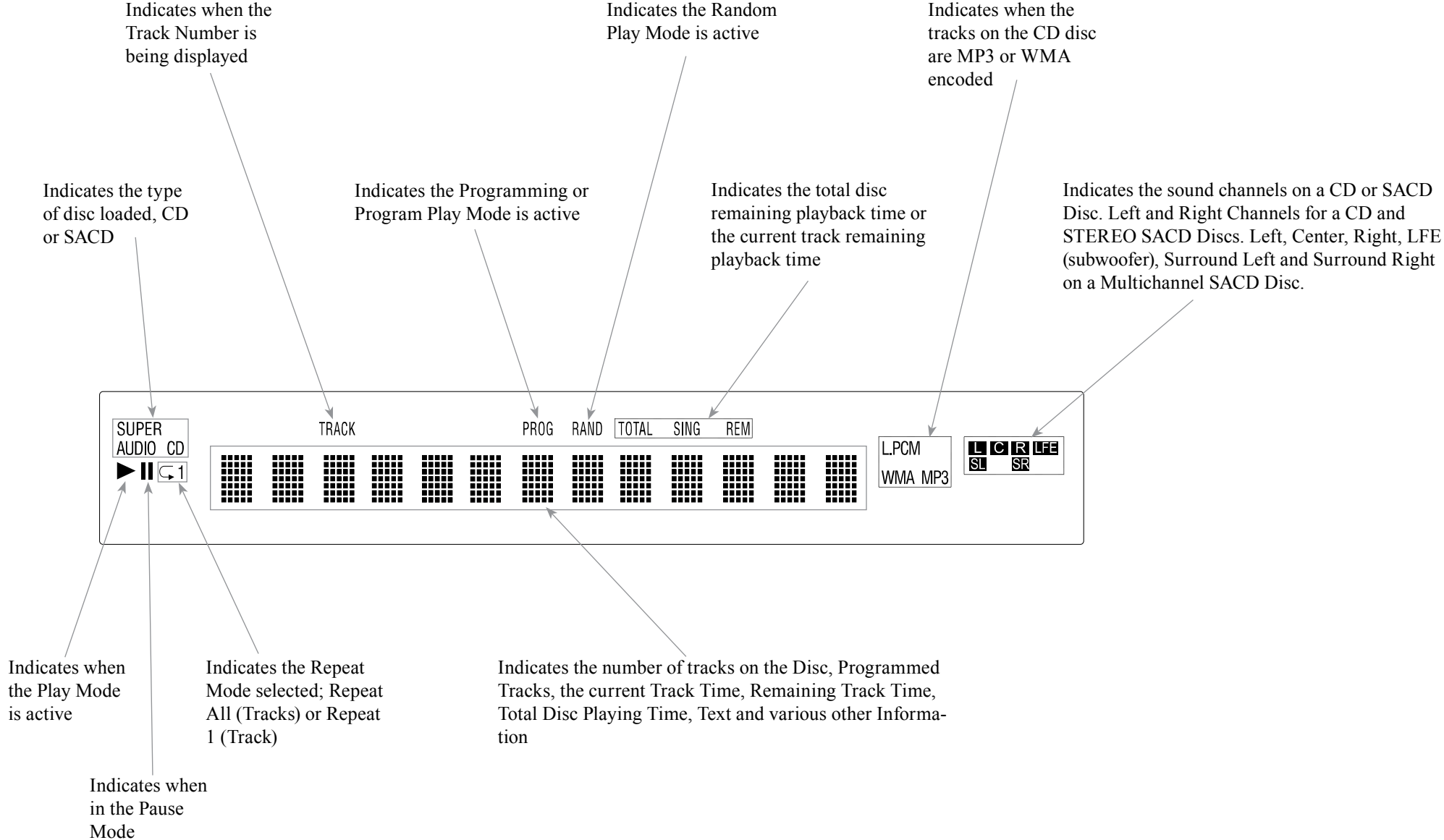



SHIFT push-button with LED Indicators used to select a push-button function with white or gold color nomenclature

Push-buttons 2, 4, 6 and 8 used for navigating up, down, left, right through tracks/folders

Use to CLEAR the last programmed track

Access the TEXT Display Mode when playing a SACD Disc containing the information

Use to select various disc information, including time, on the Front Panel DISPLAY. It is also used to cancel the text display mode on a SACD Disc

Use to select the SACD or CD Tracks from a hybrid disc for playback

Press Back to play the Previous Selection. Also used to select one of various repeat modes

Press once to PLAY, a second time to PAUSE and a third time to RESUME playback. Also used to activate random playback of the tracks on a SACD or CD disc

Press to FAST-REVERSE thru the current selection

Momentarily press to Power ON or OFF

Use to select disc tracks or any numbered operation

Push-button 5 used to Enter the track/folder indicated on the McIntosh Front Panel Display

Use to direct access tracks 10 and above

Selects Disc MODE or Folder Mode for navigating and selection of music on a CD-ROM Disc

Press to play the NEXT Selection

Press to FAST-FORWARD thru the current selection

Press to STOP disc playback

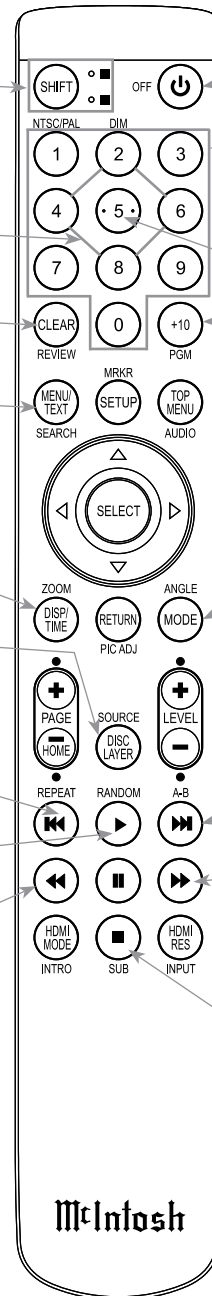

Note: The Remote Control Push-buttons not identified are for use with other McIntosh Products

How to use the Remote Control

The Remote Control is capable of performing most Operating Functions for the MCT450 SACD/CD Transport.

If at any time the Player seems unresponsive to the desired Remote Control Command, it may be necessary to select the color of the push-button nomenclature for the desired command. This is accomplished by first pressing the SHIFT Push-button to select gold, as indicated by the LED, and then within 3 seconds pressing (or in the case of some functions repeatedly pressing) the desired command push-button.

Note: Refer to the "How to Operate" Section of this manual for additional information using this Remote Control.

Play and Pause

With a disc loaded, press the PLAY▶ Push-button to start the disc playing. Press the PLAY▶ Push-button a second time to temporarily stop disc playback at any time (Pause). To resume playback press the PLAY▶ Push-button again.

Note: The Play and Pause functions have been combined into the Play Push-button.

Stop

Press the STOP■ Push-button to stop disc playback and return to displaying the table of contents of the disc.

Numbered Push-buttons

Press 1 through 9 to directly access one of the first nine Disc Tracks using the Front Panel Information Display. For track numbers greater than 10, press the +10 Push-button followed by the 0-9 Push-button. For example, to access Disc Track 23, press the +10 Push-button twice and then the 3 Push-button.

Reverse and Fast Forward

Press the ◀◀ (Reverse) or ▶▶ (Fast Forward) Push-button to start moving rapidly through a track on the disc. When the desired location is reached release the ◀◀ (Reverse) or ▶▶ (Fast Forward) Push-button to resume normal playback.

Back and Next

Press the ▶▶ (Next) Push-button to move forward one track or the ◀◀ (Back) Push-button to move back to the beginning of the current track playing. Also used to review the Programmed Tracks from the disc on the Front Panel Information Display, while in the Program Mode.

Note: If the ◀◀ (Back) Push-button is pressed during playback of the first three seconds of the track, the SACD/CD will start playing back the previous track from the beginning. If the Front Panel Information Display is indicating time, the display will momentarily indicate the track number.

SACD or CD Track Selection

Press the DISC LAYER Push-button to select the SACD or CD Tracks from a hybrid disc for playback.

Display/Time

Press the DISPlay/TIME Push-button to access various disc times. It is also used to return the Front Panel Information Display to indicating time instead of text information on a SACD Disc.

Menu/Text

Press the MENU/TEXT Push-button to select the various text information on a SACD Disc such as Album, Artist and Track Titles (disc dependent).

Repeat Modes

Press the REPEAT Push-button to select either One Track, All Tracks or cancel the Repeat Mode.

Clear

Press the CLEAR Push-button to erase a program track(s).



How to Operate the MCT450

Power On and Off

The LED above the STANDBY/ON Push-button lights to indicate the MCT450 is connected to AC Power. Refer to figure 1. The LED also indicates the status of the Auto Off Feature. When the MCT450 is in the Standby Mode, green illumination indicates the Auto Off Feature is enabled (default setting) and red illumination indicates the Auto Off Feature is disabled. For additional information refer to “Power Mode” on page 20.

STANDBY/ON

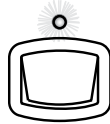



Figure 1

Note: When AC Power is initially applied to the MCT450, the unit will momentarily switch On and then go into the Standby Mode.

To Switch ON the MCT450, momentarily press the STANDBY/ON Push-button on the Front Panel or the  (Power) Push-button on the Remote Control. Refer to figures 2 and 21. The LED above the STANDBY/ON Push-button illuminates green. The Front Panel Display will momentarily indicate “DISC” followed by “READING” and then “NO DISC”. Refer to figures 2, 3, 4, 5 and 21. To switch OFF the MCT450, momentarily press the STANDBY/ON Push-button on the Front Panel or the OFF Push-button on the Remote Control.

DISC READING NO DISC

Figure 3

Figure 4

Figure 5

How to Load and Unload a Disc

1. Press the OPEN/CLOSE Push-button. The disc tray will slide out allowing a CD Disc to be loaded. Refer to figure 6.
2. Press the OPEN/CLOSE Push-button and the disc tray will close. Refer to figure 7. Loading of the CD Disc’s Table of Contents (number of tracks and total playing time) will be indicated on the Front Panel Display. Refer to figure 8.

OPEN

CLOSE

Figure 6

Figure 7

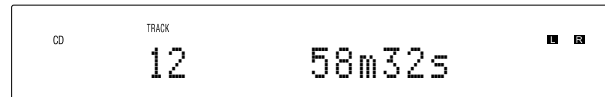

Figure 8

Note: When a Disc is placed in the tray and the PLAY/PAUSE Push-button is pressed, the tray will close and the first track will start playing.

3. Pressing the OPEN/CLOSE Push-button will stop playback of the disc and the disc tray will open.

How to Play a SACD Disc

Load a SACD Disc into the MCT450. The Front Panel Display will first scroll the Album Title of the SACD Disc (available on most SACD Discs). Refer to figures 9, 10 and 11.

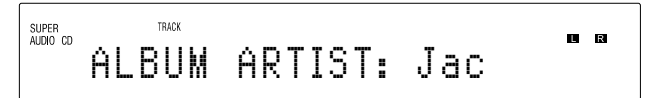

Figure 9

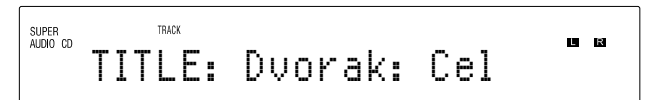

Figure 10

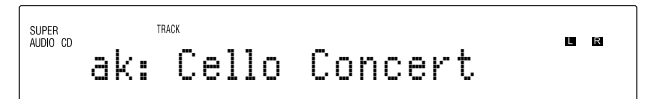

Figure 11

The Album Title is followed by the Table of Contents. Refer to figure 12.

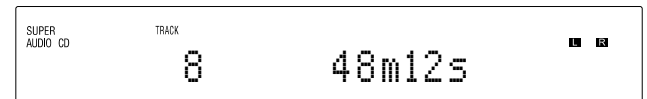



Figure 12

Press the PLAY/PAUSE   Push-button on the Front Panel of the MCT450 or on the Remote Control. Refer to figures 2 and 21. The Disc will start playing the first track of the SACD Layer.

Note: The default setting for SACD/CD Hybrid Disc is to play the SACD Stereo Layer. The default setting may be changed to play the CD Layer or the SACD Multichannel Layer, when available. With the MCT450 On and no disc loaded, press the DISC LAYER Push-button until the Front Panel Display indicates the desired layer.

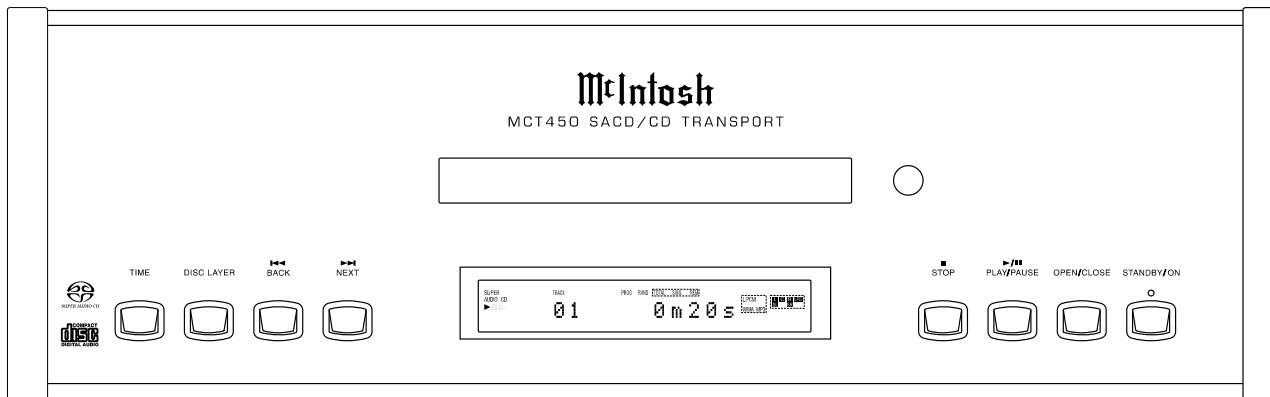

Figure 2

Selection of a different Layer (CD, Stereo or Multichannel) can occur during playback of a disc by pressing the DISC LAYER Push-button once to see the current selection and a second or third time to select the desired Layer. Refer to figures 13, 14 and 15. The Player will stop playing the current Layer and then load the desired Layers' Table of Contents (Number of tracks and Total Playing Time). Once the information is indicated on the front panel display, press the PLAY/PAUSE ►/|| Push-button. Refer to figure 16.

STEREO

Figure 13

MULTI

Figure 14

CD

Figure 15

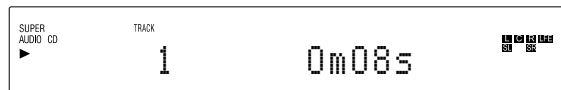

Figure 16

Note: 1. Most SACD Disc(s) have the ability of displaying the Album Title and Artist. With the disc loaded, SACD Table of Contents read and the **disc stopped**, press the MENU/TEXT Push-button once for scrolling the Title and twice for scrolling the Artist Name. Display of the Artist information is not available during playback of the disc. Refer to figures 17, 18 and 21.

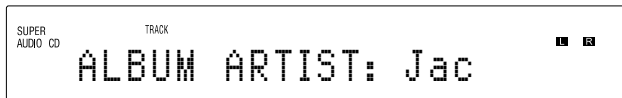

Figure 17

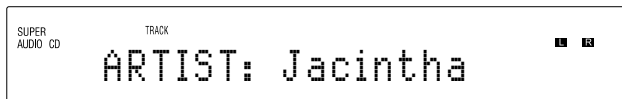

Figure 18

2. In a similar manner, some SACD Discs have the ability of scrolling the Track Number and Title by pressing the MENU/TEXT Push-but-

ton **after** the Track has started to play. Refer to figures 19 and 21.

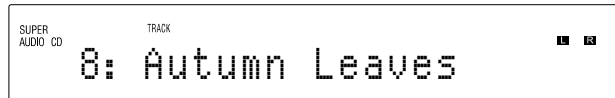

Figure 19

3. The Text Display Mode may be canceled by pressing the DISP/TIME Push-button on the Remote Control. Refer to figure 21.
4. The various Time Modes may be displayed by pressing the DISP/TIME Push-button on the Remote Control. Refer to figure 21. For additional information on the Time Display Modes refer to "Display Modes" on page 20.
5. SACD Discs containing Multichannel sound tracks are down mixed into two channels and available at the Analog Audio Outputs.

How to Play a CD Disc

With a disc already loaded into the MCT450, press the PLAY/PAUSE ►/|| Push-button on the Front Panel of the MCT450 or Remote Control. Refer to figures 2, 20 and 21.

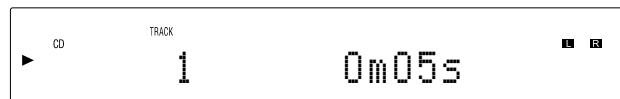

Figure 20

How to Pause a Disc

This feature allows for the temporary stopping of disc playback. Refer to figures 2 and 16.

1. When playing a Disc, press the PLAY/PAUSE ►/|| Push-button to temporarily stop playback.
2. Press the PLAY/PAUSE ►/|| Push-button to resume playing the disc.

Track Back

Return to the beginning of the Track currently playing by rotating the MCT450 Front Panel TRACK BACK ◀◀ Control counterclockwise and then releasing the control or momentarily pressing the ◀◀ Push-button on the Remote Control. Rotate and hold the TRACK BACK ◀◀ Control or press and hold the ◀◀ Push-button on the Remote Control for rapid selection of the desired previous Tracks. Refer to figures 2 and 21.

Track Next

Advance to the next Track by rotating the MCT450 Front Panel TRACK NEXT ▶▶ Control clockwise and then releasing the control or momentarily pressing the ▶▶ Push-button on the Remote Control. Rotate and hold the TRACK NEXT ▶▶ Control or press and hold the ▶▶ Push-button on the Remote Control for rapid selection of the next desired Track. Refer to figures 2 and 21.

Fast Forward or Reverse

Using the Remote Control, press the ▶▶ (Fast Forward) or ◀◀ (Reverse) Push-button to search back and forth rapidly through a Track on a disc. To return to normal playback release the same ▶▶ (Fast Forward) or ◀◀ (Reverse) Push-button. Refer to figure 21.

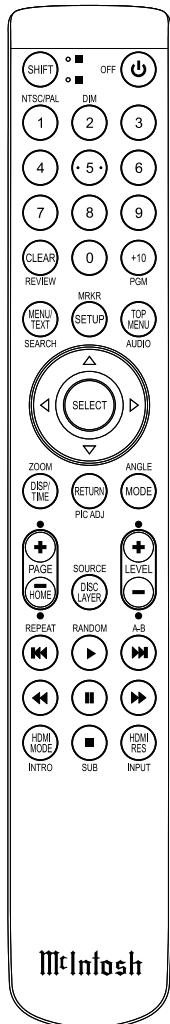

Figure 21



How to Operate the MCT450, con't

Stop Mode

Press the STOP ■ Push-button at any time to stop Playback. To listen to the disc again, press the PLAY/PAUSE ►/|| Push-button and playback will start from the beginning of the disc.

Direct Track Selection

The MCT450 Front Panel Display indicates the Disc Track currently playing. Use the Remote Control NUMERIC Push-button(s) to enter the desired Track Number. Refer to pages 14 and 15 for additional information using the Remote Control.

Repeat

This allows repeating a Track, Disc, Program Mode or Random Play Mode on a continuous basis. Refer to figures 2 and 24.

1. With the disc playing (Regular, Program or Random Playback Modes), press the SHIFT Push-button then the REPEAT Push-button once to activate the Track Repeat (C1); press the REPEAT Push-button twice to activate the Disc Repeat (C). Refer to figures 22 and 23.

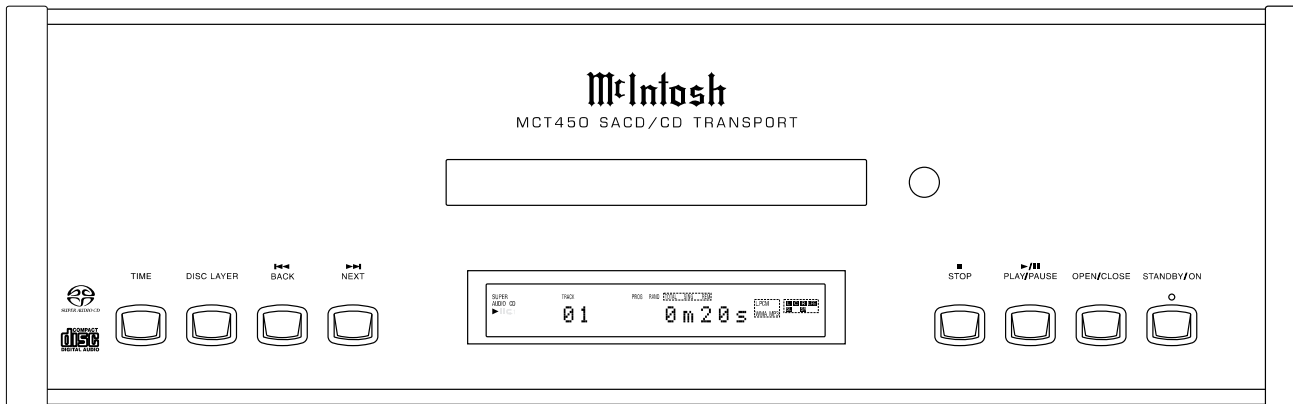

Figure 2



Figure 22



Figure 23

2. To cancel the previously selected Repeat Mode, press the REPEAT Push-button until the character "1" and/or the symbol "C" in the Front Panel Information Display is extinguished.

Random Playback

This feature allows for listening to Tracks of a Disc in a Random Order. Refer to figure 24.

Note: Before the Random Playback Mode feature on the MCT450 can be activated, the disc must be stopped or the message "Press ■ (stop) first" will momentarily appear on the Front Panel Display. Refer to figure 25.

1. With the MCT450 in the STOP ■ Mode press the SHIFT Push-button and then the RANDOM

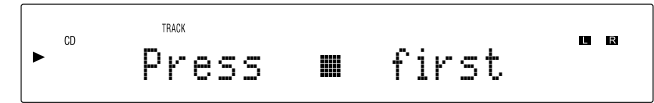

Figure 25

Push-button. The word RANDOM will be indicated in the Front Panel Display. Refer to figure 26.

2. Press the PLAY/PAUSE ►/|| Push-button to start Random Playback. After all the tracks have been played the MCT450 will stop.

Notes: 1. To provide continuous playback of the disc, press the REPEAT Push-button twice to activate the Disc Repeat (C) after the Random Playback Mode has started. If Repeat (C1) is selected, the current track will repeat.

2. The NEXT TRACK ►► function will advance to the next random selection and start playing.

3. To cancel the Random Playback Mode, press the STOP ■ Push-button, then press the RANDOM Push-button twice.

Program Playback

This feature allows for playback of selected Tracks on a Disc in the desired order. In the following example, a Disc is programmed to play Track 6 followed by Track 4 and then Track 2.

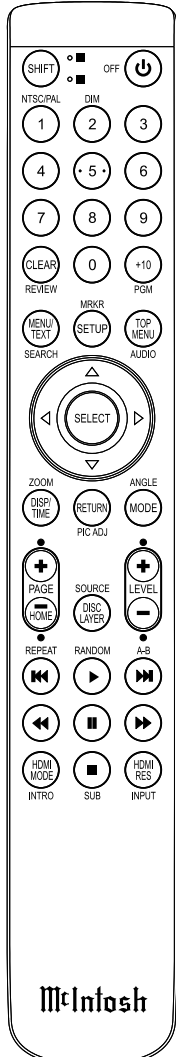

Figure 24



Figure 26

Notes: 1. The MCT450 must be in STOP Mode with the Disc TOC (Table of Contents) read before the Program Playback Mode Feature can be activated.

2. When programming Hybrid SACD Discs, first choose the layer (SACD or CD) so the correct TOC can be read, as some discs have different selections for the SACD and CD Tracks.

1. Press the SHIFT Push-button and then the RANDOM Push-button twice to access the Program Mode. Refer to figures 2, 24 and 27.

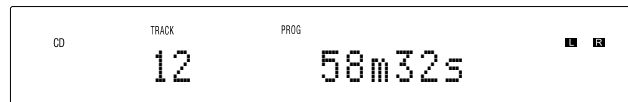

Figure 27

2. Enter the first desired selection (track 6) using the Numeric Push-buttons. The Front Panel Display will first indicate track 6 followed by indicating the total number of tracks and total playback time for the current program. Refer to figures 28 and 29.



Figure 28

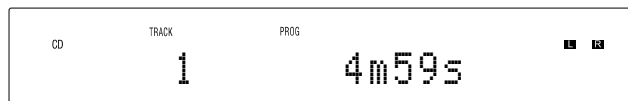

Figure 29

3. In a similar manner, enter the remaining Tracks 4 and 2. Refer to figures 30 thru 33.

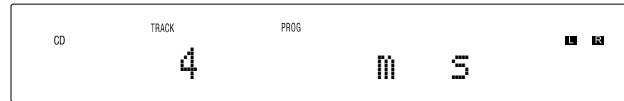

Figure 30

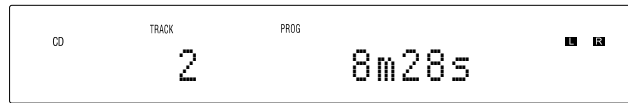

Figure 31



Figure 32

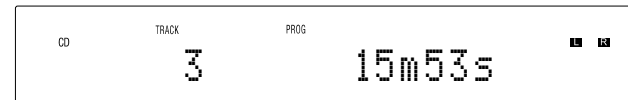

Figure 33

Note: To view and/or delete the selections programmed, use the TRACK NEXT $\blacktriangleright\blacktriangleright$ Push-button to step through programmed tracks and the CLEAR Push-button to remove any unwanted selections.

4. To start playback of the just entered program, press the PLAY/PAUSE $\blacktriangleright/\parallel$ Push-button. Refer to figure 34.

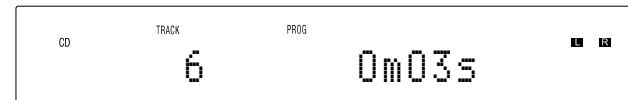

Figure 34

After playback begins, the Repeat Mode can be activated to provide continuous playback of the Programmed Track(s). Refer to figure 24.

Note: To momentarily stop playback, press the PLAY/PAUSE $\blacktriangleright/\parallel$ Push-button. To resume Program Playback press the PLAY/PAUSE $\blacktriangleright/\parallel$ Push-button.

5. To cancel the Program Playback Mode, press the STOP \blacksquare Push-button, then the SHIFT Push-button and then the RANDOM Push-button.

Once the Program Playback Mode is active, tracks may be added or deleted by first pressing the STOP \blacksquare Push-button followed by entering the additional tracks using the Numeric Push-buttons or delete the last track programmed by using the CLEAR Push-button.

MP3/WMA Disc Playback

The MCT450 has the ability of playing back MP3 and WMA encoded discs. MP3 and some version of WMA coding allow more tracks on the Disc by using the technique of lossy compression applied to the original audio information. These Tracks have lower audio quality than the original recording. Load a MP3/WMA disc into the MCT450. Refer to figure 36.



Figure 36

The MCT450 has two MP3/WMA Modes of Operation: Disc Mode and Folder Mode. Refer to figures 37 and 38. Select the desired mode by pressing the

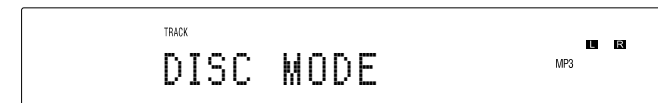

Figure 37

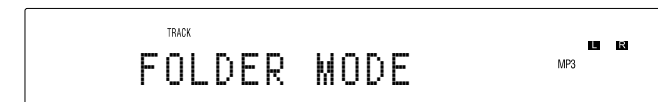

Figure 38

MODE Push-button on the Remote Control. The Disc Mode will play back all the tracks on the disc starting with tracks not in folders first, followed



How to Operate the MCT450, con't

by the track contained in the folder second. The Folder Mode will play back the tracks contained in the selected folder. Refer to figure 39.



Figure 39

1. Press the PLAY/PAUSE ►/|| Push-button to start Playback. Refer to figure 40.



Figure 40

After all the tracks have been played the MCT450 will stop.

Note: Use the ▲ up and ▼ down directional Push-buttons to select folders on the disc.

Display Modes

The MCT450 Front Panel Display indicates both track number and playing time. There are three playing time display indications: track elapse time, track remaining time or disc remaining time. To change from the de-

fault setting of track elapse time, press the DSP/TIME Push-button on the Remote Control. Refer to figures 24, 41, 42 and 43.



Figure 41

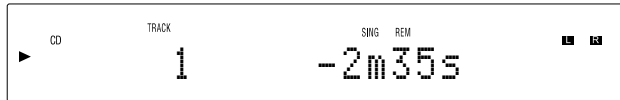

Figure 42



Figure 43

Display Brightness

There are four available Settings for the Front Panel Display. The choices include three brightness settings, high (default setting), medium or low and the display may be switched Off. To change the brightness setting perform the following steps and refer to figure 24:

1. Press the SHIFT Push-button.

2. Momentarily press the 2 (DIM) Push Button to change the current brightness setting. Repeat this until the desired brightness setting is selected.
3. Press the DISC LAYER Push-button to store the new brightness setting.

Power Mode

The MCT450 incorporates an Auto Off Feature, which can automatically place the SACD/CD Transport into the Power Saving Standby/Off Mode (default setting). This occurs approximately 30 minutes after there has been an absence of a Digital Audio Signal. If it is desirable to disable the Auto Off Feature, perform the following steps:

1. Using the MCT450 Remote Control, press and hold in the ⏻ (Power) Push-button for about 5-10 seconds, at which time the Front Panel Display indicates "Auto STBY Off". Refer to figure 44.

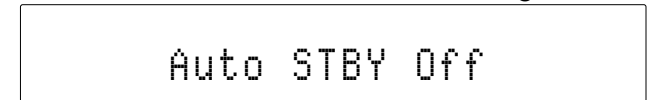

Figure 44

2. The MCT450 will switch Off and the LED above the STAND/BY Push-button will illuminate Red in color. Press the ⏻ (Power) Push-button to switch the MCT450 On.
3. To re-activate the Auto Off Feature, press and hold in the ⏻ Power Push-button on the Remote Control for about 5-10 seconds, at which time the Front Panel Display indicates "Auto STBY On". Refer to figure 45.

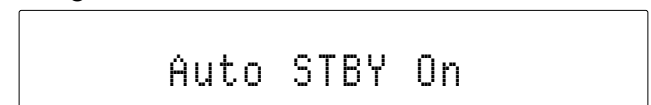

Figure 45

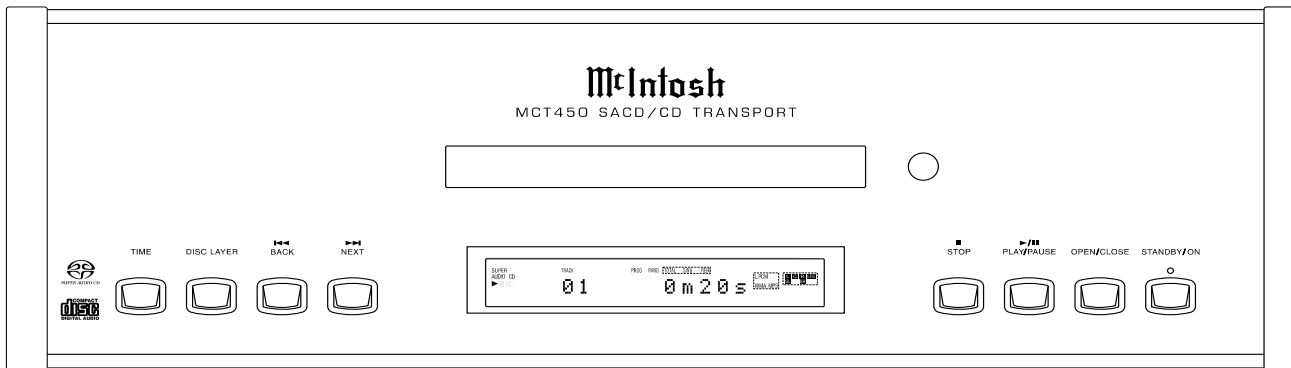



Figure 2

- The MCT450 will switch Off and the LED above the STAND/BY Push-button will illuminate Green in color. Press the  (Power) Push-button to switch the MCT450 On.

Resetting the MCT450

In the unlikely event the MCT450 stops functioning, first try resetting the Main (System) microprocessor by performing the following:



- Simultaneously press and hold in the Front Panel TIME and DISC LAYER Push-buttons until the illumination of the LED above the STAND/BY Push-button goes Off. The MCT450 will then switch Off.
- Press the STAND/BY Push-button to switch the MCT450 back On.



Note: Resetting of the microprocessor also places the Power Saving Mode into the default setting of On.

If the MCT450 is still not functioning properly, reset the Secondary (Transport) microprocessor by performing the following:

- Switch Off A.C. Power going to the MCT450.

Note: Temporarily, connect the AC Power Cord coming from the MCT450 into an AC Power Strip with an On/Off Switch. Position the AC Power Strip so the On/Off Switch on the strip is in very close proximity to the MCT450 Front Panel NEXT and STOP Push-buttons (the MCT450 Remote Control STOP Push-button will not work for resetting the micro).

- Press and hold in the NEXT  and STOP  Push-buttons while at the same time switching On the AC Power Strip.

- The Front Panel will indicate “RESET” and then go through the process of reading the Disc for playback. At this time release the NEXT  and the STOP  Push-button.
- The MCT450 will resume normal operation.

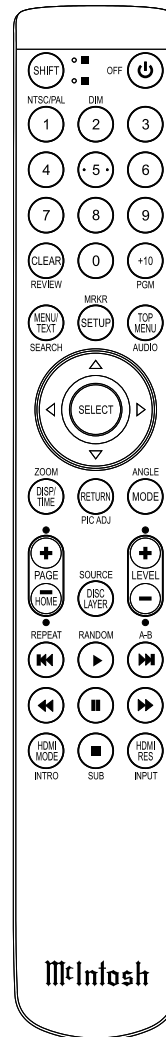
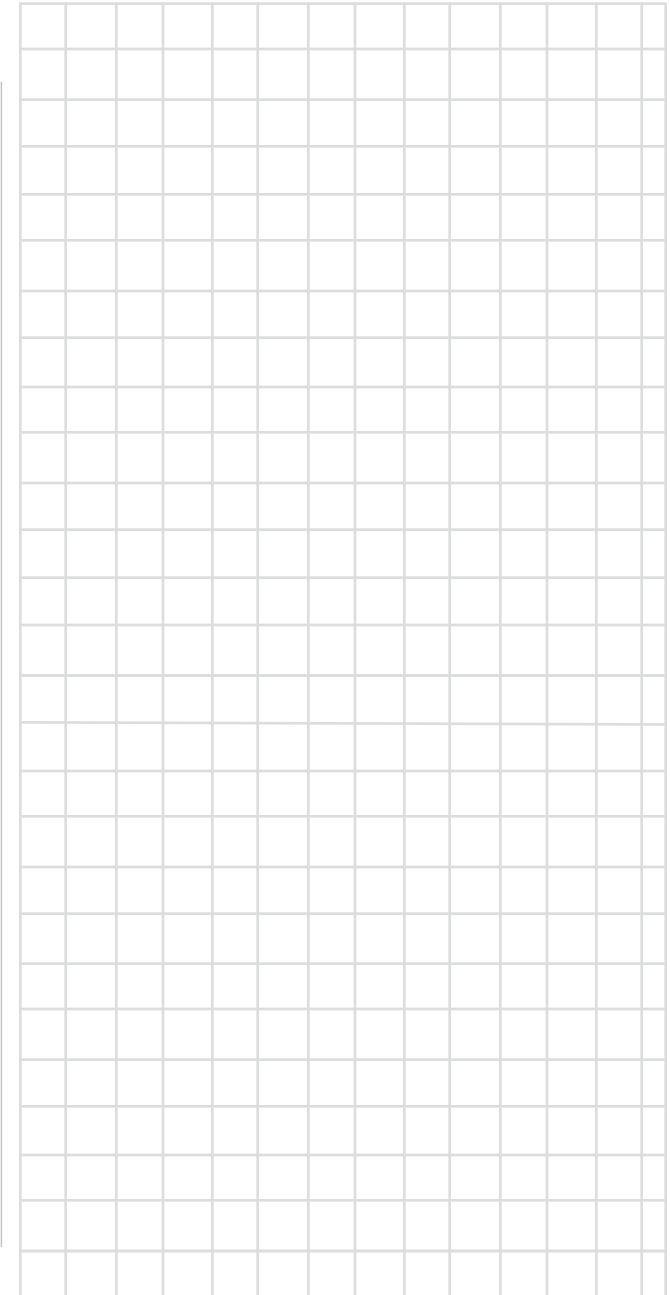

Figure 24





Digital Audio Specifications

Digital Audio Output Format

Coaxial, Optical and XLR: SPDIF (PCM¹), IEC958
Digital DIN: SPDIF (PCM¹), IEC958 and DSD
(SACD)

Digital Audio Outputs

Coaxial: 0.5V p-p/75 ohms
Optical: - 15dbm to -21dbm (TOS Link)
XLR: 0.5V p-p/150 ohms
Digital DIN: 3V @110 ohms

Digital Audio Output Sample Rates

Coaxial: Up to 24-Bit/96kHz
Optical: Up to 24-Bit/192kHz
XLR: Up to 24-Bit/192kHz, Up to 32-Bit/96kHz

¹PCM (Pulse Code Modulation) Digital Signal type used for CD Discs

²DSD (Direct Stream Digital) Digital Signal type used for SACD Discs

General Specifications

Transport

Laser Type: Twin Beam
Laser Beam Wavelength: 650nm (SACD)/790nm (CD)
Laser Power: CLASS IIa/CLASS I

Power Requirements

100 Volts, 50/60Hz at 35 watts
110 Volts, 50/60Hz at 35 watts
120 Volts, 50/60Hz at 35 watts
220 Volts, 50/60Hz at 35 watts
230 Volts, 50/60Hz at 35 watts
240 Volts, 50/60Hz at 35 watts
Standby: Less than 0.5 watt

Note: Refer to the rear panel of the MCT450 for the correct voltage.

Overall Dimensions

Width is 17-1/2 inches (44.4cm)
Height is 6 inches (15.2cm)
Depth is 19 inches (48.3cm) including the Front Panel and Cables

Note: When the Disc Tray is opened, the panel clearance required in front of mounting panel is 6-3/4 inches (17.2cm).

Weight

26 pounds (11.8Kg) net, 40.5 pounds (18.4Kg) in shipping carton

Shipping Carton Dimensions

Width is 26-1/2 inches (67.3cm)
Depth is 24-1/4 inches (62.2cm)
Height is 11-3/4 inches (29.9cm)

Packing Instructions

In the event it is necessary to repack the equipment for shipment, the equipment must be packed exactly as shown below. It is very important that the four plastic feet are attached to the bottom of the equipment. This will ensure the proper equipment location on the bottom pad. Failure to do this will result in shipping damage.

Use the original shipping carton and interior parts only if they are all in good serviceable condition. If a shipping carton or any of the interior part(s) are needed, please call or write Customer Service Department of McIntosh Laboratory. Refer to page 4. Please see the Part List for the correct part numbers.

Quantity	Part Number	Description
1	033838	Shipping carton only
4	033837	End cap
1	033836	Inside carton only
1	033725	Top pad
1	034301	Bottom pad
2	034446	Foam plug
4	017937	Plastic foot
4	400159	#10-32 x 3/4" screw
4	404080	#10 Flat washer

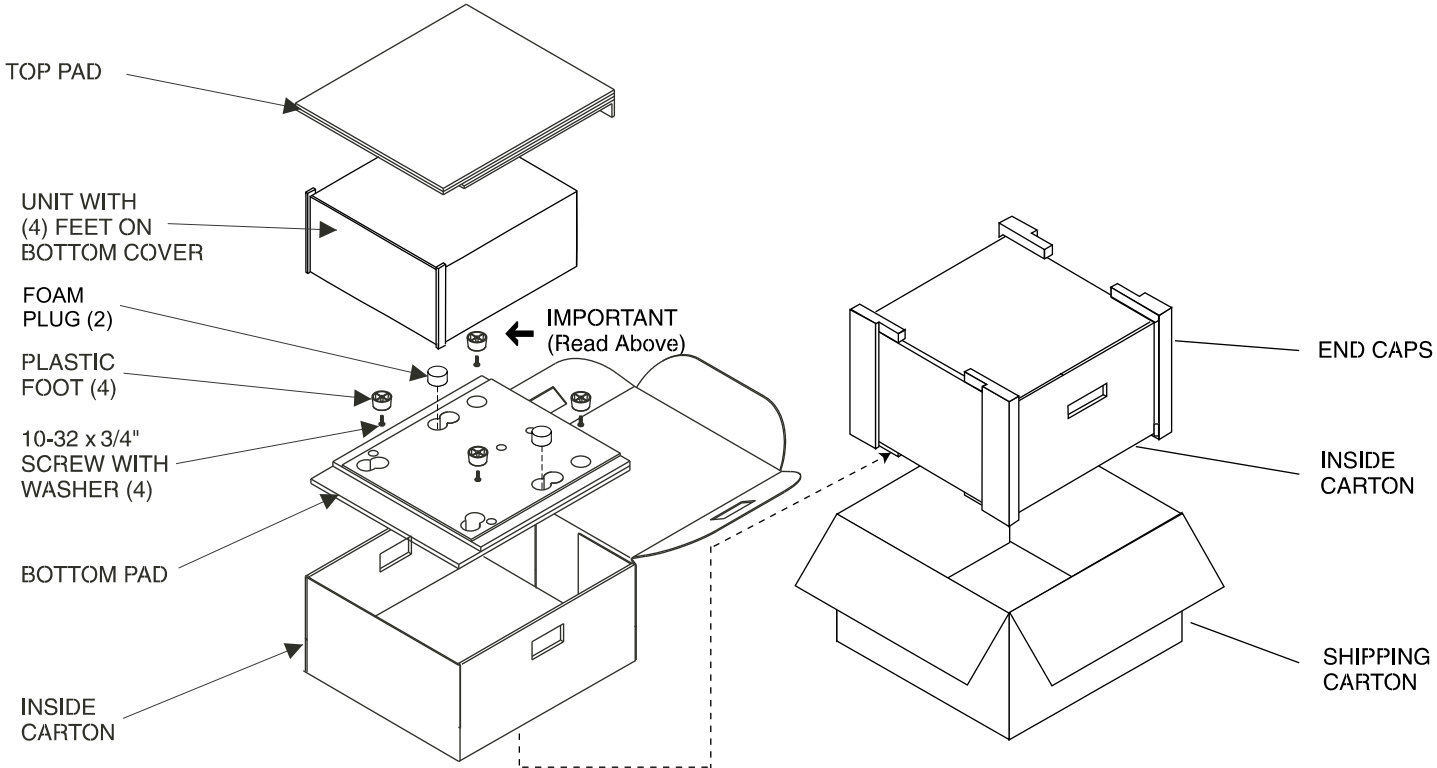



McIntosh Laboratory, Inc.
2 Chambers Street
Binghamton, NY 13903
www.mcintoshlabs.com

The continuous improvement of its products is the policy of McIntosh Laboratory Incorporated who reserve the right to improve design without notice.
Printed in the U.S.A.