



McIntosh Laboratory, Inc. 2 Chambers Street Binghamton, New York 13903-2699 Phone: 607-723-3512 www.mcintoshlabs.com

MCT80
SACD/CD Transport
Owner's Manual





The lightning flash with arrowhead, within an equilateral triangle, is intended to alert the user to the presence of uninsulated “dangerous voltage” within the product’s enclosure that may be of sufficient magnitude to constitute a risk of electric shock to persons.

WARNING - TO REDUCE RISK OF FIRE OR ELECTRICAL SHOCK, DO NOT EXPOSE THIS EQUIPMENT TO RAIN OR MOISTURE.

Additional Safety Information is supplied in a separate document “Important Additional Operation Information Guide”



ATTENTION:
RISQUE DE CHOC ELECTRIQUE - NE PAS OUVRIR

NO USER-SERVICEABLE PARTS INSIDE. REFER SERVICING TO QUALIFIED PERSONNEL.

The exclamation point within an equilateral triangle is intended to alert the user to the presence of important operating and maintenance (servicing) instructions in the literature accompanying the appliance.

To prevent the risk of electric shock, do not remove cover or back. No user-serviceable parts inside.

CAUTION: Invisible Laser Radiation when open. DO NOT stare into the beam or view directly with optical instruments. Use of controls or adjustments or performance of procedures other than those specified in the Owners Manual may result in Hazardous Radiation Exposure.

ATTENTION: Rayonnement Laser Invisible en cas d’ouverture. Ne pas regarder dans le faisceau ni observer directement à l’aide d’instruments d’optiques. L’utilisation de commandes, de réglages ou d’instructions autres que ceux spécifiés dans le manuel du propriétaire peut entraîner une exposition x à des rayonnements dangereux

This product incorporates an embedded CLASS 3R Laser (IEC60825-1).

**LUOKAN 1 LASERLAITE
KLASS 1 LASER APPARAT**

VAROITUS! Laitteen käyttäminen muulla kuin tassa kayttoohjeessa mainitulla tavalla saattaa altistaa kayttajan turvallisuusluokan 1 ylittavalle nakymattomalle lasersateiille.

VARNING! Om apparaten anvands pa annat satt an denna bruksanvisning specificerats, kan anvandaren utsattas for osynbg laserstraining, som overskrider gransen for laserklass 1.

CAUTION: CLASS 3R INVISIBLE LASER RADIATION WHEN OPEN. DO NOT STARE INTO THE BEAM OR VIEW DIRECTLY WITH OPTICAL INSTRUMENTS. AVOID DIRECT EYE EXPOSURE.
ATTENTION: RAYONNEMENT LASER INVISIBLE DE CLASSE 3R EN CAS D’OUVERTURE. NE PAS REGARDER DANS LE FAISCEAU NI OBSERVER DIRECTEMENT A L’AIDE D’INSTRUMENTS D’OPTIQUE. EXPOSITION DIRECTE DANGEREUSE DES YEUX.

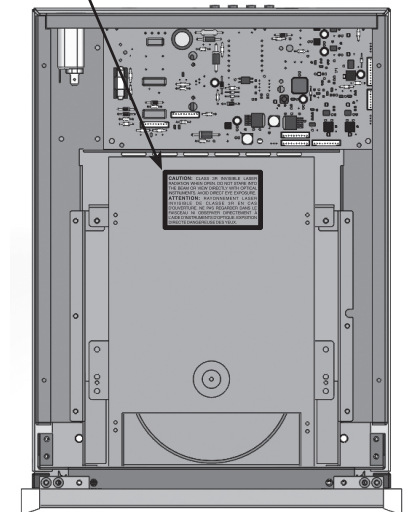
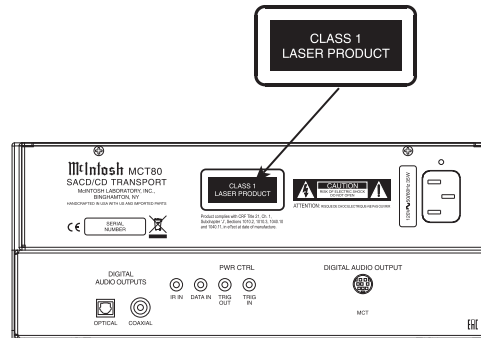

Thank You

Your decision to own this McIntosh MCT80 SACD/CD Transport ranks you at the very top among discriminating music listeners. You now have “The Best.” The McIntosh dedication to “Quality,” is assurance that you will receive many years of visual and musical enjoyment from this unit.

Please take a short time to read the information in this manual. We want you to be as familiar as possible with all the features and functions of your new McIntosh.

Please Take A Moment

The serial number, purchase date and McIntosh Dealer name are important to you for possible insurance claim or future service. The spaces below have been provided for you to record that information:

Serial Number: _____

Purchase Date: _____

Dealer Name: _____

Technical Assistance

If at any time you have questions about your McIntosh product, contact your McIntosh Dealer who is familiar with your McIntosh equipment and any other brands that may be part of your system. If you or your Dealer wish additional help concerning a suspected problem, you can receive technical assistance for all McIntosh products at:

McIntosh Laboratory, Inc.
2 Chambers Street
Binghamton, New York 13903
Phone: 607-723-1545
Fax: 607-724-0549

Customer Service

If it is determined that your McIntosh product is in need of repair, you can return it to your Dealer. You can also return it to the McIntosh Laboratory Service Department. For assistance on factory repair return procedure, contact the McIntosh Service Department at:

McIntosh Laboratory, Inc.
2 Chambers Street
Binghamton, New York 13903
Phone: 607-723-3515
Fax: 607-723-1917

Table of Contents

Safety Instructions	2
(Separate Sheet)	Important Additional
	Operation Information Guide
Thank You and Please Take a Moment.....	3
Technical Assistance and Customer Service	3
Table of Contents	3
General Information	4
Connector and Cable Information	4
Disc Information.....	4-5
Introduction.....	5
Performance Features	5
Dimensions	6
Installation	7
Connections:	
Rear Panel Connectors.....	8
Making Connections.....	10-11
Front Panel Features:	
Front Panel Display and Push-buttons.....	12
Front Panel Information Display.....	13

Remote Control:

Remote Control Push-buttons for CD Disc and SACD Disc Playback	14
How to Use the Remote Control for CD Disc and SACD Disc Playback	15
Remote Control Push-buttons for Playback of Data CD and Data DVD Disc.....	16
How to Use the Remote Control for Playback of Data CD and Data DVD Disc.....	17

Operation:

How to Operate the MCT80	18-24
--------------------------------	-------

Additional Information:

Photos.....	25
Specifications.....	26
Packing Instruction.....	27



General Information

1. For additional connection information, refer to the owner's manual(s) for any component(s) connected to the MCT80 SACD/CD Transport.
2. The Super Audio Compact Discs Audio Signals are available at the Digital Audio Output MCT Connector. Compact Discs Audio Signals are available at the Digital Audio Output XRL, Optical, Coaxial and MCT Connectors.
3. The IR Input, with a 3.5mm mini phone jack, is configured for non-McIntosh IR sensors such as a Xantech Model HL85BK Kit. Use a Connection Block such as a Xantech Model ZC21 when two or more IR sensors need to be connected to the MCT80.
5. When discarding the unit, comply with local rules or regulations. Batteries should never be thrown away or incinerated but disposed of in accordance with the local regulations concerning battery disposal.
6. For additional information on the MCT80 and other McIntosh Products please visit the McIntosh Web Site at www.mcintoshlabs.com.



Connector and Cable Information

Data and IR Input Port Connectors

The MCT80 Data In Port receives Remote Control Signals. A 1/8 inch stereo mini phone plug is used for connection. The IR Ports also use a 3.5mm stereo mini phone plug and allow the connection of other brand IR Receivers to the MCT80.

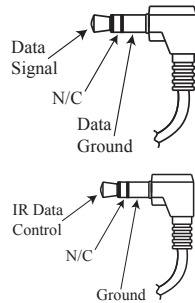

Power Control Connector

The MCT80 Power Control Input receives an On/Off signal from +5 to +12 volts. The Power Control Output will then send out a +12 volt Output Signal with a total current up to 50mA. An additional connection is for controlling the illumination of the Power Output Meters. The 3.5mm stereo mini phone plug connects to a McIntosh Preamplifier or A/V Control Center Power Control Output.

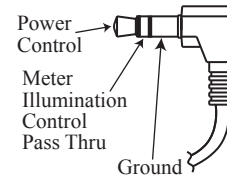

Digital MCT Cable

The Digital MCT Cable supplied with the MCT80 is a McIntosh Designed Custom Cable. A substitute cable will not work with the MCT80 and McIntosh Integrated Amplifier or Preamplifier with a Digital MCT Connector. If it should become necessary to replace the supplied Digital MCT cable, order part number 171923 from the McIntosh Parts Department.



Disc Information

1. The MCT80 is designed to play round Compact Discs; do not try other shapes or possible damage may occur.
2. The MCT80 SACD/CD Transport is designed to play all industry standard "Redbook" CD Audio Discs as indicated by the  Symbol. It will also play most CD-R, CD-RW and Dual Discs, however some recorded discs may not be able to play due to the condition of the recording or manufacturing.
3. Disc with tracks recorded with MP3 and WMA Formats will playback on the MCT80 when the writing software used to create them conforms to the ISO9660 Level 1 standard.
4. The PCM (Pulse Code Modulation) Digital Signal, is the standard for Audio CD Discs and is available at all Digital Audio Output Connectors on the MCT80. Discs with WAV and MP3 file formats are converted internally to a PCM Digital Signal.
5. Several of the SACD performance features available on the MCT80 are active only if the SACD Disc includes the supporting encoded information.
6. Playing back Audio from a CD Disc and a SACD Disc (CD Layer) is available at the MCT, Optical and Coaxial Digital Outputs. When a SACD Disc is playing back a 2 Channel Layer, the Digital Audio is only available at the MCT Digital Audio Output, with the Optical and Coaxial Outputs muted. (The Multichannel Layer will be silent because the MCT80 is a stereo unit.)
7. The MCT80 has the ability to playback a user created DVD Data Disc. When a disc has Audio Tracks up to DSD128 and PCM up to 96Khz/24Bit, the Digital Audio Signal is available at the MCT Digital Audio Output. PCM Audio Tracks up to 192kHz-24Bit are available at the Optical and Coaxial Digital Outputs.

Introduction

The McIntosh MCT80 SACD/CD Transport offers the latest in audio technology, providing state of the art reproduction of audio discs. A full complement of performance features allows for the enjoyment of the SACD and CD Disc Audio Formats. The advanced mechanical design of the transport ensures many years of smooth trouble free operation.

Performance Features

• **Twin Laser Pickup**

The MCT80 incorporates two laser elements, with different wavelengths, that are focused through one lens assembly. This unique design allows reading both the CD and Super Audio Compact Disc (SACD) Discs Formats.

• **Advanced Transport**

The MCT80 has a new transport with a Die Cast Tray. It has the latest in advanced digital servo for faster, quieter and accurate operation. The Disc Audio Data is read at twice the normal rate insuring better disc tracking and error correction processing.

• **Advanced Digital MCT Output**

A unique Digital MCT Output connects to McIntosh Integrated Amplifier or Preamplifier with a Digital MCT Connector for the purist possible sound quality.

• **Digital Audio Outputs**

The MCT80 Digital Outputs include MCT, Coaxial, and Optical Connections.

• **Power Control and Full Function Remote Control**

The Power Control Input Connection switches the MCT80 On/Off with other McIntosh Components in a system. The Remote Control with illuminated

push-buttons provides complete control of the MCT80 operating functions.

• **Multi-Function Front Panel Display**

The MCT80 Front Panel display indicates the current disc playback status.

• **Special Power Supply**

The Digital Power Supply and Multiple Regulators ensure stable noise free operation even though the power line varies.

• **Glass Front Panel and Super Mirror Chassis**

The MCT80 has the famous McIntosh Illuminated Glass Front Panel and Stainless Steel Super Mirror Finish Chassis. These highly durable materials will ensure the pristine beauty of the MCT80 will be retained for many years.

• **Fiber Optic Solid State Front Panel Illumination**

The Illumination of the Front Panel is accomplished by the combination of custom designed Fiber Optic Light Diffusers and extra long life Light Emitting Diodes (LEDs). This provides even Front Panel Illumination and is designed to ensure the pristine beauty of the MCT80 will be retained for many years.

Media and Format Type of Music Playback			
Media Type	Format Type and File Extension	Maximum Sampling Frequency	Maximum Bit Rate
CD Disc (R/-RW)	MP3 (.mp3)	48KHz	Up to 320kbs
CD Disc (R/-RW)	WMA (.wma)	48KHz	Up to 320kbs
CD Disc (R/-RW)	ACC (.mp4)	48KHz	Up to 320kbs
CD Disc (R/-RW+R+RW)	WAV (.wma)	48KHz	16Bit
CD Disc (R/-RW+R+RW)	FLAC (.flac)	48KHz	16Bit
CD Disc (R/-RW+R+RW)	ALAC (.m4a)	48KHz	16Bit
CD Disc (R/-RW+R+RW)	AIFF(.aif/aiff)	48KHz	16Bit
DVD Disc (R/-RW+R+RW)	WAV (.wma)	192KHz	Up to 24Bit
DVD Disc (R/-RW+R+RW)	FLAC (.flac)	192KHz	Up to 24Bit
DVD Disc (R/-RW+R+RW)	ALAC (.m4a)	192KHz	Up to 24Bit
DVD Disc (R/-RW+R+RW)	AIFF(.aif/aiff)	192KHz	Up to 24Bit
DSD Disc (DSD64 to DSD128)	DSD(.diff/dsf)	5.6MHz	1Bit



Dimensions

The following dimensions can assist in determining the best location for your MCT80.

Front View of the MCT80

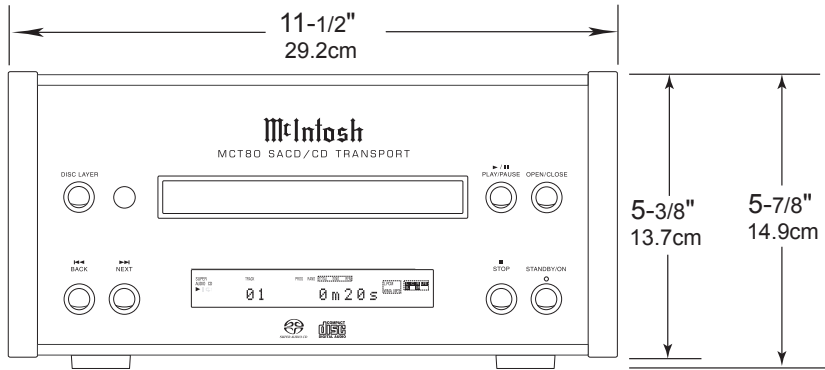

Rear View of the MCT80

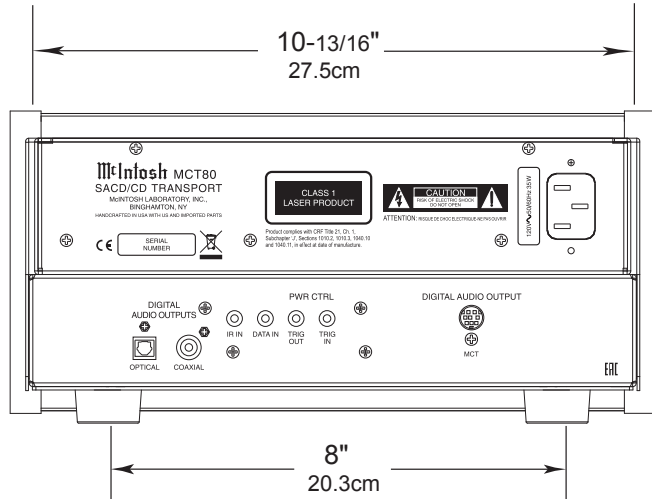

Side View of the MCT80

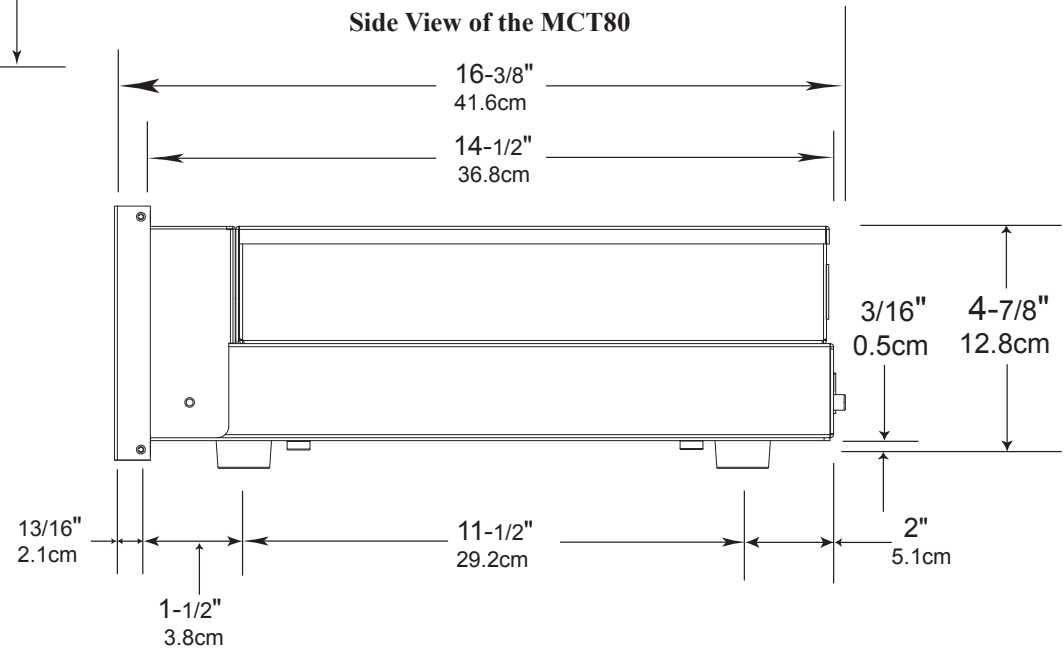

Installation

The MCT80 can be placed upright on a table or shelf, standing on its four feet. It also can be custom installed in a piece of furniture or cabinet of your choice. The four feet may be removed from the bottom of the MCT80 when it is custom installed as outlined below. The four feet together with the mounting screws should be retained for possible future use if the MCT80 is removed from the custom installation and used free standing. The required panel cutout, ventilation cutout and unit dimensions are shown.

Always provide adequate ventilation for your MCT80. Cool operation ensures the longest possible operating life for any electronic instrument. Do not install the MCT80 directly above a heat generating component such as a high powered amplifier. If all the components are installed in a single cabinet, a quiet running ventilation fan can be a definite asset in maintaining all the system components at the coolest possible operating temperature.

A custom cabinet installation should provide the following minimum spacing dimensions for cool operation.

Allow at least 2 inches (5.1cm) above the top, 2 inches (5.1cm) below the bottom and 1 inch (2.5cm) on each side of the SACD/CD Transport, so that airflow is not obstructed. Allow 17 inches (43.2cm) depth behind the front panel. Allow 1-1/8 inch (2.9cm) in front of the mounting panel for knob clearance. Be sure to cut out a ventilation hole in the mounting shelf according to the dimensions in the drawing.

**MCT80 Front Panel
Custom Cabinet Cutout**

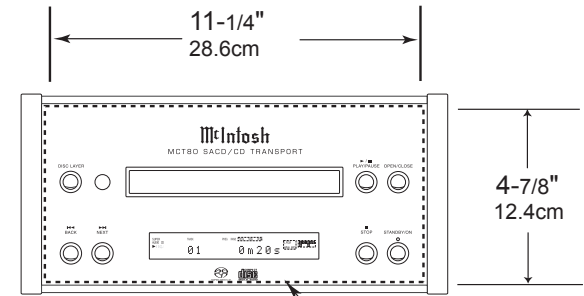

Cutout Opening for Custom Mounting

**MCT80 Side View
in Custom Cabinet**

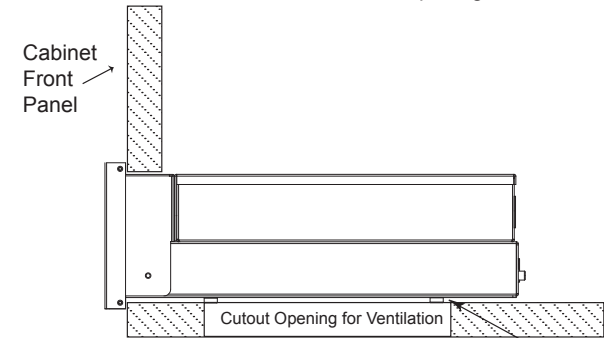

**MCT80 Bottom View
in Custom Cabinet**

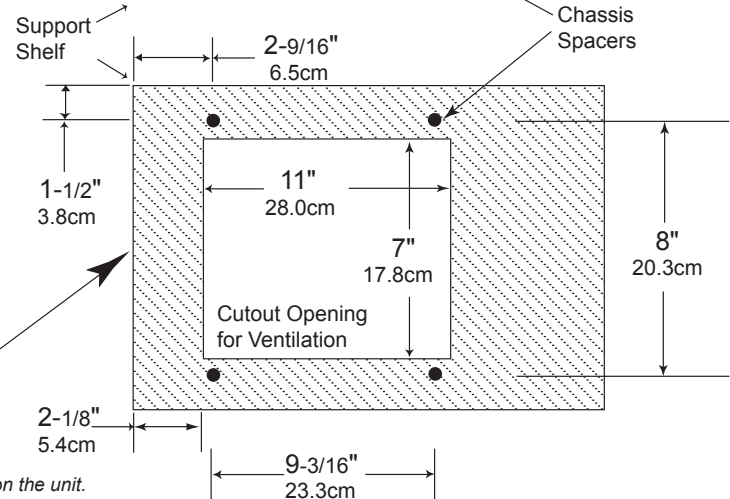

Note: Center the cutout Horizontally on the unit.
For purposes of clarity, the above illustration is not drawn to scale.

IR IN for connecting an IR Receiver

DATA IN receives control data from a McIntosh Integrated Amplifier or Preamplifier

Connect the MCT80 power cord to a live AC outlet. Refer to information on the back panel of your MCT80 to determine the correct voltage for your unit

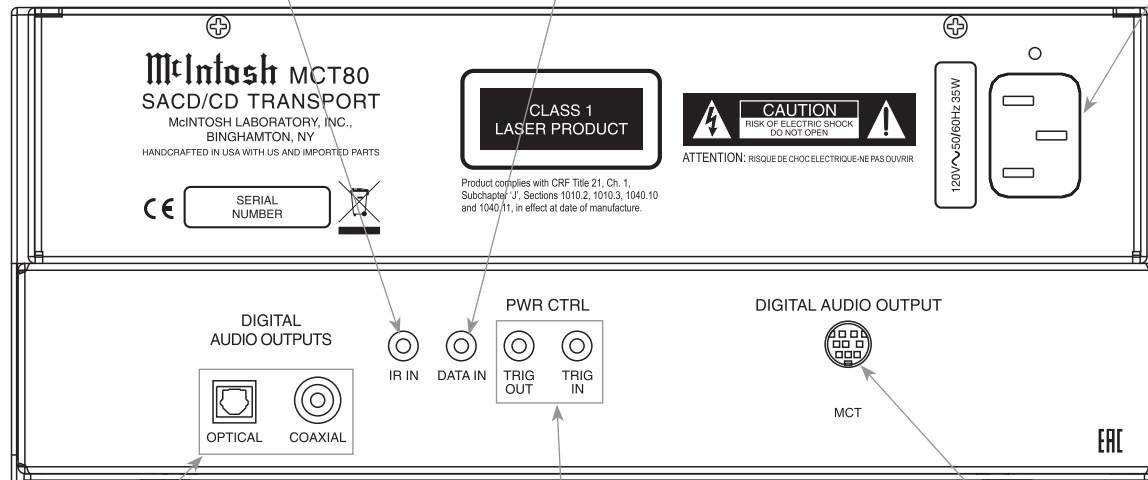

PWR CTRL (Power Control) TRIGGER IN receives turn-on signals from a McIntosh component and PWR CTRL TRIGGER OUT sends turn-on signals on to another McIntosh Component

OPTICAL and COAXIAL DIGITAL AUDIO OUTPUTS send a PCM Digital Audio Signal to a Preamplifier or an A/V Control Center to decode the signal into analog audio

DIGITAL AUDIO OUTPUT MCT sends a PCM or SACD Digital Signal to a Preamplifier with internal D/A Converter to decode the signal into analog audio



Connections using Digital MCT Output

The MCT80 Digital Audio MCT Output Connector outputs PCM and SACD Digital Disc Signals when connected to a compatible McIntosh Integrated Amplifier or Preamplifier. Power Control provides the ability to be remotely switched On/Off from an Integrated Amplifier or Preamplifier via the PWR CTRL (Power Control) Connection.

The MCT80 Data Port Connection allows for the remote operation of basic functions using the Integrated Amplifier or Preamplifier Remote Control. With an external sensor connected to the MCT80, remote control operation is possible from another room and/or when the MCT80 is located in a cabinet with the doors closed.

The connection instructions below, together with the MCT80 Connection Diagram on the opposite page is an example of a typical audio system. Your system may vary from this, however the actual components would be connected in a similar manner. For additional information refer to “Connector and Cable Information” on page 4.

Power Control Connections:

1. Connect a Control Cable from the Integrated Amplifier or Preamplifier Power Control Out Jack to the PWR CTRL (Power Control) TRIGGER IN Jack on the McIntosh MCT80 SACD/CD Transport.
2. Optionally, connect a Control Cable from the MCT80 SACD/CD Transport PWR CTRL (Power Control) TRIGGER OUT Jack to additional McIntosh components with a Power Control In Jack.

Data Control Connections:

3. When a connection on the Integrated Amplifier or Preamplifier is available, connect a Control Cable from the Preamplifier CD Data Port Jack to the McIntosh MCT80 SACD/CD Transport DATA IN Jack.

Sensor Connections:

4. Optionally, connect an IR Sensor to the McIntosh MCT80 SACD/CD Transport IR IN Jack.

Digital Audio Connections:

5. Connect the supplied Digital MCT Cable from the McIntosh MCT80 SACD/CD Transport DIGITAL AUDIO OUTPUT MCT connector to the Digital MCT Input Connector on the Integrated Amplifier or Preamplifier.

AC Power Cords Connections:

6. Connect the McIntosh MCT80 SACD/CD Transport AC Power Cord to a live AC outlet.

Connections using Digital Coaxial or Optical Output

The MCT80 may be connected to an Integrated Amplifier or Preamplifier via the Coaxial or Optical Output Connections for playback of discs with PCM Digital Signals.

- Notes:*
1. For playback of SACD Discs, the Digital MCT Output Connection between the MCT80 and Digital MCT Audio Input on an Integrated Amplifier or Preamplifier is required.
 2. When playing back high resolution DVD Data or CD Data Disc PCM recording with a sampling rate higher than 92kHz/24Bit, the Optical or Coaxial connection between the MCT80 and Integrated Amplifier or Preamplifier will be required for listening.

The following connection instructions, together with the MCT80 Connection Diagram on the opposite page, is an example of a typical audio system. Your system may vary from this, however the actual components would be connected in a similar manner. For additional information refer to “Connector and Cable Information” on page 4.

Power Control Connections:

1. Connect a Control Cable from the Integrated Amplifier or Preamplifier Power Control Out Jack to the PWR CTRL (Power Control) TRIGGER IN Jack on the McIntosh MCT80 SACD/CD Transport.
2. Optionally, connect a Control Cable from the MCT80 SACD/CD Transport PWR CTRL (Power Control) TRIGGER OUT Jack to additional McIntosh components with a Power Control In Jack.

Data Control Connections:

3. When a connection on the Integrated Amplifier or Preamplifier is available, connect a Control Cable from the Integrated Amplifier or Preamplifier CD Data Port Jack to the McIntosh MCT80 SACD/CD Transport DATA IN Jack.

Digital Audio Connections:

4. Connect a fiber Optical Cable from the MCT80 SACD/CD Transport DIGITAL AUDIO OUTPUT OPTICAL Connector to the Optical Digital Input on the Integrated Amplifier or Preamplifier.

Note: A Coaxial Cable Connection may be used instead of the Optical Connection.

AC Power Cords Connections:

5. Connect the McIntosh MCT80 SACD/CD Transport AC Power Cord to a live AC outlet.

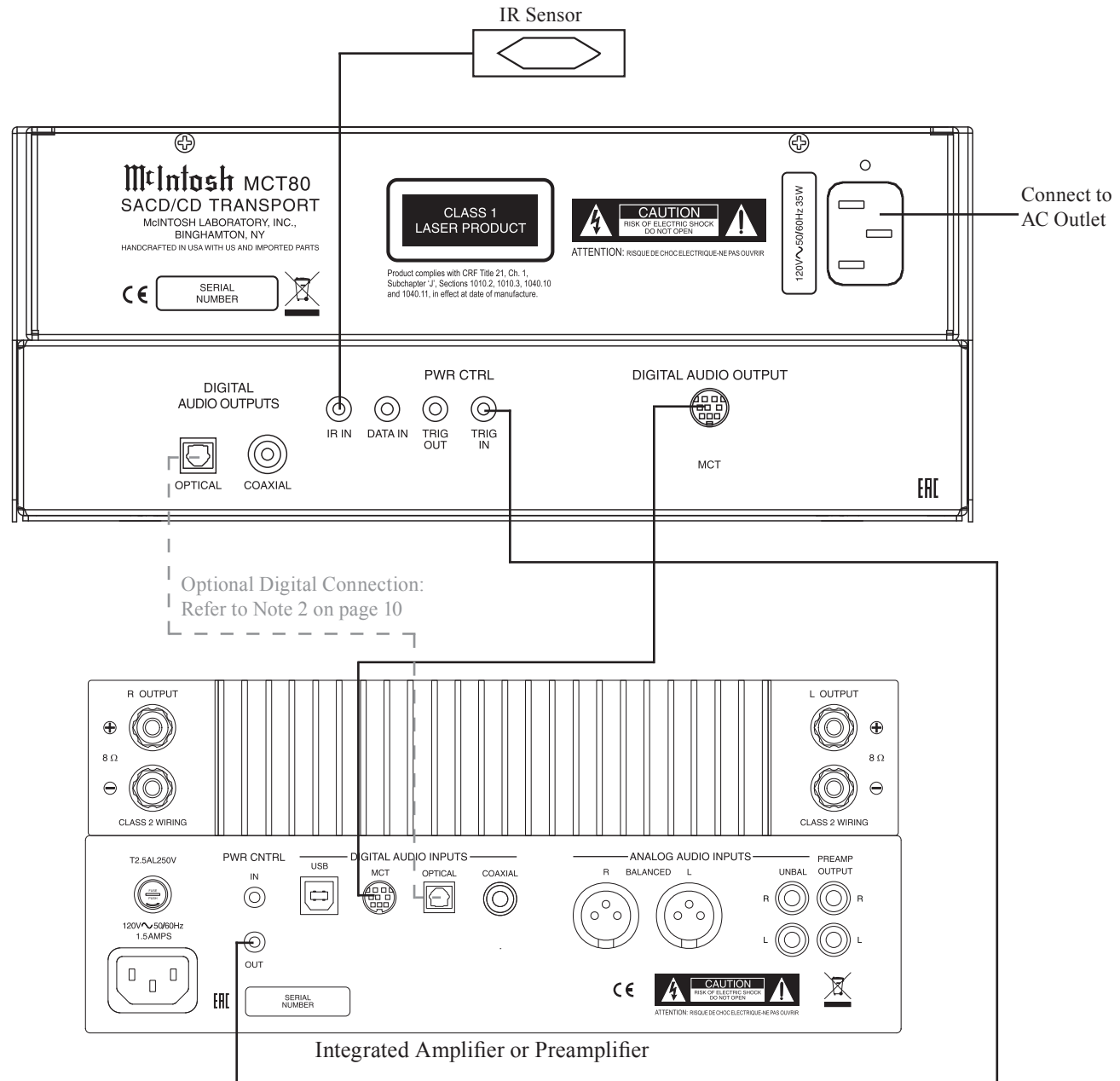

Selects the SACD or CD Audio Tracks from a hybrid disc

Disc Tray opens to load and unload a disc

Opens and Closes the disc tray for loading or unloading discs

IR Sensor receives commands from a Remote Control

Starts disc playback and pauses disc playback

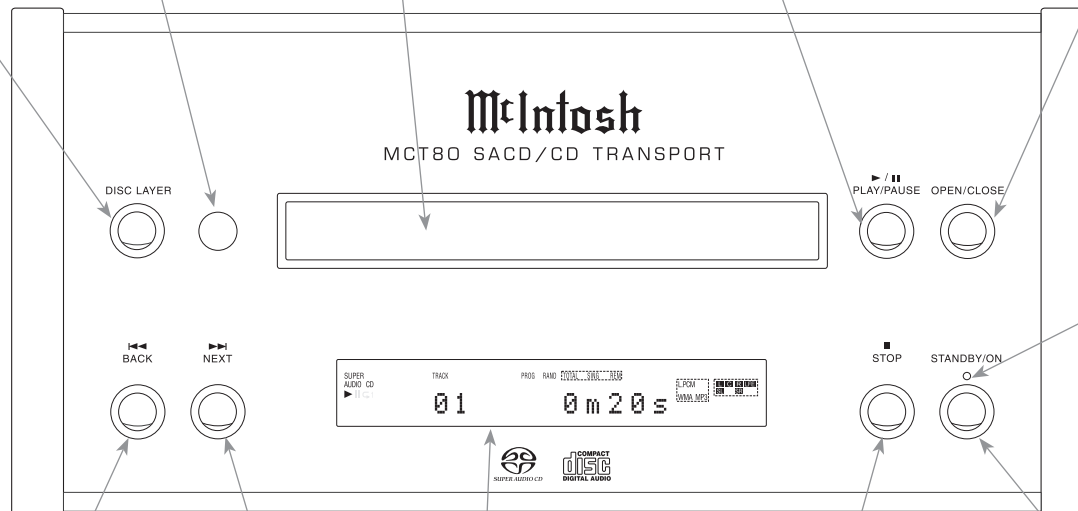

Standby Power On Indicator and the color indicates the status of the Auto Off Feature

Move backward one track at a time

Move forward one track at a time

Front Panel Display indicates various operation functions and times

Stops disc playback

STANDBY/ON Push-button switches the MCT80 ON or OFF (Standby)

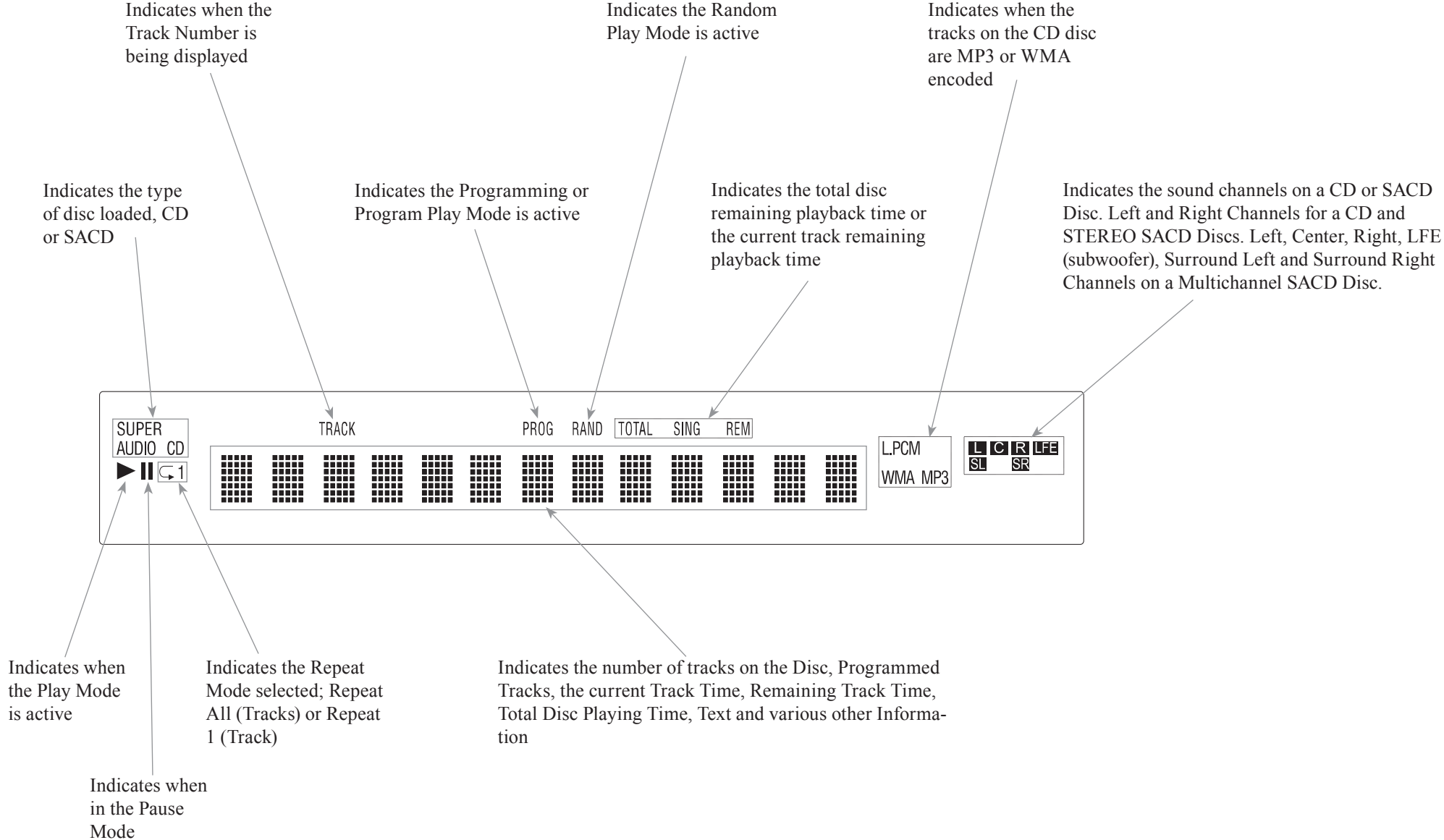



Remote Control Push-Buttons for CD Disc and SACD Disc Playback

SHIFT push-button with LED Indicators used to select a push-button function with white or gold color nomenclature

Use to CLEAR the last programmed track

Access the TEXT Display Mode when playing a SACD Disc containing the information

Use to select various disc information, including time, on the Front Panel DISPLAY. It is also used to cancel the text display mode on a SACD Disc

Use to select the SACD or CD Tracks from a hybrid disc for playback

Press Back to reverse playback of the Previous Selection. Also used to select one of various repeat modes

Press once to PLAY, a second time to PAUSE and a third time to RESUME playback. Also used to activate random playback of the tracks on a SACD or CD disc

Press to FAST-REVERSE thru the current selection

Momentarily press to Power ON or OFF

DIM push-button to adjust the brightness of the Front Panel Information Display

Use to select disc tracks or any numbered operation

Push-button 5 used to Enter the track/folder indicated on the McIntosh Front Panel Display

Use to direct access tracks 10 and above

Selects Disc MODE or Folder Mode for navigating and selection of music tracks (MP3 or WMA) on a CD-ROM Disc

Press to play the NEXT Selection

Press to FAST-FORWARD thru the current selection

Press to STOP disc playback

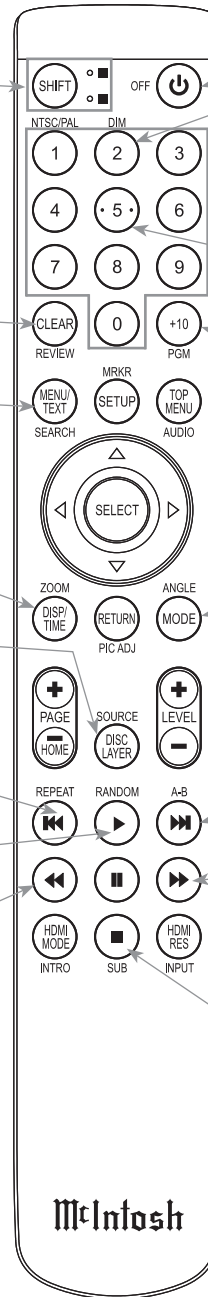

Note: The Remote Control Push-buttons not identified are for use with other McIntosh Products

How to use the Remote Control for CD Disc and SACD Disc Playback

The Remote Control is capable of performing most Operating Functions for the MCT80 SACD/CD Transport.

Note: Refer to the "How to Operate" Section of this manual for additional information using this Remote Control.

Dual Function Remote Control Push-buttons

If at any time the HR086 Remote Control seems unresponsive to the desired Remote Control Command, it may be necessary to select the color of the Push-button nomenclature for the desired command. This is accomplished by first pressing the SHIFT Push-button to select either white or gold, as indicated by the adjacent LEDs, and then within 3 seconds pressing, or in the case of some functions repeatedly pressing, the desired command push-button.

Play

With a disc loaded, press the PLAY▶ Push-button to start the disc playing. Press the PLAY▶ Push-button a second time to temporarily stop disc playback at any time (Pause).

Note: The Play and Pause functions have been combined into the Play Push-button.

Stop

Press the STOP■ Push-button to stop disc playback and return to displaying the table of contents of the disc.

Numbered Push-buttons

Press 1 through 9 to directly access one of the first nine Disc Tracks using the Front Panel Information Display. For track numbers greater than 10, press the

+10 Push-button followed by the 0-9 Push-button. For example, to access Disc Track 23, press the +10 Push-button twice and then the 3 Push-button.

Reverse and Fast Forward

Press the ◀◀ (Reverse) or ▶▶ (Fast Forward) Push-button to start moving rapidly through a track on the disc. When the desired location is reached release the ◀◀ (Reverse) or ▶▶ (Fast Forward) Push-button to resume normal playback.

Back and Next

Press the ▶▶ (Next) Push-button to move forward one track or the ◀◀ (Back) Push-button to move back to the beginning of the current track playing. Also used to review the Programmed Tracks from the disc on the Front Panel Information Display, while in the Program Mode.

Note: If the ◀◀ (Back) Push-button is pressed during playback of the first three seconds of the track, the MCT80 will start playing back the previous track from the beginning. If the Front Panel Information Display is indicating time, the display will momentarily indicate the track number.

SACD or CD Track Selection

Press the DISC LAYER Push-button to select the SACD or CD Tracks from a hybrid disc for playback.

Display/Time

Press the DISPlay/TIME Push-button to access various disc times. It is also used to return the Front Panel Information Display to indicate time instead of text information on a SACD Disc.

Menu/Text

Press the MENU/TEXT Push-button to select the various text information on a SACD Disc such as Album, Artist and Track Titles (disc dependent).

Repeat Modes

Press the REPEAT Push-button to select either One Track, All Tracks or cancel the Repeat Mode.

Clear

Press the CLEAR Push-button to erase a program track(s).



Remote Control Push-Buttons for Playback of Data CD and Data DVD Disc

SHIFT push-button with LED Indicators used to select a push-button function with white or gold color nomenclature

Refer to page 22 for information on the use of Push-buttons 2, 4, 5, 6 and 8 for playback of Data CD and Data DVD Disc

Access the TEXT Display Mode when playing back a music track

Refer to page 22 for information on the use of DISPLAY/TIME Push-button for playback of Data CD and Data DVD Disc

Press Back to play the Previous Selection. Also used to select one of various repeat modes

Press once to PLAY, a second time to PAUSE and a third time to RESUME playback. Also used to activate random playback of the tracks

Press to FAST-REVERSE thru the current selection

Momentarily press to Power ON or OFF

Selects the ALL or FOLDER Operational Modes for playback of Data Disc CD or DVD

LEVEL Control adjusts the volume level for the Rear Panel Variable Audio Output Connectors and the Front Panel Headphone Jack

Press to play the NEXT Selection

Press to FAST-FORWARD thru the current selection

Press to STOP playback

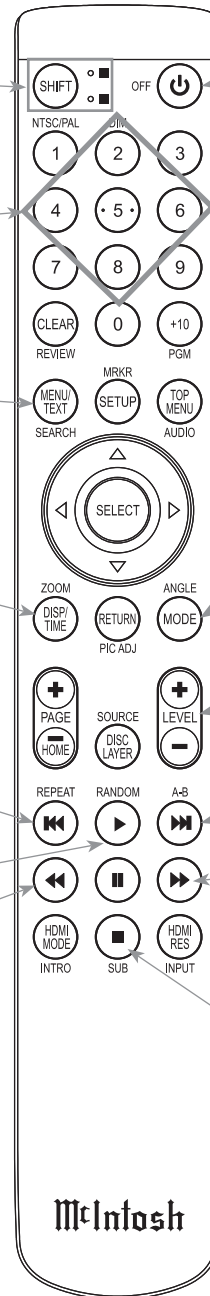

Note: The Remote Control Push-buttons not identified are for use when playing back CD/SACD Discs (refer to page 14) or for use with other McIntosh Products

How to use the Remote Control for Playback of Data CD Disc and Data DVD Disc

The Remote Control is capable of performing most Operating Functions for Data Disc on the MCT80.

If at any time the Player seems unresponsive to the desired Remote Control Command, it may be necessary to select the color of the push-button nomenclature for the desired command. This is accomplished by first pressing the SHIFT Push-button to select gold, as indicated by the LED, and then within 3 seconds pressing (or in the case of some functions repeatedly pressing) the desired command push-button.

Note: Refer to the "How to Operate" Section of this manual for additional information using this Remote Control.

Remote Control Button Functions

When playing a Data CD Disc or Data DVD Disc, some of the Remote Control Push-buttons that are labeled for stand CD and SACD Operation Functions will also perform different additional Operation Functions.

Playback Operation Mode

The MCT80 has different Operational Playback Modes when a Disc contains DATA MUSIC FILES. The Operational Mode Selection includes the "All Mode" and the "Folder Mode" which are indicated by the Front Panel Display, refer to figures A and B.

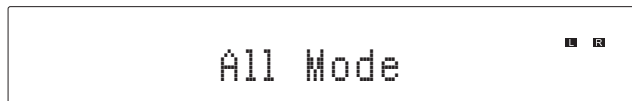

Figure A



Figure B

To check the current Operation Mode press the MODE Push-Button on the Remote Control once. To change the current Operation Mode, press the MODE Push-Button on the Remote Control twice, followed by pressing the PLAY▶ Push-button on the Remote Control to activate the selected Operation Mode.

When conventional CD or SACD DISCs are played, all the sound tracks are sequentially numbered and are played back in that numeric order. This standard playback mode is referred to as the "All Mode" of operation.

CD Data and DVD Data Discs containing DATA sound tracks are usually created on a computer which can create multiple Folders that are in a sequential order. Each folder can contain multiple sound tracks that are in a sequential order. This playback mode is referred to as the "Folder Mode" of operation. Refer to "Front Panel Display" for sample Front Panel Indications of the Folder Mode content.

For additional information on the playback of CD Data and DVD Data Discs DATA sound tracks in the Folder Mode of Operation, refer to page 22.

Front Panel Display

When playing a Data CD Disc or Data DVD Disc containing DATA MUSIC FILES, the MCT80 Front Panel Information Display will also indicate the following:

- Folder or Sub-Folder Name - Music One
- Artist Name - Freddie King
- Album Name - Getting Ready
- Track Name - 09 Tore Down
- Audio Format Type and Sampling Frequency - WAV 44.1kHz

Upper and Lower Symbol

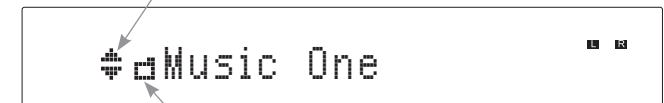

Folder Symbol



Music Symbol

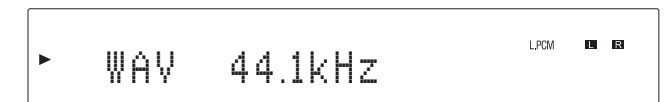
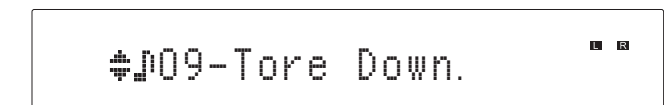
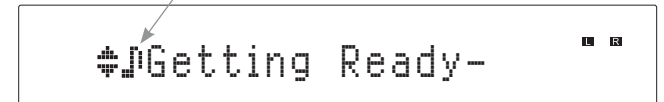



How to Operate the MCT80

Power On and Off

The LED above the STANDBY/ON Push-button lights to indicate the MCT80 is connected to AC Power. Refer to figure 1. The LED also indicates the status of the Auto Off Feature. When the MCT80 is in the Standby Mode, green illumination indicates the Auto Off Feature is enabled (default setting) and red illumination indicates the Auto Off Feature is disabled. For additional information refer to “Power Mode” on page 20.



Figure 1

Note: When AC Power is initially applied to the MCT80, the unit will momentarily switch On and then go into the Standby Mode.

To Switch ON the MCT80, momentarily press the STANDBY/ON Push-button on the Front Panel or the (Power) Push-button on the Remote Control. Refer to figures 2 and 21. The LED above the STANDBY/ON Push-button illuminates green. LEDs above the MUTE and INPUT Push-buttons will illuminate. The Front Panel Display will momentarily indicate “DISC” followed by “READING” and then “NO DISC”. Refer to figures 2, 3, 4, 5 and 21. To switch OFF the MCT80, momentarily press the STANDBY/

ON Push-button on the Front Panel or the OFF Push-button on the Remote Control.

DISC READING NO DISC

Figure 3

Figure 4

Figure 5

How to Load and Unload a Disc

1. Press the OPEN/CLOSE Push-button. The disc tray will slide out allowing a CD Disc to be loaded. Refer to figure 6.
2. Press the OPEN/CLOSE Push-button and the disc tray will close. Refer to figure 7. Loading of the CD Disc’s Table of Contents (number of tracks and total playing time) will be indicated on the Front Panel Display. Refer to figure 8.

OPEN

Figure 6

CLOSE

Figure 7

Note: When a Disc is placed in the tray and the PLAY/PAUSE Push-button is pressed, the tray will close and the first track will start playing.

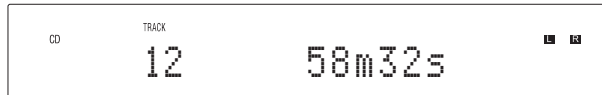

Figure 8

3. Pressing the OPEN/CLOSE Push-button will stop playback of the disc and the disc tray will open.

How to Play a SACD Disc

Load a SACD Disc into the MCT80. The Front Panel Display will first scroll the Album Title of the SACD Disc (available on most SACD Discs). Refer to figures 9, 10 and 11.



Figure 9

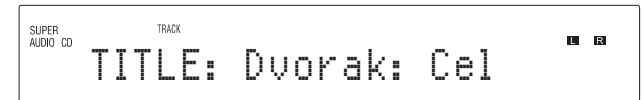

Figure 10

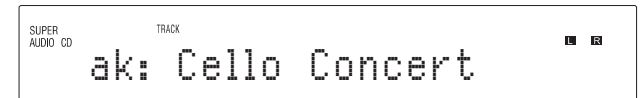

Figure 11

The Album Title is followed by the Table of Contents. Refer to figure 12.

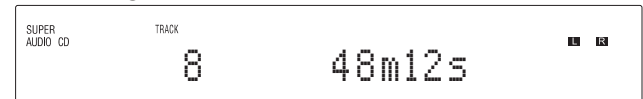

Figure 12

Press the PLAY/PAUSE ►/|| Push-button on the Front Panel of the MCT80 or Remote Control. Refer to figures 2 and 21. The Disc will start playing the first track of the SACD Layer.

Note: The default setting for SACD/CD Hybrid Disc is to play the SACD Stereo Layer. The default setting may be changed to play the CD Layer or the SACD Multichannel Layer, when available. With the MCT80 On and no disc loaded, press the DISC LAYER Push-button until the Front Panel Display indicates the desired layer.

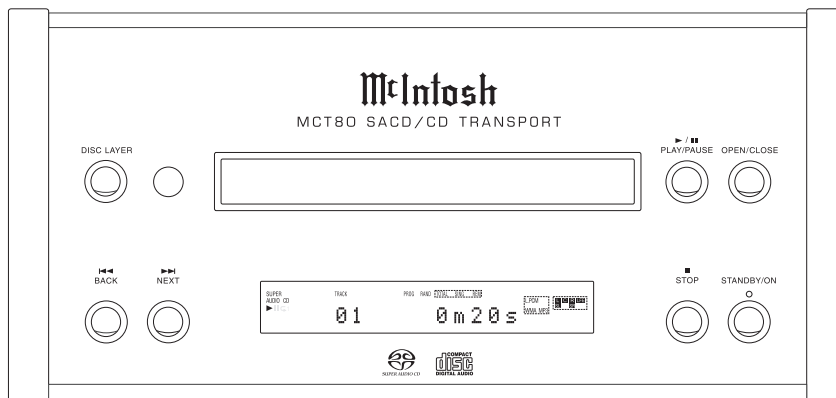

Figure 2

Selection of a different Layer (CD, Stereo or Multichannel) can occur during playback of a disc by pressing the DISC LAYER Push-button once to see the current selection and a second or third time to select the desired Layer. Refer to figures 13, 14 and 15. The Player will stop playing the current Layer and then load the desired Layers' Table of Contents (Number of tracks and Total Playing Time). Once the information is indicated on the front panel display, press the PLAY/PAUSE ►/|| Push-button. Refer to figure 16.

STEREO

Figure 13

MULTI

Figure 14

CD

Figure 15

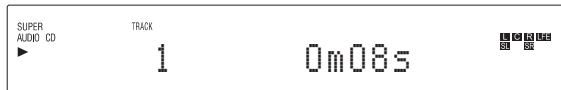

Figure 16

Note: 1. Most SACD Discs have the ability of displaying the Album Title and Artist. With the disc loaded, SACD Table of Contents read and the disc stopped, press the MENU/TEXT Push-button once for scrolling the Title and twice for scrolling the Artist Name. Display of the Artist information is not available during playback of the disc. Refer to figures 17, 18 and 21.



Figure 17

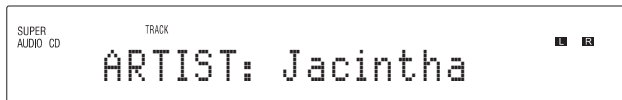

Figure 18

2. In a similar manner, some SACD Discs have the ability of scrolling the Track Number and Title by pressing the MENU/TEXT Push-but-

ton after the Track has started to play. Refer to figures 19 and 21.

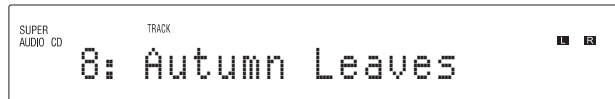

Figure 19

3. The Text Display Mode may be canceled by pressing the DISP/TIME Push-button on the Remote Control. Refer to figure 21.
4. The various Time Modes may be displayed by pressing the DISP/TIME Push-button on the Remote Control. Refer to figure 21. For additional information on the Time Display Modes refer to "Display Modes" on page 20.
5. SACD Discs containing Multichannel sound will not produce output when this layer is selected because the MCT80 is a two channel (stereo) unit.

How to Play a CD Disc

With a disc already loaded into the MCT80, press the PLAY/PAUSE ►/|| Push-button on the Front Panel of the MCT80 or Remote Control. Refer to figures 2, 20 and 21.

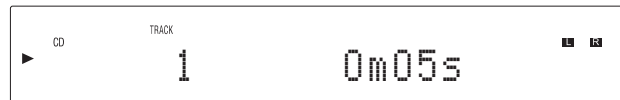

Figure 20

How to Pause a Disc

This feature allows for the temporary stopping of disc playback. Refer to figures 2, and 16.

1. When playing a Disc, press the PLAY/PAUSE ►/|| Push-button to temporarily stop playback.
2. Press the PLAY/PAUSE ►/|| Push-button to resume playing the disc.

Track Back

Return to the beginning of the Track currently playing by momentarily pressing the ◀◀ Back Push-button. Press and hold the ◀◀ Back Push-button for rapid selection of the desired previous Tracks. Refer to figures 2 and 21.

Track Next

Advance to the next Track by pressing the ▶▶ Next Push-button. Press and hold the ▶▶ Next Push-button for rapid selection of the next desired Track. Refer to figures 2 and 21.

Fast Forward or Reverse

Using the Remote Control, press the ▶▶ (Fast Forward) or ◀◀ (Reverse) Push-button to search back and forth rapidly through a Track on a disc. To return to normal playback release the same ▶▶ (Fast Forward) or ◀◀ (Reverse) Push-button. Refer to figure 21.

Stop Mode

Press the STOP ■ Push-button at any time to stop Playback. To listen to the disc again, press the PLAY/PAUSE ►/|| Push-button and playback will start from the beginning of the disc.

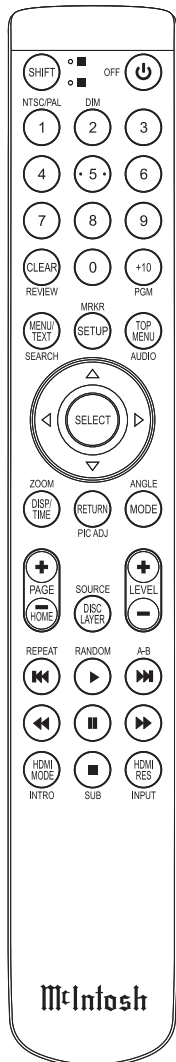

Figure 21



How to Operate the MCT80, con't

Direct Track Selection

The MCT80 Front Panel Display indicates the Disc Track currently playing. Use the Remote Control NUMERIC Push-button(s) to enter the desired Track Number. Refer to pages 14 and 15 for additional information using the Remote Control.

Repeat

This allows repeating a Track, Disc, Program Mode or Random Play Mode on a continuous basis. Refer to figures 2 and 25.

1. With the disc playing (Regular, Program or Random Playback Modes), press the REPEAT Push-button once to activate the Track Repeat (G1); press the REPEAT Push-button twice to activate the Disc Repeat (G2). Refer to figures 23 and 24.



Figure 23



Figure 24

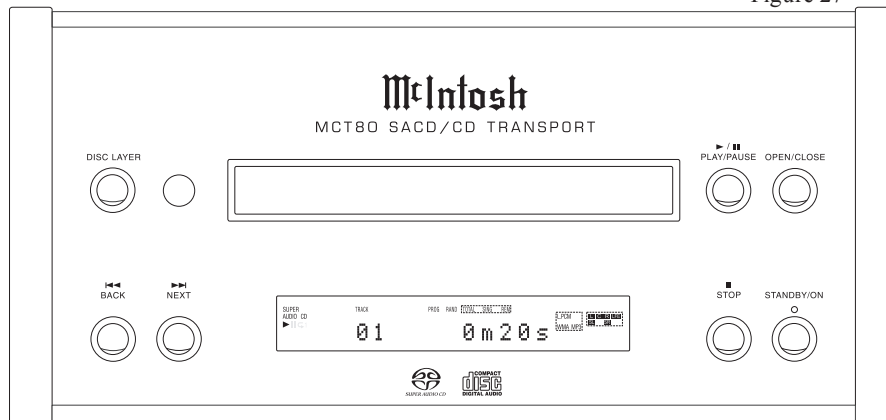

Figure 2

2. To cancel the previously selected Repeat Mode, press the REPEAT Push-button until the character "1" and/or the symbol "G" in the Front Panel Information Display is extinguished.

Random Playback

This feature allows for listening to Tracks of a Disc in a Random Order. Refer to figure 25.

Note: Before the Random Playback Mode feature on the MCT80 can be activated, the disc must be stopped or the message "Press ■ (stop) first" will momentarily appear on the Front Panel Display. Refer to figure 26.

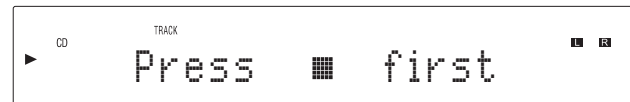

Figure 26

1. With the MCT80 in the STOP ■ Mode press the RANDOM Push-button. The word RANDom will be indicated in the Front Panel Display. Refer to figure 27.

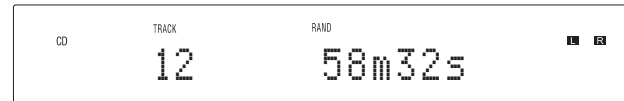

Figure 27

2. Press the PLAY/PAUSE ►/⏸ Push-button to start Random Playback. After all the tracks have been played the MCT80 will stop.

Notes: 1. To provide continuous playback of the disc, press the REPEAT Push-button twice to activate the Disc Repeat (G2) after the Random Playback Mode has started. If Repeat (G1) is selected, the current track will repeat.

2. The NEXT TRACK ►► function will advance to the next random selection and start playing.

3. To cancel the Random Playback Mode, press the STOP ■ Push-button, then press the RANDOM Push-button twice.

Program Playback

This feature allows for playback of selected Tracks on a Disc in the desired order. In the following example, a Disc is programmed to play Track 6 followed by Track 4 and then Track 2.

Notes: 1. The MCT80 must be in STOP Mode with the Disc TOC (Table of Contents) read before the Program Playback Mode Feature can be activated.

2. When programming Hybrid SACD Discs, first choose the layer (SACD or CD) so the correct TOC can be read, as some discs have different selections for the SACD and CD Tracks.

1. Press the RANDOM Push-button twice to access the Program Mode. Refer to figures 2, 25 and 28.
2. Enter the first desired selection (track 6) using the Numeric Push-buttons. The Front Panel Display

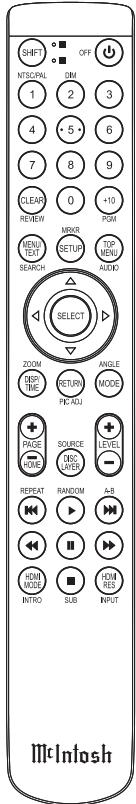

Figure 25

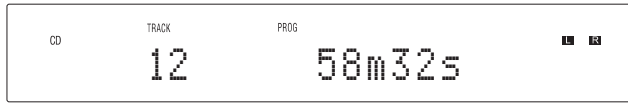

Figure 28

will first indicate track 6 followed by indicating the total number of tracks and total playback time for the current program. Refer to figures 29 and 30.



Figure 29



Figure 30

3. In a similar manner, enter the remaining Tracks 4 and 2. Refer to figures 31 thru 34.

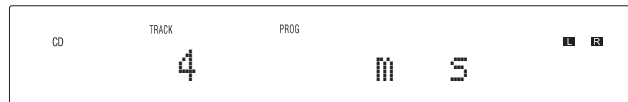

Figure 31

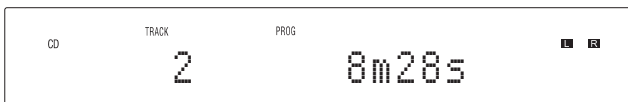

Figure 32

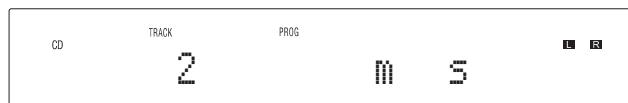

Figure 33

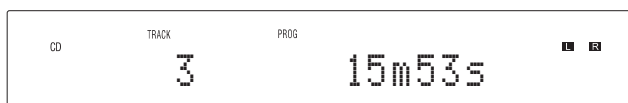

Figure 34

Note: To view and/or delete the selections programmed, use the TRACK NEXT ►► Push-button to step through programmed tracks and the CLEAR Push-button to remove any unwanted selections.

4. To start playback of the just entered program, press the PLAY/PAUSE ►/ || Push-button. Refer to figure 35.

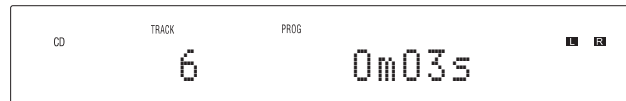

Figure 35

After playback begins, the Repeat Mode can be activated to provide continuous playback of the Programmed Track(s). Refer to figure 25.

Note: To momentarily stop playback, press the PLAY/PAUSE ►/ || Push-button. To resume Program Playback press the PLAY/PAUSE ►/ || Push-button.

5. To cancel the Program Playback Mode, press the STOP ■ Push-button followed by pressing the RANDOM Push-button.

Once the Program Playback Mode is active, tracks may be added or deleted by first pressing the STOP ■ Push-button followed by entering the additional tracks using the Numeric Push-buttons or delete the last track programmed by using the CLEAR Push-button.

MP3/WMA Disc Playback

The MCT80 has the ability of playing back MP3 and WMA encoded discs. MP3 and some version of WMA coding allow more tracks on the Disc by using the technique of lossy compression applied to the original audio information. These Tracks have lower audio quality than the original recording. Load a MP3/WMA disc into the MCT80. Refer to figure 36.



Figure 36

The MCT80 has two MP3/WMA Modes of Operation: Disc Mode and Folder Mode. Refer to figures 37 and 38.



Figure 37

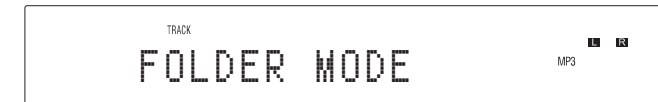

Figure 38

Select the desired mode by pressing the MODE Push-button on the Remote Control.

The Disc Mode will play back all the tracks on the disc starting with tracks not in folders first, followed by the track contained in the folder second. The Folder Mode will playback the tracks contained in the selected folder. Refer to figure 39.



Figure 39

1. Press the PLAY/PAUSE ►/ || Push-button to start Playback. Refer to figure 40.

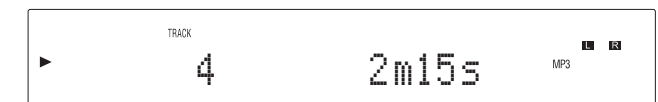

Figure 40

After all the tracks have been played the MCT80 will stop.

Note: Use the ▲ up and ▼ down directional Push-buttons to select folders on the disc.

How to Operate the MCT80, con't

Playback of Data Disc

Load a DATA Disc CD or DVD into the MCT80. The Front Panel Display will then indicate when a Data Disk has been inserted into the MCT80. For additional information refer to pages 16 and 17.

After the Folder Mode has been selected, the Front Panel Information Display will indicate the Folders, Sub Folders and Tracks. It also indicates the Album Name, the Artist Name, the Track Name, the Track Time, along with the Audio Format Type and Sampling Frequency. Due to the operational differences of various computers and the MCT80, sequel listing of the Folders, Sub Folders and Tracks will usually be different. If the All Mode on the MCT80 was selected the sequential listing will also be different.

Starting Playback

1. Using the Remote Control, press the Number 5 Push-button to start playback.
2. If the desired track for playback is located in a different folder, first press the Number 4 Push-Button. Then use the Number 2 (select the Upper▲ Data Folder) or Number 8 (select the Lower▼ Data Folder) Push-Button to select the desired Folder. Select the desired Track using the Number 2 or Number 8 Push-button. Once the Desired Track Name is indicated on the Front Panel Information Display, press the Number 5 Push-button to start playback of the track.

Note: Once the desired folder has been selected the Remote Control NEXT ►► Push-button can be used to select the desired track. Then the Remote Control PLAY ► Push-button when pushed will start playback of the track.

3. While the track just selected is playing back, the Front Panel Display may also indicate the Track Name, followed by the Artist Name and/or the Album Name by pressing the MENU/TEXT Push-button several times.
4. Press the DISPLAY/TIME Push-button (once or twice) to indicate on the Front Panel Display, the Audio Format Type and Sampling Frequency of the track that is playing back.

Selection of a Different Sub Folder

1. Press the Number 4 Push-button. The Front Panel Display will indicate the name of the current Folder.
2. Press the Number 2 Push-Button to select an Upper▲ Data Folder or press the Number 8 Push-Button to select a Lower▼ Data Folder. Once the desired folder has been selected, push the Number 6 Push-Button once to identify the first track in the folder. Press the Number 6 to start playing the first track from the selected folder or press the Number 6 a second time to start playing the second track.
3. Press the MENU/TEXT Push-button to display the Artist Name, followed by the Album Name and then the Track Name and Number.
4. Press the DISP/TIME Push-button to display the track number display time. Press the DISP/TIME Push-button a second time to display the Audio Format Type and the Sampling Frequency.

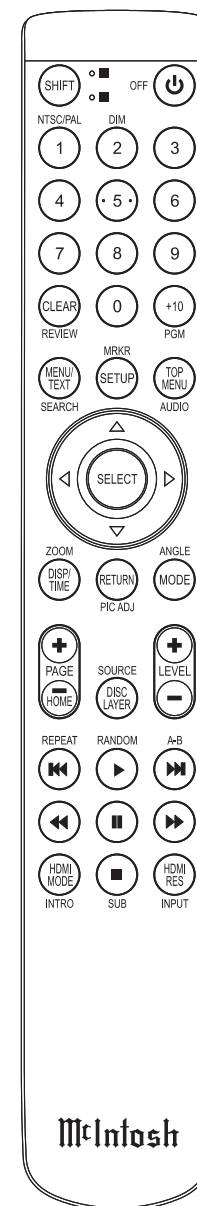

Figure 21

Display Modes

The MCT80 Front Panel Display indicates both track number and playing time. There are three playing time display indications: track elapse time, track remaining time or disc remaining time. To change from the default setting of track elapse time, press the DSP/TIME Push-button on the Remote Control. Refer to figures 21, 41, 42 and 43.



Figure 41



Figure 42



Figure 43

Display Brightness

There are three available Settings for the Front Panel Display. The choices include brightness settings of high (default setting), medium or low. To change the brightness setting perform the following steps and refer to figure 24:

1. Press the SHIFT Push-button.
2. Momentarily press the 2 (DIM) Push-button to change the current brightness setting. Repeat this until the desired brightness setting is selected.
3. Press the DISC LAYER Push-button to store the new brightness setting.

Power Mode

The MCT80 incorporates an Auto Off Feature, which can automatically place the SACD/CD Transport into the Power Saving Standby/Off Mode (default setting). This occurs approximately 30 minutes after there has been an absence of a Digital Audio Signal. If it is desirable to disable the Auto Off Feature, perform the following steps:

1. Using the MCT80 Remote Control, press and hold in the ⏻ (Power) Push-button for about 5-10 seconds, at which time the Front Panel Display indicates "Auto STBY Off". Refer to figure 44.



Figure 44

2. The MCT80 will switch Off and the LED above the STAND/BY Push-button will illuminate Red in color. Press the ⏻ (Power) Push-button to switch the MCT80 On.
3. To re-activate the Auto Off Feature, press and hold in the ⏻ Power Push-button on the Remote Control for about 5-10 seconds, at which time the Front Panel Display indicates "Auto STBY On". Refer to figure 45.



Figure 45

4. The MCT80 will switch Off and the LED above the STAND/BY Push-button will illuminate Green in color. Press the ⏻ (Power) Push-button to switch the MCT80 On.





How to Operate the MCT80, con't

Resetting the MCT80

FIRST PROCEDURE

In the unlikely event the MCT80 stops functioning, first try resetting the Main (System) Microprocessor by performing the following:

1. Switch Off the MCT80 by using the STANDBY/ON Front Panel Push-button. Then simultaneously press and hold in the Front Panel STANDBY/ON and DISC LAYER Push-button until the illumination of the LED above the STANDBY/ON Push-button goes Off.
2. Press the STAND/BY Push-button to switch the MCT80 back On.

Notes: 1. Resetting of the microprocessor also places the Power Saving Mode into the default setting of On.

2. If the MCT80 is not performing normally, perform the second procedure below.

SECOND PROCEDURE

If the MCT80 is still not functioning properly, reset the Secondary (Transport) microprocessor by performing the following:

1. Switch Off A.C. Power going to the MCT80.

Note: Temporarily, connect the AC Power Cord coming from the MCT80 into an AC Power Strip with an On/Off Switch. Position the AC Power Strip so the On/Off Switch on the strip is in very close proximity to the MCT80 Front Panel NEXT and STOP Push-buttons (the MCT80 Remote Control STOP Push-button will not work for resetting the micro).

2. Press and hold in the NEXT▶▶ and STOP■ Push-buttons while at the same time switching On the AC Power Strip.

3. The Front Panel Display will indicate “INITIALIZED” then release the NEXT▶▶ and the STOP■ Push-button.
4. When the Front Panel Display indicates “DISC” or “NO DISC”, press the STANDBY/ON Push-button to switch the MCT80 OFF. Now reconnect the MCT80 AC Power Cord the way it was connected before performing Step 1 *Note*, then switch the MCT80 back On.

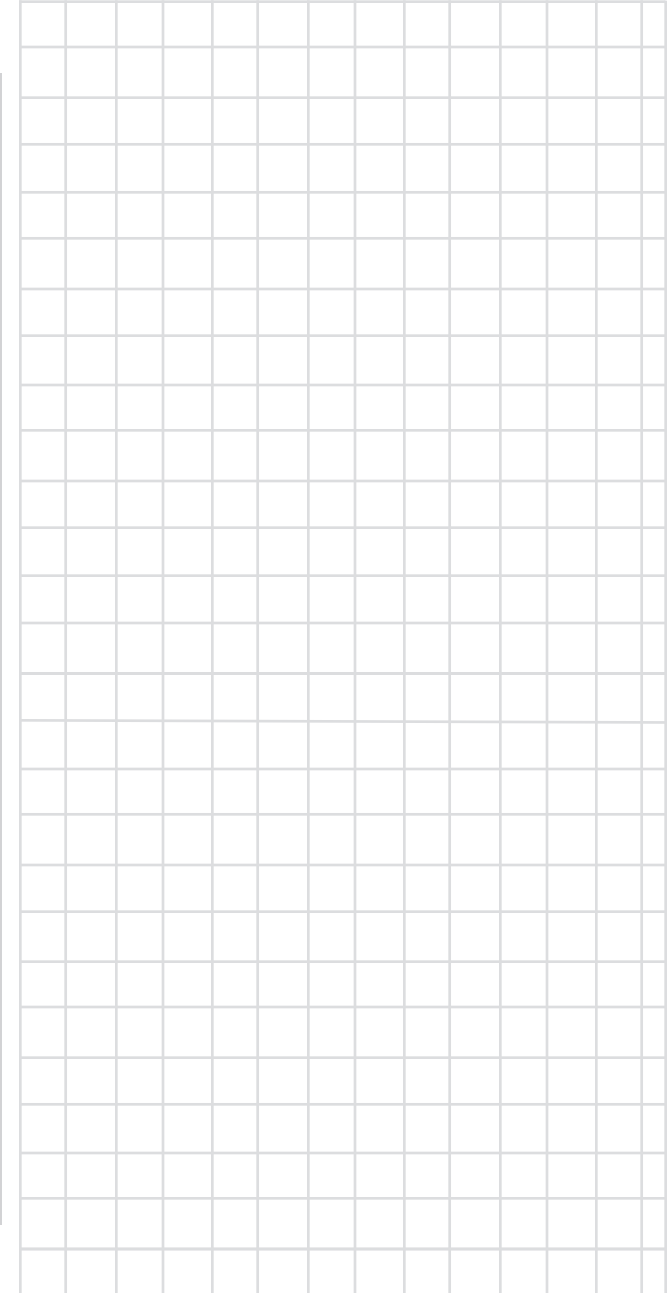





Digital Audio Specifications

Digital Audio Output Format

Coaxial and Optical: SPDIF (PCM¹), IEC958
44.1kHz to 192KHz/24Bit
Digital MCT: SPDIF (PCM¹), IEC958
44.1kHz to 96KHz/24-Bit
SACD DSD
Data DVD up to DSD128

Digital Audio Outputs

Coaxial: 0.5V p-p/75 ohms
Optical: - 15dbm to -21dbm (TOS Link)
Digital MCT: 3V @110 ohms

¹ PCM (Pulse Code Modulation) Digital Signal type used for CD Discs

² DSD (Direct Stream Digital) Digital Signal type used for SACD Discs

General Specifications

Transport

Laser Type: Twin Beam
Laser Beam Wavelength: 650nm (SACD)/790nm (CD)
Laser Power: CLASS IIa/CLASS I

Power Requirements

100 Volts, 50/60Hz at 35 watts
110 Volts, 50/60Hz at 35 watts
120 Volts, 50/60Hz at 35 watts
220 Volts, 50/60Hz at 35 watts
230 Volts, 50/60Hz at 35 watts
240 Volts, 50/60Hz at 35 watts
Standby: Less than 0.5 watt

Note: Refer to the rear panel of the MCT80 for the correct voltage.

Overall Dimensions

Width is 11-1/2 inches (29.2cm)
Height is 5-7/8 inches (14.9cm)
Depth is 19 inches (48.3cm) including the Front Panel and Cables

Note: When the Disc Tray is opened, the panel clearance required in front of mounting panel is 6-3/4 inches (17.2cm).

Weight

18.5 pounds (8.4Kg) net, 33 pounds (15.0Kg) in shipping carton

Shipping Carton Dimensions

Width is 26-1/2 inches (67.3cm)
Depth is 24-1/4 inches (62.2cm)
Height is 11-3/4 inches (29.9cm)

Packing Instructions

In the event it is necessary to repack the equipment for shipment, the equipment must be packed exactly as shown below. It is very important that the four plastic feet are attached to the bottom of the equipment.

This will ensure the proper equipment location on the bottom pad. Failure to do this will result in shipping damage.

Use the original shipping carton and interior parts only if they are all in good serviceable condition. If a shipping carton or any of the interior part(s) are needed, please call or write Customer Service Department of McIntosh Laboratory. Refer to page 3. Please see the Part List for the correct part numbers.

Quantity	Part Number	Description
1	033838	Shipping carton only
4	033837	End cap
1	033836	Inside carton only
1	033725	Top pad
1	034576	Bottom pad
4	017937	Plastic foot
4	400159	#10-32 x 3/4" screw
4	404080	#10 Flat washer

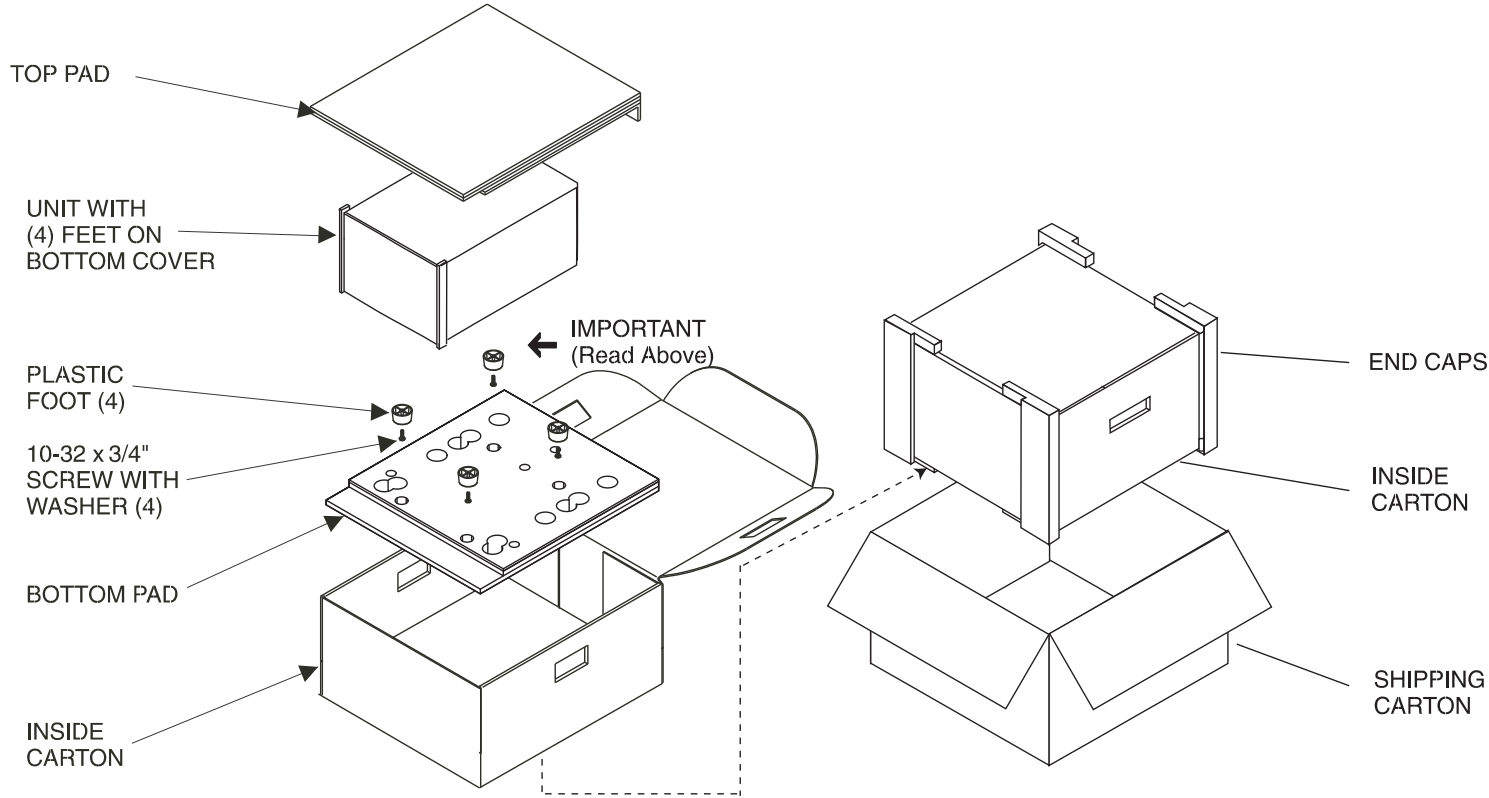



McIntosh Laboratory, Inc.
2 Chambers Street
Binghamton, NY 13903
www.mcintoshlabs.com

The continuous improvement of its products is the policy of McIntosh Laboratory Incorporated who reserve the right to improve design without notice.
Printed in the U.S.A.