



McIntosh Laboratory, Inc. 2 Chambers Street Binghamton, New York 13903-2699 Phone: 607-723-3512 www.mcintoshlabs.com

MX122
A/V Processor
Owner's Manual





Important Safety Information is supplied in a separate document “Important Additional Operation Information Guide”

FCC Information (For US Customers)

1. IMPORTANT NOTICE: DO NOT MODIFY

THIS PRODUCT

This product, when installed as indicated in the instructions contained in this manual, meets FCC requirements. Modification not expressly approved by McIntosh may void your authority, granted by the FCC, to use the product.

2. CAUTION:

- To comply with FCC RF exposure compliance requirement, separation distance of at least 20cm must be maintained between this product and all persons.
- This product and its antenna must not be co-located or operating in conjunction with any other antenna or transmitter.

3. COMPLIANCE INFORMATION:

- Product Name: A/V Processor
- Model Number: MX122
- **This product contains FCC ID:ZQO-CY92024C:**
McIntosh Laboratory, Inc.
2 Chambers Street
Binghamton, NY 13903
Tel. (607) 723-3512

IC Information (For Canadian Customers)

1. PRODUCT:

This product contains IC: 2581A-CY92024C

This product complies with RSS-210 of Industry Canada. Operation is subject to the following two conditions: (1) this product may not cause harmful interference, and (2) this product must accept any interference received, including interference that may cause undesired operation. This Class B digital apparatus complies with Canadian ICES-003.

2. CAUTION:

To reduce potential radio interference to other users, the antenna type and its gain should be so chosen that the equivalent isotropically radiated power (e.i.r.p.) is not more than that permitted for successful communication.

Informations sur IC (pour les clients Canadiens)

1. APPAREIL:

Cet appareil contient IC: 2581A-CY92024C

Cet appareil est conforme à la norme CNR-210 du Canada. L'utilisation de ce dispositif est autorisée seulement aux deux conditions suivantes : (1) il ne doit pas produire de brouillage, et (2) l'utilisateur du dispositif doit être prêt à accepter tout brouillage radioélectrique reçu, même si ce brouillage est susceptible de compromettre le fonctionnement du dispositif. Cet appareil numérique de la classe B est conforme à la norme NMB-003 du Canada.

2. ATTENTION:

Afin de réduire le risque d'interférence aux autres utilisateurs, il faut choisir le type d'antenne et son gain de façon à ce que la puissance isotrope rayonnée équivalente (p.i.r.e.) ne soit pas supérieure au niveau requis pour l'obtention d'une communication satisfaisante.

Canadian Customers: CAN ICES-3 (B)/NMB-3 (B) RF Exposure Information

This equipment complies with FCC/IC radiation exposure limits set forth for an uncontrolled environment and meets the FCC radio frequency (RF) Exposure Guidelines in Supplement C to OET65 and RSS-102 of the IC radio frequency (RF) Exposure rules. This equipment has very low levels of RF energy that are deemed to comply without testing of specific absorption ratio (SAR).

Cet équipement est conforme aux normes d'exposition aux radiations FCC/IC définies pour un environnement non contrôlé et satisfait les directives d'exposition à la radiofréquence (RF) dans le supplément C des OET65 et RSS-102 des règles d'exposition à la fréquence radio (RF) IC. Cet équipement a de très faibles niveaux d'énergie RF qui sont jugés conformes sans test de taux d'absorption spécifique (SAR).

R&TTE(EN) Information

1. DECLARATION OF CONFORMITY

Our products follow the provisions of EC/EU directives:
LV: 2006/95/EC
EMC: 2004/108/EC
RoHS: 2011/65/EU
ErP: EC regulation 1275/2008 and its frame work directive 2009/125/EC
R&TTE Directive 1999/5/EC.

2. IMPORTANT NOTICE: DO NOT MODIFY THIS PRODUCT

This product, when installed as indicated in the instructions contained in this manual, meets R&TTE directive requirements. Modification of the product could result in hazardous Radio and EMC radiation.

3. CAUTION:





Separation distance of at least 20cm must be maintained between this product and all persons. This product and its antenna must not be co-located or operating in conjunction with any other antenna or transmitter.



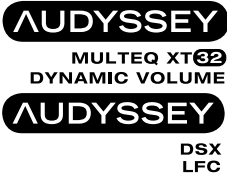

Trademark and License Information

The McIntosh MX122 incorporates copyright protected technology that is protected by U.S. patents and other intellectual property rights. The MX122 uses the following Technologies:

This item incorporates copy protection technology that is protected by U.S. patents and other intellectual property rights of Rovi Corporation. Reverse engineering and disassembly are prohibited.

PANDORA, the PANDORA logo, and the Pandora trade dress are trademarks or registered trademarks of Pandora Media, Inc. Used with permission.

Trademark Logo	License Information
	AirPlay®, the AirPlay logo, iPhone®, iPod®, iPod classic®, iPod nano®, iPod shuffle®, iPod touch® and iPad® are trademarks of Apple Inc., registered in the U.S. and other countries.
	<p>“Made for iPod” and “Made for iPhone” mean that an electronic accessory has been designed to connect specifically to iPod or iPhone respectively, and has been certified by the developer to meet Apple performance standards.</p> <p>Apple is not responsible for the operation of this device or its compliance with safety and regulatory standards. Please note that the use of this accessory with iPod, or iPhone, may affect wireless performance.</p> <ul style="list-style-type: none"> iPhone, iPod, iPod classic, iPod nano, iPod shuffle and iPod touch are trademarks of Apple Inc., registered in the U.S. and other countries. <p>Individual users are permitted to use iPhone, iPod, iPod classic, iPod nano, iPod shuffle, and iPod touch for private copy and playback of non-copyrighted contents and contents whose copy and playback is permitted by law. Copyright infringement is prohibited by law.</p>
	Manufactured under license from Audyssey Laboratories. U.S. and foreign patents pending. Audyssey MultEQ® XT32, Audyssey Dynamic EQ®, Audyssey Dynamic Volume® and Audyssey DSX® and Audyssey LFC™ are registered trademarks of Audyssey Laboratories.
	The Bluetooth® word mark and logos are registered trademarks owned by Bluetooth SIG, Inc. and any use of such marks by McIntosh Group, Inc. is under license. Other trademarks and trade names are those of their respective owners.

Trademark Logo	License Information
	The Wi-Fi CERTIFIED logo is a registered trademark of the Wi-Fi Alliance. Wi-Fi Certification provides assurance that the device has passed the interoperability test conducted by the Wi-Fi Alliance, a group that certifies interoperability among wireless LAN devices.
	Manufactured under license from Dolby Laboratories. Dolby, Dolby Atmos, Dolby Surround, and the double-D symbol are trademarks of Dolby Laboratories.
	For DTS patents, see http://patents.dts.com . Manufactured under license from DTS, Inc. DTS, the Symbol, DTS in combination with the Symbol, DTS:X, and the DTS:X logo are registered trademarks or trademarks of DTS, Inc. in the United States and/or other countries. © DTS, Inc. All Rights Reserved.
	Manufactured under license from Auro Technologies. Auro-3D® and the related symbols are registered trademarks of Auro Technologies. All materials contained in this work are protected by copyright law and may not be reproduced, distributed, transmitted, displayed, published or broadcast without the prior written permission of Auro Technologies NV or in case of third party materials, the owner of that content. You may not alter or remove any trademark, copyright or other notice from copies of the content. Auro Technologies: mail info@auro-technologies.com , phone +32-(0)-14314343, fax +32-(0)-14321224, www.auro-technologies.com .
	HDMI, the HDMI Logo and High-Definition Multimedia Interface are trademarks or registered trademarks of HDMI Licensing LLC in the United States and other countries.



Thank You

Your decision to own this McIntosh MX122 A/V Processor ranks you at the very top among discriminating music listeners. You now have “The Best.” The McIntosh dedication to “Quality,” is assurance that you will receive many years of musical enjoyment from this unit.

Please take a short time to read the information in this manual. We want you to be as familiar as possible with all the features and functions of your new McIntosh.

Please Take A Moment

The serial number, purchase date and McIntosh Dealer name are important to you for possible insurance claim or future service. The spaces below have been provided for you to record that information:

Serial Number: _____

Purchase Date: _____

Dealer Name: _____

Technical Assistance

If at any time you have questions about your McIntosh product, contact your McIntosh Dealer who is familiar with your McIntosh equipment and any other brands that may be part of your system. If you or your Dealer wish additional help concerning a suspected problem, you can receive technical assistance for all McIntosh products at:

McIntosh Laboratory, Inc.
2 Chambers Street
Binghamton, New York 13903
Phone: 607-723-3512
Fax: 607-724-0549

Customer Service

If it is determined that your McIntosh product is in need of repair, you can return it to your Dealer. You can also return it to the McIntosh Laboratory Service Department. For assistance on factory repair return procedure, contact the McIntosh Service Department at:

McIntosh Laboratory, Inc.
2 Chambers Street
Binghamton, New York 13903
Phone: 607-723-3515
Fax: 607-723-1917

Table of Contents

Safety Instructions.....	2
(Separate Sheet).....	Important Additional
	Operation Information Guide
Trademark and License Information.....	3
Thank You and Please Take a Moment.....	4
Technical Assistance and Customer Service.....	4
Table of Contents.....	4
General Information.....	5
Connector and Cable Information.....	6
Introduction.....	7
Performance Features.....	7
Dimensions.....	8
Installation.....	9
Connections:	
Rear Panel Connections.....	10
Connections Diagram (Separate Sheet).....	Mc1A
MX122 Main Zone Input Connections.....	11
Connection Diagram (Separate Sheet).....	Mc2A
MX122 Main Zone Output Connections.....	12
Connection Diagram (Separate Sheet).....	Mc2B, Mc3A
MX122 Zone 2 Input and Output Connections.....	13
Connection Diagram (Separate Sheet).....	Mc3B

Copyright 2017 © by McIntosh Laboratory, Inc.

Front Panel:

Front Panel Displays, Controls and Push-buttons.....	14
Diagram (Separate Sheet).....	Mc1B

Remote Control:

Remote Control.....	15
Push-buttons Functioning (Separate Sheet).....	Mc4A

Setup Mode:

Introduction to the MX122 Setup Mode.....	16-17
Audio Setup Menu.....	18-19
Video Setup Menu.....	19-20
Inputs Setup Menu.....	20-21
Speaker Setup Menu.....	21-22
Network Setup Menu.....	22-23
General Setup Menu.....	23-26
IR Sensor Settings.....	27
Initial Loudspeaker Setup.....	28
Audyssey Auto Setup Information.....	29
Audyssey Auto Setup Procedure.....	30-31
Audyssey Error Messages.....	32

Operation:

How to Operate the MX122.....	34-37
iPod Playback and AirPlay.....	37-38
USB Drive Playback.....	39
Internet Radio.....	40
Special Internet Media Streaming.....	41-42
Media Server.....	43
MX122 PC Guide.....	44
Resetting the Micro and Factory Default Settings.....	45

Additional Information:

Specifications.....	46
Packing Instruction.....	47

General Information

1. For additional connection information, refer to the owner’s manual(s) for any component(s) connected to the MX122 A/V Processor.
2. The Main AC Power going to the MX122 and any other McIntosh Component(s) should not be applied until all the system components are connected together. Failure to do so could result in malfunctioning of some or all of the system’s normal operations. When the MX122 and other McIntosh Components are in their Standby Power Off Mode, the Microprocessor’s Circuitry inside each component is active and communication is occurring between them.
3. Sound Intensity is measured in units called Decibels and “dB” is the abbreviation.
4. LFE (Low Frequency Effects) refers to the Dolby Digital or DTS sound channel dedicated to sound effects (such as explosions) and is usually reproduced by the Subwoofer. To hear bass frequencies below 80Hz, your system must include either a Subwoofer or Large Front Loudspeakers.
5. The MX122 processes Dolby Atmos, DTS-X and Auro-3D¹ Soundtracks. With these new soundtracks there are additional discrete channels of sound present. In this Owner’s Manual the number of channels are referred to as follows:

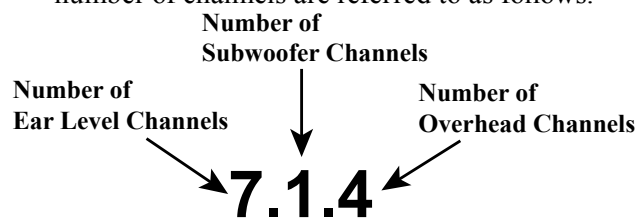

6. The advanced Digital Sound Processing Circuitry in the MX122 can output up to 11.2 discrete channels simultaneously.
- ¹ Auro-3D is not available for use in China and Japan. Auro-3D Sound Tracks are up to 10.1 Channels of playback.

7. The number of Pre-Amplifier Channel Output Connectors with Signals present is dependent upon many factors including the number of loudspeakers and their physical location in the room. The settings applied in the various MX122 Setup Modes and Operation Modes will also have an effect. Lastly, Audio/Video Source Components and program material itself will also determine the number of active channels with signals present.
8. MX122 is a three Zone Product (Main Zone, Zone 2 and Zone 3). This allows two different Audio/Video Sources to be available simultaneously for two separate rooms. Zone 2 may be used to provide an Audio/Video Output Signal for recording purposes, instead of an A/V signal to a second room. The Zone 3 (Audio Signal Sources only) allows for listening to a different Audio Source from either the Main Zone or Zone 2. For more information contact your McIntosh Dealer or McIntosh Technical Support.
9. The IR Input with 1/8 inch mini phone jack is compatible with IR sensors such as a Xantech Model DL85K Kit. Use a Connection Block such as a Xantech Model ZC21 when two or more IR sensors need to be connected to the MX122. To avoid possible interaction, disable the MX122 Front Panel Sensor. Refer to page 27.
10. The DATA OUT Jack can be connected via a "Y" Adapter to more than one McIntosh Source Component DATA-IN Jack.
11. Setup Mode operations should be performed in the order they appear in the first Setup Menu presented, as they are interactive.
12. The MX122 has built-in HDMI Digital Video Selection and Digital Video Processing Circuitry with Up Scaling capabilities to convert Composite

- or Component Video Signals to Digital Video.
13. On-Screen Overlays, Operational Menus and Setup Menu Functions are available on the HDMI OUT Connectors.
14. The Component Video and Composite Video Monitor Output Connectors provide a Video Signal when a Component Video and Composite Video Input Source with a signal present has been selected.
15. HDMI Cable lengths should not exceed 25ft (8.3m). If there is need to use HDMI Cables longer than 25ft (8.3m) use a high quality inline HDMI Buffer/Converter.
16. The MX122 is designed to pass through a 4K and 3D Digital Video Signal from a source component to a 4K and/or 3D TV/Monitor via the HDMI Connection that meets or exceeds the HDMI High Speed Cable Standards (2.0).
17. The MX122 is compatible with the following Apple Mobile Devices with the latest version of the Apple OS Software installed:

iPod touch (5th generation)	iPhone 5S
iPod touch (4th generation)	iPhone 5C
iPod touch (3rd generation)	iPhone 5
iPod touch (2st generation)	iPhone 4S
iPod classic	iPhone 4
iPod nano (7th generation)	iPhone 3GS
iPod nano (6th generation)	iPhone 3G
iPod nano (5th generation)	
iPod nano (4th generation)	
iPod nano (3rd generation)	
18. The Remote Control Supplied with the MX122 A/V Processor is capable of operating other components. For additional information go to www.mcintoshlabs.com.
19. For additional information on the MX122 and other McIntosh Products please visit the McIntosh Web Site at www.mcintoshlabs.com.

Connector and Cable Information

XLR Connectors

Below is the Pin configuration for the XLR Balanced Output Connectors on the MX122. Refer to the diagrams for connections.

- PIN 1: Shield/Ground
- PIN 2: + Signal
- PIN 3: - Signal

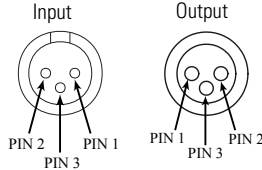

TRIGger (Power Control) Connectors

The MX122 Trigger Output Jacks send an On/Off signal from 0 to +12 volts with a total current up to 50mA when connected to other Components. A 3.5mm stereo mini phone plug is used for connection to the Trigger Outputs on the MX122.

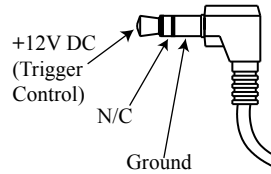

Data Output

The MX122 Data Out sends Remote Control Signals to Source Components. A 3.5mm mini phone plug is used for connection.

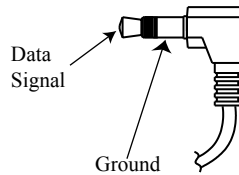

IR In Port Connector

The IR IN Port also uses a 3.5mm mini phone plug and allows the connection of external IR Receivers to the MX122.

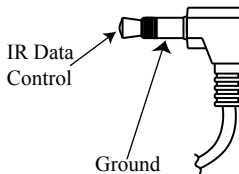

RS232 Connector

The RS232 Data Cable is a 3.5mm stereo mini phone plug to a subminiature DB 9 connector.

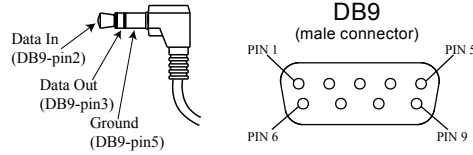

Ethernet RJ45 Socket

- | | |
|----------------------|---------------------|
| 1. Transmit Data (+) | 5. N/C |
| 2. Transmit Data (-) | 6. Receive Data (-) |
| 3. Receive Data (+) | 7. N/C |
| 4. N/C | 8. N/C |

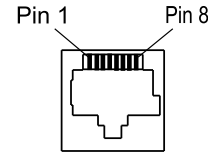

Ethernet Cable - Straight Thru Connections

Pin Number - Wire Color	→	Pin Number - Wire Color
1. Orange/White	→	1. Orange/White
2. Orange	→	2. Orange
3. Green/White	→	3. Green/White
4. Blue	→	4. Blue
5. Blue/White	→	5. Blue/White
6. Green	→	6. Green
7. Brown/White	→	7. Brown/White
8. Brown	→	8. Brown



Ethernet Cable - Crossover Connections

Pin Number - Wire Color	→	Pin Number - Wire Color
1. Orange/White	→	1. Green/White
2. Orange	→	2. Green
3. Green/White	→	3. Orange/White
4. Blue	→	4. Blue
5. Blue/White	→	5. Blue/White
6. Green	→	6. Orange
7. Brown/White	→	7. Brown/White
8. Brown	→	8. Brown



Introduction

The MX122 A/V Processor sets the standard of excellence in a Home Theater System. The MX122 provides superior multichannel reproduction, Audyssey® Room correction, the latest in digital audio decoding and digital video processing circuitry.

Performance Features

• Digital 4K and 3D Video Switching

There are seven HDMI 2.0a Inputs. Two Zone A HDMI Outputs including Digital Audio Return Channel (ARC) signal from the TV¹, thus eliminating the need for an extra cable and simplifies operation. HDMI inputs are compatible with HDCP 2.2, Deep Color, x.v.Color, Auto Lipsync and HDMI Component Control.

• Analog Video/Audio Switching with Scaling

Component Video Inputs and Composite Video Inputs (Analog Video Signals) are also converted to a Digital Video Signal with resolution up to 4K at the HDMI Outputs.

• Direct Access

There are 9 Analog (one eight channel input) and 11 Digital Audio Inputs along with 7 Analog and 7 Digital Video Inputs.

• Balanced Inputs and Outputs

A pair of Balanced high level Inputs and an 11.2 channel Balanced Output are provided, permitting long cable lengths without a loss in sound quality.

• Moving Magnet Phono Input

There is a Precision Phono Preamp for Moving Magnet Cartridges.

• Built-in Dolby Atmos, DTS-X and Auro-3D Master Decoders

The MX122 also provides built-in decoding of the Dolby True HD and DTS Master HD Sound Tracks.

• Internet Streaming

The MX122 when connected to a network, offers Internet Radio, with music and photo streaming.

• On-Screen and Multifunction Fluorescent Displays

A comprehensive On-Screen Display capability makes it easy to perform setup and operational adjustments using the Remote Control. The front panel display indicates input selection, volume levels, and other operating functions.

• LED Channel Status Indicators

The MX122 includes twenty-five LEDs on the front panel to indicate what type of operating signals are being received, signal processing mode and the output format chosen.

• Audyssey DSX®

Audyssey DSX is a scalable system that adds new speakers to improve surround impression. Audyssey DSX first adds Wide channels for the biggest impact on envelopment and then creates Height channels to reproduce the next most important acoustical and perceptual cues. Surround Envelopment Processing is used to enhance the blend between the front and surround channels.

• Digitally Controlled Volume and Tone Controls

A Precision Tracking Volume Control adjusts all twelve channels with tracking accuracy better than

0.5dB. The Bass and Treble circuits provide a wide range of tone shaping with no loss in traditional McIntosh sonic excellence.

• Triple Zones

The MX122 has the built-in ability to control a separate remote audio/video zone (Zone 2) with program selection independent of the Main Zone, using a dedicated power amplifier and speakers. There is also a third Zone (Zone 3) providing a separate audio only source to another room.

• Fiber Optic Solid State Front Panel Illumination

The Illumination of the Glass Front Panel is accomplished by the combination of custom designed Fiber Optic Light Diffusers and extra long life Light Emitting Diodes (LEDs). This provides even Front Panel Illumination and is designed to ensure the pristine beauty of the MX122 will be retained for many years.

• Triggers and Full Function Remote Control

The Triggers (Power Control) provide convenient Turn-On/Off of components connected to the MX122. The Remote Control Push-buttons provide complete control of the MX122 operating functions.

• Machined Side Panels

The sides of the MX122 are machined from thick aluminum panels with a smooth black finish.

• Special Power Supply

The Power Supply has Multiple Regulators to ensure stable noise free operation even though the power line varies.

¹ For TVs with ARC compatibility



Dimensions

The following dimensions can assist in determining the best location for your MX122.

Front View of the MX122

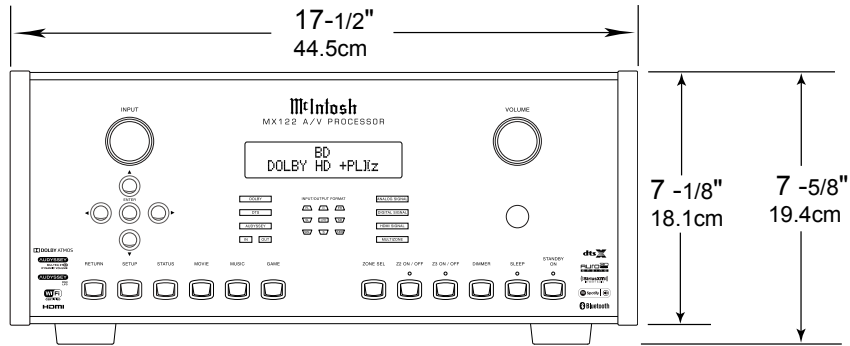

Side View of the MX122

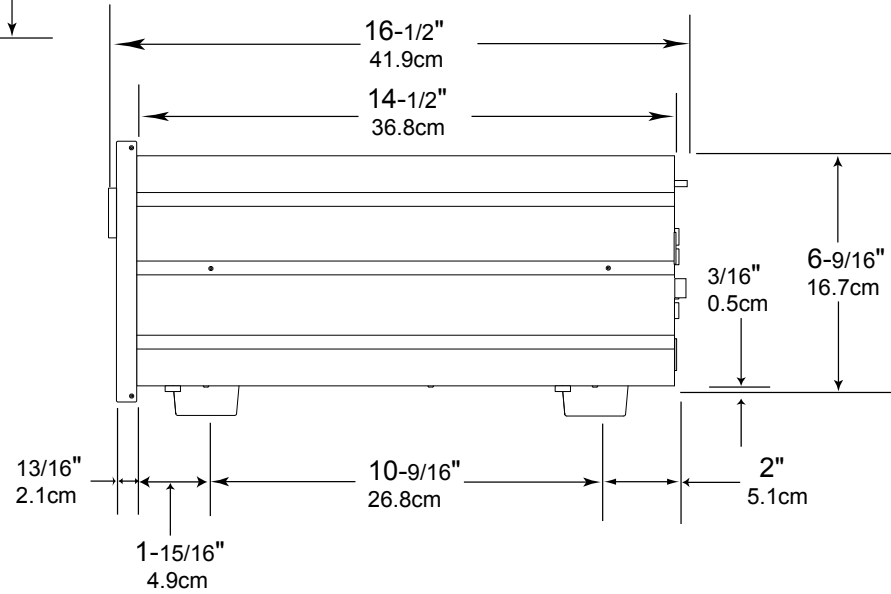

Rear View of the MX122

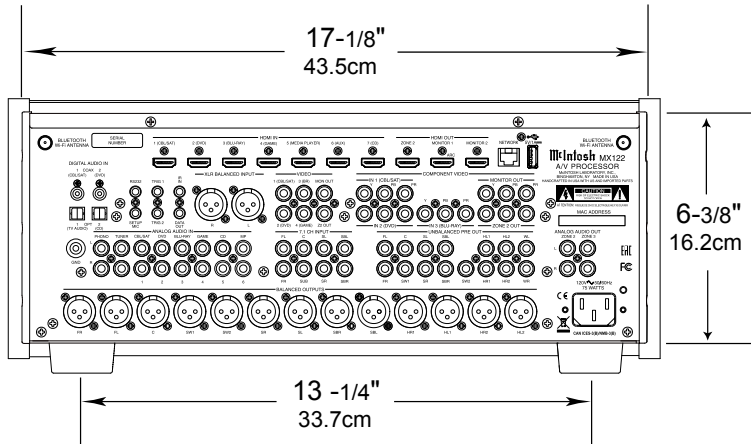

Installation

The MX122 can be placed upright on a table or shelf, standing on its four feet. It also can be custom installed in a piece of furniture or cabinet of your choice. The four feet may be removed from the bottom of the MX122 when it is custom installed as outlined below. The four feet together with the mounting screws should be retained for possible future use if the MX122 is removed from the custom installation and used free standing. The required panel cutout, ventilation cutout and unit dimensions are shown.

Always provide adequate ventilation for your MX122. Cool operation ensures the longest possible operating life for any electronic instrument. Do not install the MX122 directly above a heat generating component such as a high powered amplifier. If all the components are installed in a single cabinet, a quiet running ventilation fan can be a definite asset in maintaining all the system components at the coolest possible operating temperature.

When the MX122 is placed free-standing on a flat surface, allow at least 2 inches (5.08cm) above the top and 2 inches (5.08cm) on each side, so airflow is not obstructed. Allow 19-1/2 inches (49.53cm) depth behind the front panel. Allow 1-7/16 inch (3.66cm) in front of the mounting panel for knob clearance.

A custom cabinet installation should provide the minimum spacing dimensions for cool operation. Allow at least 2 inches (5.08cm) above the top, 2 inches (5.08cm) below the bottom and 2 inches (5.08cm) on each side, so airflow is not obstructed. The Custom Cabinet should be open backed and at least 12 inches (30.48cm) away from any surface such as a wall. Be sure to cut out a ventilation hole in the mounting shelf according to the dimensions in the drawing. Allow 1-7/16 inch (3.66cm) in front of the mounting panel for knob clearance.

**MX122 Front Panel
Custom Cabinet Cutout**

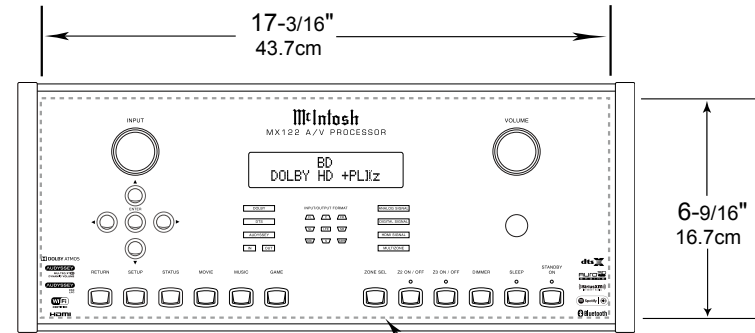

**MX122 Side View
in Custom Cabinet**

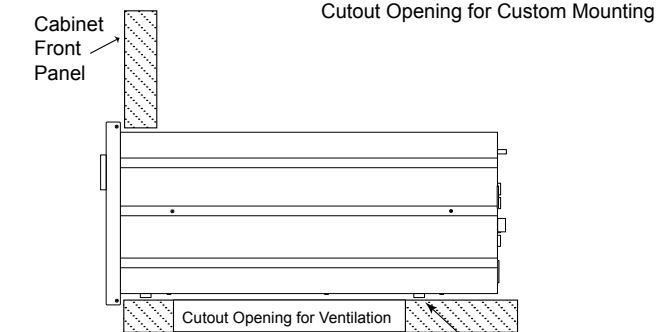

**MX122 Bottom View
in Custom Cabinet**

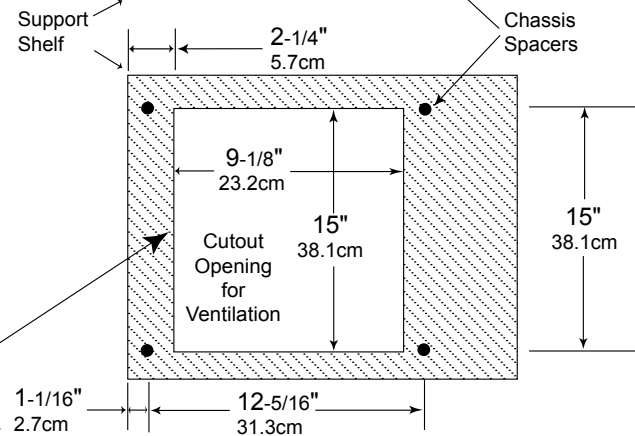

Note: Center the cutout horizontally on the unit. For purposes of clarity, the above illustration is not drawn to scale.



Rear Panel Connections

The identification of Rear Panel Connections for the MX122 A/V Processor is located on a separate folded sheet contained in the Owner’s Manual Packet. Refer to separate sheet “Mc1A” for the Rear Panel Connections.

MX122 A/V Processor Rear Panel

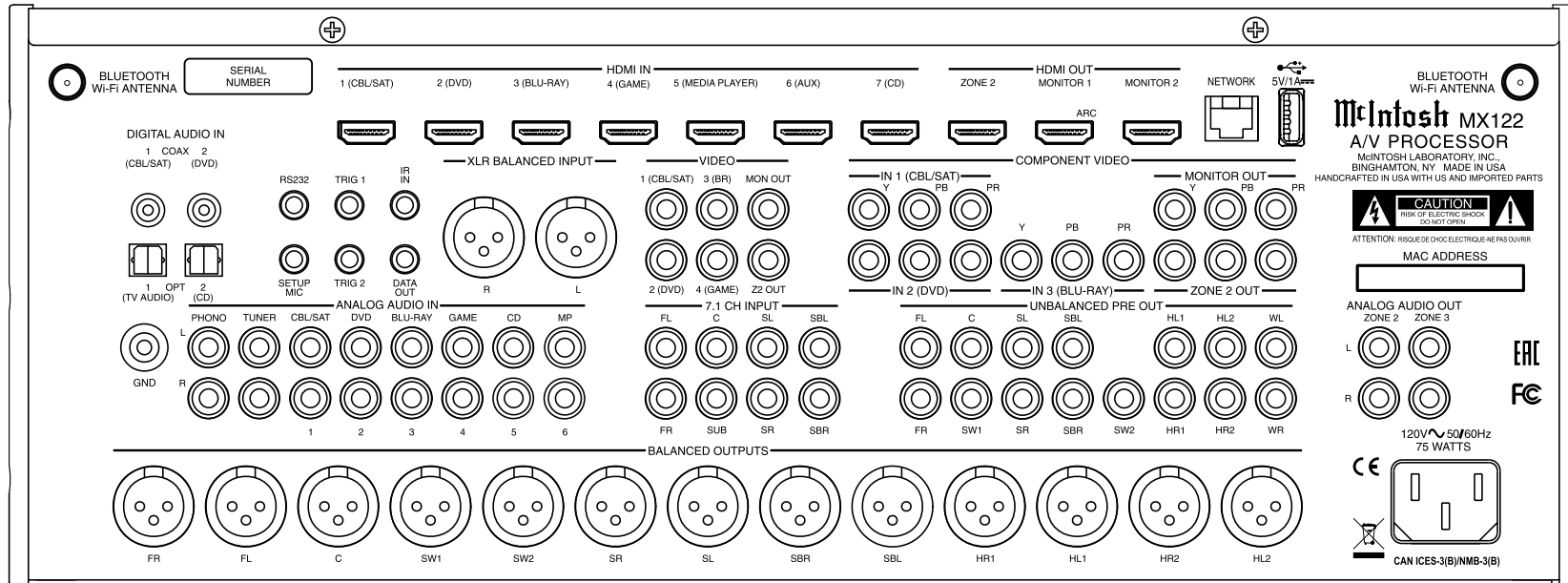

MX122 Main Zone Input Connections

The MX122 has the ability to automatically switch power On/Off to Source Components via the Trigger (Power Control) Connections. With an external sensor(s) connected, remote control operation of the system is possible.

The Main Zone connection instructions below, together with the MX122 Input Connection Diagram located on the separate folded sheet “**Mc2A**”, is an example of a typical Home Theater System. Your system may vary from this, however the actual components would be connected in a similar manner. For additional information refer to “Connector and Cable Information” on page 6.

Note: The following source component and sensor connections made to the MX122 are using the default settings. To make changes to the default settings proceed to Setup Mode starting on page 16.

Power Control Connections:

1. Connect a Control Cable from the MX122 TRIGGER (Power Control) 1 Jack to the Power Control Remote In on the Turntable.
2. Connect a Control Cable from the Turntable Power Control Remote Out Jack to the Streaming Audio Player Trigger In Jack.
3. Connect a Control Cable from the Streaming Audio Player Trigger Out Jack to the AM/FM Tuner Power Control In Jack.
4. Connect a Control Cable from the AM/FM Tuner Power Control Out Jack to the Audio/Video Disc Player Power Control In Jack.
5. Connect a Control Cable from the Audio/Video Disc Player Control Out Jack to the Media Server PWR CTRL (Power Control) In Jack.
6. Connect any additional McIntosh Components in a similar manner, as outlined in steps 1 thru 5.
7. Connect a Control Cable from the Media Server

PWR CTRL (Power Control) Out Jack to the Power Amplifier Main Zone Power Control In Jack.

Data Control Connections:

8. Connect a Control Cable from the MX122 DATA OUT Jack to one end of a Stereo 3.5mm "Y" adapter.
9. Connect a Control Cable from the AM/FM Tuner DATA IN Jack to another end of the Stereo 3.5mm "Y" adapter.
10. Connect a Control Cable from the Audio/Video Disc Player DATA IN Jack to the remaining end of the Stereo 3.5mm "Y" adapter.

IR In Connections:

11. Optionally, connect the Control Cable from the External IR Sensor to the MX122 IR IN Main Zone Jack.

Note: Refer to page 5 for information on compatible Sensors and page 6 for Cable/Connection information.

Analog Audio Connections:

12. Connect Balanced Cables from the MX122 XLR BALANCED INPUT connectors to the Media Server Audio Output Balanced connectors.
13. Connect Audio Cables from the MX122 PHONO Jacks to the Turntable Out Jacks.
14. Connect Audio Cables from the MX122 TUNER INPUT Jacks to the AM/FM Tuner UNBALANCED Output Jacks.

Digital Audio Connections:

15. Connect a Digital Coaxial Cable from the MX122 DIGITAL AUDIO IN COAX 2 (DVD) Optical Connector to the Streaming Audio Player Digital Coaxial Output Connector.

HDMI Connections:

16. Connect a HDMI Cable from the MX122 HDMI INPUT 1 (CBL/SAT) Connector to the Satellite Receiver HDMI Out Connector.
17. Connect a HDMI Cable from the MX122 HDMI INPUT 5 (MEDIA PLAYER) Connector to the Media Server HDMI Out Connector.
18. Connect a HDMI Cable from the MX122 HDMI INPUT 3 (BLU-RAY) Connector to the Audio/Video Disc Player HDMI Out Connector.

Ground Connections:

19. Connect a Ground Cable from the MX122 GND Binding Post to the Turntable GND Binding Post.

Computer/Network Connections:

20. Using a CAT 5/6 Ethernet Cable, connect the cable from the Network Router/Switch to the NETWORK connector on the Rear Panel of the MX122.

Note: If there is no Network Router/Switch available, a computer may be connected to the MX122 Network Connector by using an Ethernet Crossover cable/adaptor. Refer to “Connector and Cable Information” on page 6.

Proceed to Main Zone Output Connections on the next page.



MX122 Main Zone Output Connections

The MX122 has the ability to automatically switch power On/Off to the Power Amplifier via the Trigger (Power Control) Connections.

The connection instructions below, together with the MX122 Main Zone Output Connection Diagram located on the separate folded sheet “**Mc2B**”, is an example of a typical 5.1 thru 7.1 Channel Home Theater System using a Seven Channel Power Amplifier. The separate folded sheet “**Mc3A**” is an example of a typical 5.1.4 thru 7.1.4 Channel Home Theater System using two additional Power Amplifiers. Your system may vary from this, however the actual components would be connected in a similar manner. For additional information refer to “Connector and Cable Information” on page 6.

Note: The following component connections made to the MX122 are using the default settings. To make changes to the default settings proceed to Setup Mode starting on page 16.

5.1 THRU 7.1 CHANNEL CONNECTIONS:

Trigger (Power Control) Connections:

1. Connect a Control Cable from the Media Server Power Control OUT Jack to the Power Control In on the Main Zone Power Amplifier.
*Note: Refer to separate folded sheet “**Mc2A**” and page 11 step 7 for additional information.*
2. Connect a Control Cable from the Main Zone Power Amplifier Power Control Out to the Powered Subwoofer Power Control In Jack.
3. Connect any additional McIntosh Components in a similar manner, as outlined in steps 1 thru 2.
4. Connect a Control Cable from the Powered Subwoofer Power Control Out Jack to the Main Zone Power Amplifier Two Power Control In Jack (used in a 5.1.4 or 7.1.4 Channel System).

Analog Audio Connections:

5. Connect Balanced Audio Cables from the MX122 LF (Left Front Channel), C (Center Channel), RF (Right Front Channel), SL (Surround Left Channel), SR (Surround Right Channel) to the Main Zone Power Amplifier matching channels respectively.
6. Optional, connect Balanced Audio Cables from the MX122 LRS (Left Rear Surround Channel) and RRS (Right Rear Surround Channel) to the Main Zone Power Amplifier, matching channels respectively.
7. Connect a Balanced Audio Cable from the MX122 SW1 (Low Frequency Effects Channel, also referred to as a “Subwoofer Out”), to the Powered Subwoofer MONO Input.

HDMI Connections:

8. Connect a HDMI Cable from the MX122 HDMI OUTPUT 1 Connector to the Zone A TV/Monitor HDMI Input connector.

Notes: 1. When the system is either a 5.1 or 7.1 Channel Home Theater System, proceed to step 13. If the Home Theater System consists of 5.1.4 or 7.1.4 Channels, proceed to step 9.

2. When Zone B (Audio/Video in another room) on the MX122 will be utilized, proceed to page 14 for information on making the needed additional connections after all the Main Zone Power Amplifier connections are completed.

5.1.4 THRU 7.1.4 CHANNEL CONNECTIONS:

Power Control Connections:

9. Connect a Control Cable from the Powered Subwoofer Power Control Out Jack to the Power Control In on the Main Zone Power Amplifier Two.
10. Connect a Control Cable from the Main Zone A

Power Amplifier Two Power Control Out Jack to the Main Zone A Power Amplifier Three Power Control In Jack.

Analog Audio Connections:

11. Connect Balanced Audio Cables from the MX122 HR1 (Height Right 1 Front Channel) and HL1 (Height Left 1 Front Channel) to the Main Zone Power Amplifier Two Inputs Left and Right respectively.
12. Optional, connect Balanced Audio Cables from the MX122 HR2 (Height Right Rear Channel) and HL2 (Height Left Rear Channel) to the Main Zone Power Amplifier Three Inputs Left and Right respectively.

Proceed to Zone B Output Connections on the next page when MX122 Zone B will be utilized. If Zone B will not be used at this time perform step 13 below:

AC Power Cords Connections:

13. Connect the MX122 and any remaining components’ AC Power Cords to a live AC outlet.

MX122 Zone 2 Output Connections

The MX122 has the ability to automatically switch power On/Off to McIntosh Power Amplifiers via the Power Control/Trigger connections.

The following connection instructions, together with the MX122 Zone 2 Output Connection Diagram located on the separate folded sheet “**Mc3B**”, is an example of a typical Zone 2 Second Room System. Your system may vary from this, however the actual components would be connected in a similar manner. For additional information refer to “Connector and Cable Information” on page 6.

Note: The following component connections made to the MX122 are using the default settings.

Power Control Connections:

1. Connect a Control Cable from the MX122 TRIGGER (Power Control) 2 Jack to the Power Control In on Zone 2 Power Amplifier.

Note: To assign the TRIGGER 2 Output to activate when Zone 2 is selected requires changes to the default setting in the Setup Mode. Refer to page 25.

2. Connect any additional McIntosh Components in a similar manner, as outlined in step 1.

Analog Audio Connections:

3. Connect Audio Cables from the MX122 ANALOG AUDIO OUT Zone 2 OUT Jacks - L (Left Channel) and R (Right Channel) to Zone 2 Power Amplifier Left and Right respectively.

Analog Video Connections:

4. Connect a HDMI Cable from the MX122 HDMI OUT Zone 2 connector to the Zone 2 TV/Monitor HDMI Input Connector.

AC Power Cords Connections:

5. Connect the MX122 and any remaining components’ AC Power Cords to a live AC outlet.

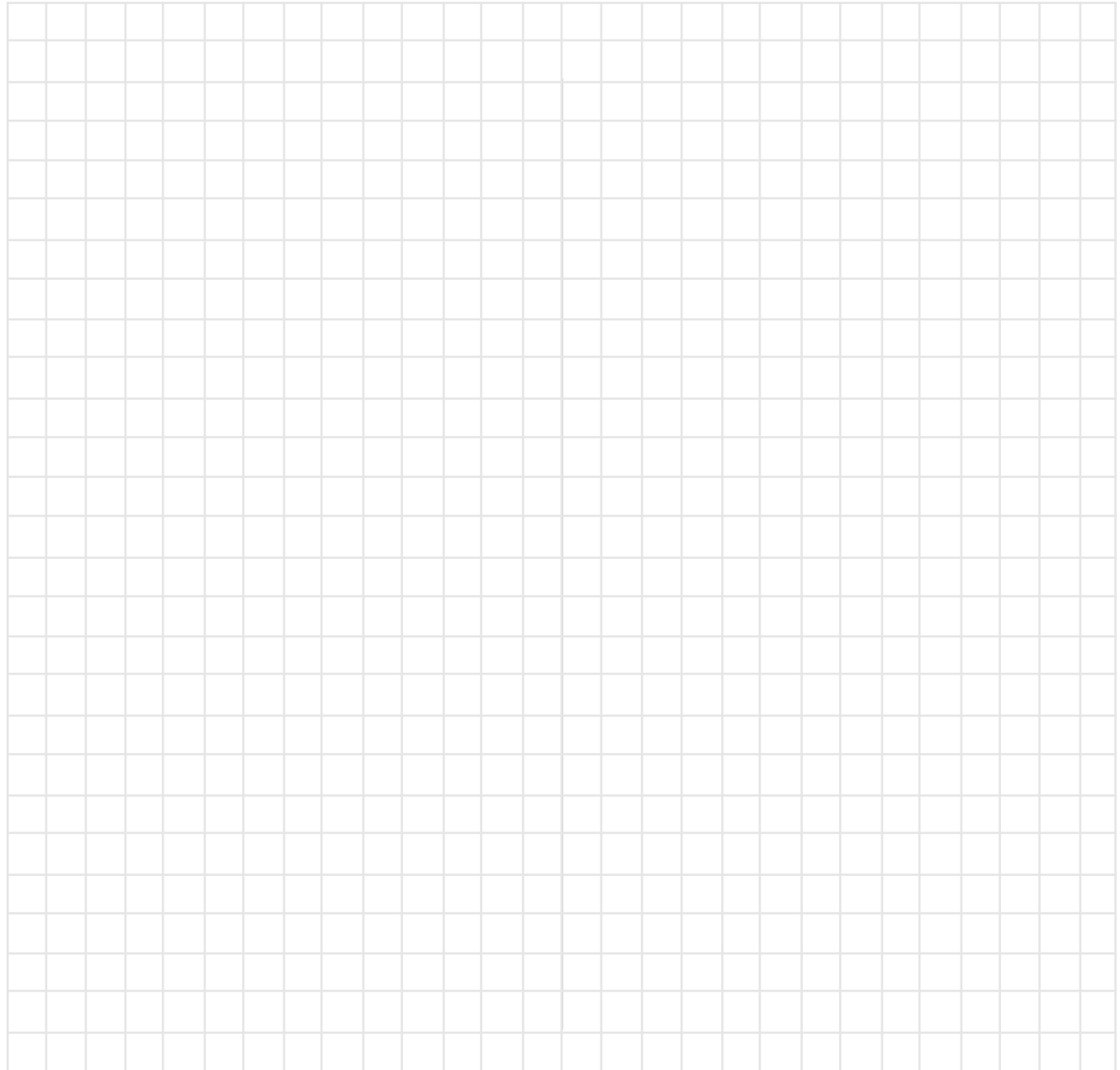



Front Panel Display, Controls, and Push-buttons

The identification of the MX122 A/V Processor Front Panel Display, Controls, and Push-buttons is located on a separate folded sheet contained in the Owner's Manual Packet. Refer to separate sheet "Mc1B".

MX122 A/V Processor Front Panel

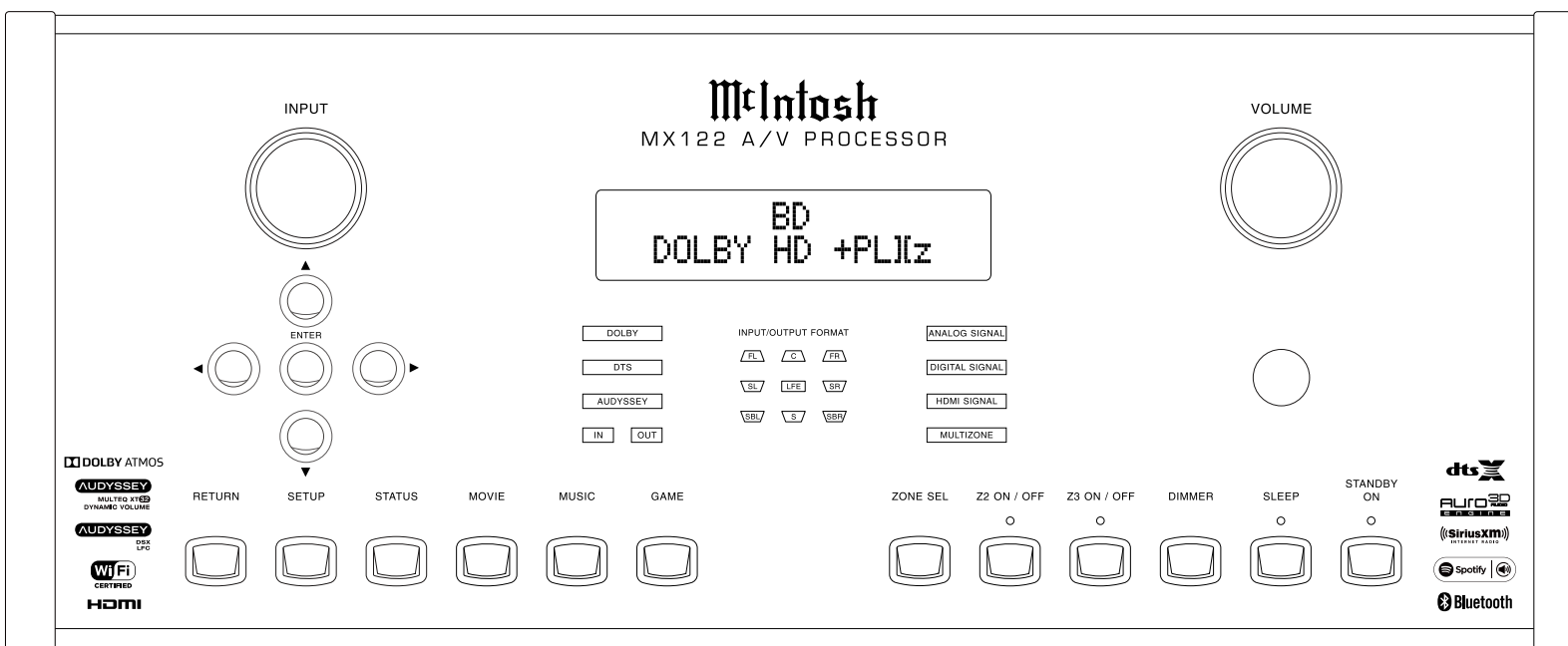

Remote Control Push-Buttons

The identification of Remote Control Push-Buttons for the MX122 A/V Processor is located on a separate folded sheet contained in the Owner's Manual Packet. Refer to separate sheet "Mc4A" for Push-button identification.

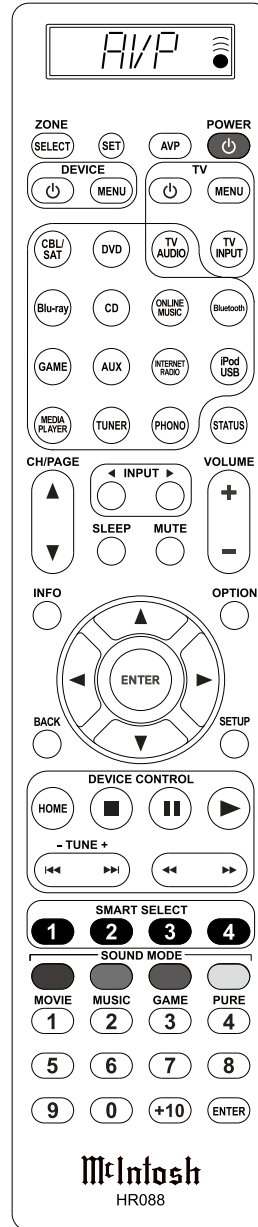



Introduction to the MX122 Setup Mode

Your McIntosh MX122 has been factory configured for default operating settings that will allow you to immediately enjoy superb video and high fidelity audio.

It is important to have first performed the MX122 Connections and Setup Settings changes as outlined in the MX122 Initial Setup Guide (Separate folded sheet). After performing the steps outlined in the Initial Setup Guide and if you wish to make additional changes to the factory default settings, perform the following steps. If not, proceed to “How to Operate the MX122” starting on page 34.

Power

The Red LED above the STANDBY/ON switch lights to indicate the MX122 is connected to AC Power. To Switch ON the MX122, press the STANDBY/ON Push-button on the Front Panel or the (Power) Push-button on

the Remote Control. The MX122 STANDBY Red LED will switch Off and the Front Panel illumination will switch On as part of the initialization process. Refer to figures 1 and 4.

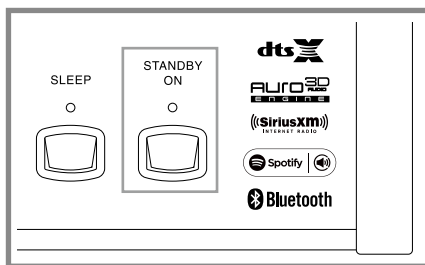

Figure 1

Note: When the MX122 is switched On, it will take about 15 seconds for initialization of the internal circuitry.

Adjustments and Setting changes

All of the adjustments and settings are performed by using the extensive On-Screen Setup Menu System. The On-Screen Setup Menuing System is interactive.

The ability to change a menu item setting or have access to a menu item setting, is dependent on the operational state of the MX122 and the choices made in other menu items. Some menu choices require more than one step to complete.

1. Press the AVP (Audio Video Processor) Remote Control Push-button, then press the SETUP Push-button to enter the Setup Mode. The Front Panel Information Display will indicate the Main Setup Menu. Refer to figures 2 and 3.



Figure 2

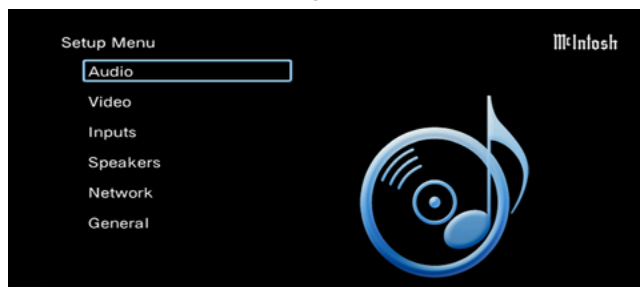

Figure 3

Note: While Setup adjustments can be accomplished using the MX122 Front Panel Information Display, the On-Screen Display on a Monitor/TV connected to the HDMI Monitor 1 or 2 Output allows more information to be visible at the same time, making it easier to navigate through the choices.

2. Navigating thru and making changes to the Setup Menus are performed by using the HR088 Remote Control directional Up▲ or Down▼, Left◀ or Right▶, ENTER and the SETUP Push-buttons. The MX122 Front Panel Navigation Up▲, Down ▼, Left◀, Right▶ and ENTER Push-buttons may also be used.

3. Access the desired Setup Menu by pressing the Up▲ or Down▼ Left◀ or Right▶ Directional Push-buttons. Pressing the ENTER Push-button will then activate the highlighted Menu Item.
4. Return to the Main Menu by pressing the BACK Push-button on the Remote Control.
5. To exit the SETUP Mode press the SETUP or BACK Push-button.

To assist in navigating the On Screen Menus, please refer to the set of MX122 Menu separate folded sheets "MX122-Menu-1 thru Menu-9".

These separate sheets are contained in the Owner's Manual Packet.

Checking the Network Connection

The following example will illustrate how to navigate through the built-in MX122 SETUP Mode and the multiple On-Screen Menus.

Occasionally, McIntosh might make available Firmware Update/Upgrade for the MX122. These Update/Upgrade would be from the McIntosh Computer Server via a Network Internet Connection. When the Firmware Notifications are set to ON (Setup Menu, General/Firmware/Notifications, figure 5) the MX122 will periodically scan for an update/upgrade.

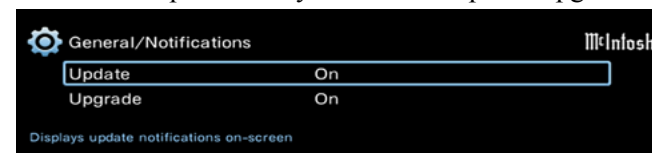

Figure 5

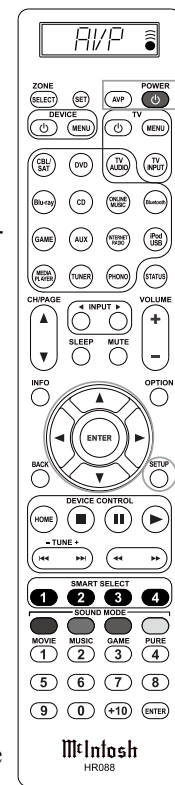

Figure 4

If an update/upgrade is available, the MX122 will display a message On-Screen and also on the Front Panel Information Display. For more information about the MX122 Network Connections refer to the separate folded sheet "MX122 Initial Setup Guide" and Network Setup pages 22 and 23.

With the MX122 connected to your Home Network via a Network Router with an active Internet Access Device connected, perform the following steps:

1. Press the SETUP Push-button on the Remote Control and the Main Setup Menu will appear on the Monitor/TV screen. Using the Down▼ Directional Push-button on the Remote Control select "General". Refer to figure 6.
3. Select "Firmware" by using the Down▼ Directional Push-button on the Remote Control. Refer to figure 7.
4. Referring to figure 8 press the ENTER Push-button on the Remote Control to select "Update".
5. Figure 9 will now appear on the screen, press the ENTER Push-button on the Remote Control. The MX122 will now connect to the Internet and check to see if a Firmware Update is available. Refer to figures 10 and 11.
6. Referring to figure 12, if it is desirable to switch Off the Automatic Firmware Notification, use Directional Up▲ or Down▼ Push-button on the Remote Control to select "Notification", followed by pressing the ENTER Push-button.
7. To switch Off the Firmware Update, first press the ENTER Push-Button, then use the Directional Left◀ or Right▶ Push-button to select "Off" followed by pressing the ENTER Push-button. Refer to figure 5.
8. To exit the SETUP Mode press the SETUP or BACK Push-button.

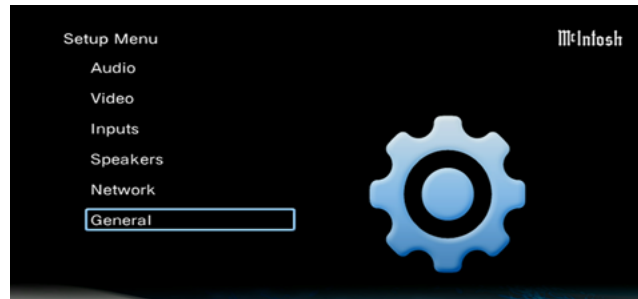

Figure 6



Figure 7

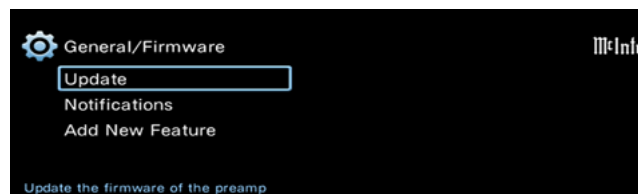

Figure 8

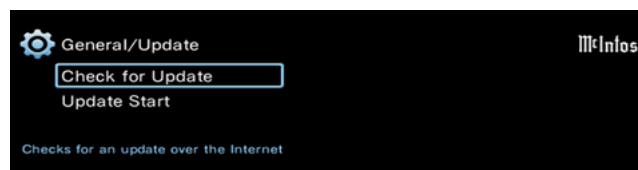

Figure 9

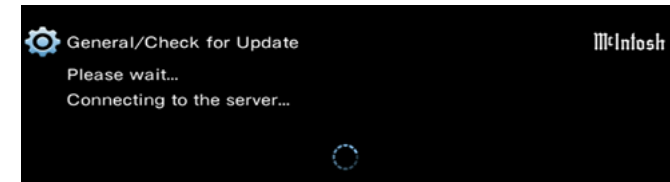

Figure 10

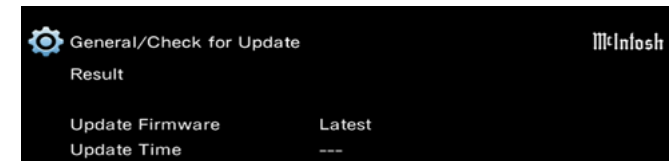

Figure 11

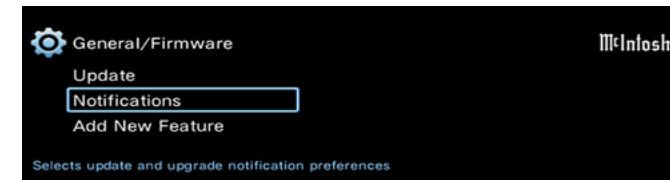

Figure 12

For the vast majority of MX122 Owners, the Default Settings and Suggested Component Connections are all one needs for full enjoyment of movies, still photos, videos and music.

The MX122 Setup Mode has a number of additional options allowing integration into your Home Theater System. Usually, your McIntosh Dealer and/or Custom Installer uses these additional capabilities.

The navigation and selection methods previously illustrated also apply to the remainder of Setup Mode Settings, which resume on page 18.

To begin enjoying the MX122 proceed to "How to Operate the MX122" starting on page 34.



AUDIO SETUP MENU

MENU ITEM	SUB MENU	SELECTION	OPTION(S)	DESCRIPTION
Subwoofer Level Adjust		●Off	On Subwoofer 1, On Subwoofer 2, ±12dB	Refer to the bottom of Video Screen for Information.
Bass Sync		●0ms	0-16ms	Refer to the bottom of Video Screen for Information.
Surround Parameter				
	Cinema EQ	●Off	On	Refer to the bottom of Video Screen for Information.
	Loudness Management	●On	Off	Refer to the bottom of Video Screen for Information.
	Dynamic Compression	●Auto	Off, Low, Medium, High	Refer to the bottom of Video Screen for Information.
	Low Frequency Effects	●0dB	0 to -10dB	Refer to the bottom of Video Screen for Information.
DFR		●Off	Low, Medium, High	Refer to the bottom of Video Screen for Information.
Audio Delay		●0ms	0ms to 200ms	Refer to the bottom of Video Screen for Information.
Volume				
	Scale	●0 - 98	-79.5dB - 18.0dB	Refer to the bottom of Video Screen for Information.
	Limit	●Off	60, 70, 80	Refer to the bottom of Video Screen for Information.
	Power On Level	●Last	Mute, 1 to 98	Refer to the bottom of Video Screen for Information.
	Mute Level	●Full	-40dB, -20dB	Refer to the bottom of Video Screen for Information.
Audyssey	<i>Note: All of the Audyssey Adjustments are grayed out, except for "Audyssey DSX" until the Audyssey Room Correction has been applied, refer to page 30.</i>			
	MultEQ XT32	●Reference	L/R Bypass, Flat, Off	Requires Audyssey Room Correction applied and Refer to the bottom of Video Screen for Information.
	Dynamic EQ	●On	Off	Requires Audyssey Room Correction applied and Refer to the bottom of Video Screen for Information.
	Dynamic EQ, -Reference Level Offset	●0dB	On	Requires Audyssey Room Correction applied and Refer to the bottom of Video Screen for Information.
	Dynamic Volume	●Off	Heavy, Medium, Light	Requires Audyssey Room Correction applied and Refer to the bottom of Video Screen for Information.
	Audyssey LFC	●Off	On	Requires Audyssey Room Correction applied and Refer to the bottom of Video Screen for Information.
	Audyssey LFC, - Containment Amount	●4	1, 2, 3, 5, 6, 7	Requires Audyssey Room Correction applied and Refer to the bottom of Video Screen for Information.
	Audyssey DSX	●Off	Wide, Height, Wides/Heights	Refer to the bottom of Video Screen for Information.
	Audyssey DSX, -Stage Width	●0	-10 to +10	Requires Audyssey Room Correction applied, Front Width Loudspeakers and Refer to the bottom of Video Screen for Information.

Notes: The ● indicates the default setting. When there are grayed out menu items appearing, other Setup Mode Options need to be activated first in order to make changes.

AUDIO SETUP MENU, con't				
MENU ITEM	SUB MENU	SELECTION	OPTION(S)	DESCRIPTION
	Audyssey DSX, -Stage Height	●0	-10 to +10	Requires Audyssey Room Correction applied, Front Height Loudspeakers and Refer to the bottom of Video Screen for Information.
Graphic EQ				
	Graphic EQ	●Off	On	Refer to the bottom of Video Screen for Information.
	Speaker Selection	●Left/Right	Each, All	Refer to Separate Sheet "Mc MX122 Menu-2" and the bottom of Video Screen for Information.
VIDEO SETUP MENU				
MENU ITEM	SUB MENU	SELECTION	OPTION(S)	DESCRIPTION
Picture Adjust		●Off	Standard, Movie, Vivid, Streaming, Custom	Refer to the bottom of Video Screen for Information.
Picture Adjust: Custom Mode				
	Contrast	●0	-50 to +50	For 1080P resolution, Refer to the bottom of Video Screen for Information.
	Brightness	●0	-50 to +50	For 1080P resolution, Refer to the bottom of Video Screen for Information.
	Saturation	●0	-50 to +50	For 1080P resolution, Refer to the bottom of Video Screen for Information.
	Noise Reduction	●Off	Low, Medium, High	For 1080P resolution, Refer to the bottom of Video Screen for Information.
	Enhancer	●0	0 to +12	For 1080P resolution, Refer to the bottom of Video Screen for Information.
HDMI Setup				
	Auto Lip Sync	●On	Off	Refer to the bottom of Video Screen for Information.
	HDMI Audio Out	●AVP	Off	Requires HDMI Control Off, Refer to the bottom of Video Screen for Information.
	Video Output	●Auto(Dual)	Monitor 1, Monitor 2	Refer to the bottom of Video Screen for Information.
	Vertical Stretch	●Off	On	Refer to the bottom of Video Screen for Information.
	HDMI Pass Through	●On	Off	Requires HDMI Control Off, Refer to the bottom of Video Screen for Information.
	HDMI Control	●Off	On	Refer to the bottom of Video Screen for Information.
	Pass Through Source	CBL/SAT	Select Desired Input Source	Refer to the bottom of Video Screen for Information.
	TV Audio Switching	●On	Off	Requires HDMI Control On, Refer to the bottom of Video Screen for Information.
	Power Off Control	●All	Video, Off	Requires HDMI Control On, Refer to the bottom of Video Screen for Information.
Output Settings				
	Video Mode	●Auto	Game, Movie	Refer to the bottom of Video Screen for Information.
	Video Conversion	●On	Off	Refer to the bottom of Video Screen for Information.

Notes: The ● indicates the default setting. When there are grayed out menu items appearing, other Setup Mode Options need to be activated first in order to make changes.



VIDEO SETUP MENU, con't

MENU ITEM	SUB MENU	SELECTION	OPTION(S)	DESCRIPTION
Output Settings, con't				
	i/p Scaler	●Analog	Off, Analog &HDMI	Refer to the bottom of Video Screen for Information.
	Resolution (analog)	●Auto	480p/576p, 1080i, 720p, 1080p 1080p:24Hz, 4K, 4K (60/50)	Requires i/p Scaler set to Analog or Analog HDMI, it will then convert the analog input signal to the selected Digital Output Signal Resolution. Refer to the bottom of Video Screen for Information.
	Resolution (HDMI)	●Auto	480p/576p, 1080i, 720p, 1080p 1080p:24Hz, 4K, 4K (60/50)	Requires i/p Scaler set to Analog HDMI, it will then convert the analog input signal to the selected Digital Output Signal Resolution. Refer to the bottom of Video Screen for Information.
	Progressive Mode	●Auto	Video, Video and Film	Refer to the bottom of Video Screen for Information.
	Aspect Ratio	●16:9	4:3	Refer to the bottom of Video Screen for Information.
Analog Video Out				
	Zone	●MAIN ZONE	ZONE3	Refer to the bottom of Video Screen for Information.
On Screen Display				
	Volume	●Bottom	Top, Off	Refer to the bottom of Video Screen for Information.
	Info	●On	Off	Refer to the bottom of Video Screen for Information.
	Now Playing	●Always On	Always Off	Refer to the bottom of Video Screen for Information.
TV Format	Format	●NTSC	PAL	Refer to the bottom of Video Screen for Information.

INPUTS SETUP MENU

MENU ITEM	SUB MENU	SELECTION	OPTION(S)	DESCRIPTION
Inputs				
	Input Assign	Refer to Separate Sheet "Mc MX122 Menu-4" and the Top Left Video Screen for the Default Input Assignment Information. All of the default Input Names have already been assigned to the various signal type connectors on the rear panel of the MX122. They include HDMI (Digital Video and Audio), Digital Audio (Coaxial and Optical), Analog Audio, Component Video (Analog Video Signals) and Composite Video (Analog Video Signals). In order to reassign a given Input Name to a different Input Connector Type, first disable the existing input connector type by switching it Off using the dash symbol (-). Then for the same Input Name, select a different Input Connector Type with nothing connected to it.		
	Source Renaming	Refer to Separate Sheet "Mc MX122 Menu-4" and the two "Rename" Video Screens. All of the default Input Names (match the Input Assign Names) have direct access Push-buttons located on the HR088 Remote Control. When an Input is renamed (like the AUX Input is renamed to CD2) access CD2 by pressing the AUX Push-button or use the ◀ INPUT ▶ Push-buttons to select AUX by watching either the Front Panel Information Display or the TV/Monitor on-Screen Display.		
	Hide Source	●Show	Hide	Refer to Separate Sheet "Mc MX122 Menu-4" and the Top Right Video Screen, Refer to the bottom of Video Screen for Information.

Notes: The ● indicates the default setting. When there are grayed out menu items appearing, other Setup Mode Options need to be activated first in order to make changes.

INPUTS SETUP MENU, con't				
MENU ITEM	SUB MENU	SELECTION	OPTION(S)	DESCRIPTION
Inputs, con't				
	Source Level - Analog Inputs	●0dB	-12dB to +12dB	Select the desired Input Source before changing the level, Refer to the bottom of Video Screen for Information.
	Source Level - Digital Inputs	●0dB	-12dB to +12dB	Select the desired Input Source before changing the level, Refer to the bottom of Video Screen for Information.
	Input Select - Input Mode	●Auto	HDMI, Analog, 7.1 CH IN	Select the desired Input Source before changing the setting. When an Input Name has multiple connections made to it, the MX122 will either Automatically select which connection or you can select which one in advance, Refer to the bottom of Video Screen for Information.
	Input Select - Decode Mode	●Auto	PCM, DTS, Auro-3D	Select the desired Input Source before changing the setting. When an Input Name has multiple connections made to it, the MX122 will either Automatically select which connection or you can select which one in advance, Refer to the bottom of Video Screen for Information.

SPEAKERS SETUP MENU				
MENU ITEM	SUB MENU	SELECTION	OPTION(S)	DESCRIPTION
Audyssey Setup		Audyssey provides measurement of loudspeakers performance, distance and room acoustics. It will then automatically correct, providing better room acoustic via active room equalization. Refer to Separate Sheets "Mc MX122 Menu-5". It is very important to perform the Amp Assignment before starting Audyssey. Refer to pages 29 thru 31 while performing the Audyssey Setup.		
	Amp Assign	Is used to tell the MX122 and Audyssey how many loudspeakers there are, their location in the room and their function, Refer to the bottom of Video Screen for Information.		
	Channel Select	For demo purposes, allows for Audyssey to skip some of the loudspeakers to reduce the required measurement time and adjustment, Refer to the bottom of Video Screen for Information.		
	Check Results	After Audyssey has performed room measurements and room corrections, it can display its measurement and correction results, Refer to the bottom of Video Screen for Information.		
	Restore	Will restore the Audyssey Corrections even if some manual setting changes were made after Audyssey Measurements and Corrections were performed, Refer to the bottom of Video Screen for Information.		
	Start	After the Amp Assignment has been performed, the MX122 is now ready to start the Audyssey Procedure. Please follow all the On-Screen Instruction to insure Audyssey will provide the best possible performance and operational features upon competition.		
Manual Adjustment		Refer to Separate Sheets "Mc MX122 Menu-6 and Menu-7" for assistance in performing Manual Loudspeaker Adjustments.		
	Amp Assign	●11.1ch	9.1ch (Bi-Amp), 9.1ch+Front B,	This selects the overall number of Pre-Amp Output Channels and the number of Floor and Height Loudspeakers, Refer to the bottom of Video Screen for Information.
	Speaker Config.	Front, Center, Surround and Back Surround all Small and 1 Subwoofer	Large, small or none	The Large listing refers to the Loudspeaker's capability for reproducing bass frequencies down to 35Hz within -3dB of the midrange frequencies. If a Loudspeaker can not reproduce bass frequencies down to 35Hz within -3dB of the midrange frequencies, it is considered Small. Refer to the bottom of Video Screen for Information.

Notes: The ● indicates the default setting. When there are grayed out menu items appearing, other Setup Mode Options need to be activated first in order to make changes.



SPEAKERS SETUP MENU, con't

MENU ITEM	SUB MENU	SELECTION	OPTION(S)	DESCRIPTION
Manual Adjustment, con't				
	Distances	●12ft and 10ft	1ft to 60ft	Loudspeaker distances from the Main Listening/Viewing Area, Refer to the bottom of Video Screen for Information.
	Levels	●0dB	-12dB to +12dB	Select "Test Tone Start" and adjust so each loudspeaker is at the same volume level as heard in the Main Listening/Viewing Area, Refer to the bottom of Video Screen for Information.
	Crossovers	●All	Individual	Allows for the crossover point for the Loudspeakers to be set from 40Hz to 250Hz and they can be set the same or set individually, Refer to the bottom of Video Screen for Information.
	Bass	●LFE ●LPF (80Hz)	LFE+Main Low Pass Filter, 80Hz to 250Hz	By default any Speaker Configured as "Small" in Setup, will have any low frequency signal passed on to the Subwoofer and any Loudspeakers Configured as large. The LPF (Low Pass Filter) settings determine at what frequency it occurs. Refer to the bottom of Video Screen for Information.
	Front Loudspeakers	●A	B, A+B	Selects whether there is a single pair of Front Loudspeakers or two pairs of Front Loudspeakers. Refer to the bottom of Video Screen for Information.
	2ch Playback	●Auto	Manual	When the Speaker Adjustments were performed in the Manual Mode, the MX122 allows the "2ch Playback" changes to become active when the audio mode is set to STEREO during playback. Refer to the bottom of Video Screen for Information.

NETWORK SETUP MENU

MENU ITEM	SUB MENU	SELECTION	OPTION(S)	DESCRIPTION
Information				
	Friendly Name	●McIntosh:[MX122]	Refer to other Network Setup Functions to make changes	Refer to the bottom of Video Screen for Information.
	Connection	●Wired or Wireless	Refer to other Network Setup Functions to make changes	Refer to the bottom of Video Screen for Information.
	DHCP	●On	Refer to other Network Setup Functions to make changes	Refer to the bottom of Video Screen for Information.
	IP Address	-----	Determined by the Network Router or manually set in the "Network Setting" menu options	Refer to the bottom of Video Screen for Information.
	MAC Address	----- -	Is unique for each MX122 and is fixed by a Universal Standard.	Refer to the bottom of Video Screen for Information.

Notes: The ● indicates the default setting. When there are grayed out menu items appearing, other Setup Mode Options need to be activated first in order to make changes.

NETWORK SETUP MENU Con't				
MENU ITEM	SUB MENU	SELECTION	OPTION(S)	DESCRIPTION
Connection		●Wired or Wireless	Wired (Ethernet), Wireless (Wi-Fi)	If the MX122 is already setup for a Wired ((Ethernet) operation and Wireless (Wi-Fi) is selected remove the Wired Ethernet Cable from the rear panel of the MX122 before proceeding. When the MX122 is setup for Wireless operation and it is to be switched over to Wired ((Ethernet) operation, then connect the Wired Ethernet Cable to the rear panel of the MX122 before proceeding. Refer to the Video Screen for additional Information.
Settings				
	DHCP	●On	Off	DHCP is an automatic network process making all the necessary network settings for the MX122. If DHCP Off is selected, the following information will need to be entered manually: - IP Address, - Subnet Mask, - Default Gateway, - Primary and - Secondard DNS, Refer to the bottom of Video Screen for Information.
	Proxy	●Off	On(Address), On(Name)	When the MX122 is connected to a Proxy Server, select On and then enter the following: - Address and - Port, Refer to the bottom of Video Screen for Information.
IP Control		●Always On	Off in Standby	Refer to the bottom of Video Screen for Information.
Friendly Name		McIntosh:[MX122]	Home Theater, Living Room, Family Room, Guest Room, Kitchen, Dining Room, Master Bedroom, Bedroom, Den, Of- fice, Other	Refer to the bottom of Video Screen for Information.
Diagnostics				Refer to Video Screen for status of the Physical Connection, Router Access and Internet Access
GENERAL SETUP MENU				
MENU ITEM	SUB MENU	SELECTION	OPTION(S)	DESCRIPTION
Language		●English	Francais, Espanol	Refer to the bottom of Video Screen for Information.
ZONE2 Setup				
	Bass	●0dB	-10dB to +10dB	Refer to the bottom of Video Screen for Information.
	Treble	●0dB	-10dB to +10dB	Refer to the bottom of Video Screen for Information.
	High Pass Filter	●Off	On	Refer to the bottom of Video Screen for Information.
	Lch Level	●0dB	-12dB to +12dB	Refer to the bottom of Video Screen for Information.
	Rch level	●0dB	-12dB to +12dB	Refer to the bottom of Video Screen for Information.
	Channel	●Stereo	Mono	Refer to the bottom of Video Screen for Information.
	HDMI Audio	●Through	PCM	Refer to the bottom of Video Screen for Information.
	Volume Level	●Variable	1 to 98	Refer to the bottom of Video Screen for Information.
	Volume Limit	●70	80, Off, 60	Refer to the bottom of Video Screen for Information.

Notes: The ● indicates the default setting. When there are grayed out menu items appearing, other Setup Mode Options need to be activated first in order to make changes.



GENERAL SETUP MENU, con't

MENU ITEM	SUB MENU	SELECTION	OPTION(S)	DESCRIPTION
ZONE2 Setup, con't				
	Power On Volume	●Last	Mute, 1 to 70	Refer to the bottom of Video Screen for Information.
	Mute Level	●Full	-40dB, -20dB	Refer to the bottom of Video Screen for Information.
ZONE3 Setup				
	Bass	●0dB	-10dB to +10dB	Refer to the bottom of Video Screen for Information.
	Treble	●0dB	-10dB to +10dB	Refer to the bottom of Video Screen for Information.
	High Pass Filter	●Off	On	Refer to the bottom of Video Screen for Information.
	Lch Level	●0dB	-12dB to +12dB	Refer to the bottom of Video Screen for Information.
	Rch level	●0dB	-12dB to +12dB	Refer to the bottom of Video Screen for Information.
	Channel	●Stereo	Mono	Refer to the bottom of Video Screen for Information.
	Volume Level	●Variable	1 to 98	Refer to the bottom of Video Screen for Information.
	Volume Limit	●70	80, Off, 60	Refer to the bottom of Video Screen for Information.
	Power On Volume	●Last	Mute, 1 to 70	Refer to the bottom of Video Screen for Information.
	Mute Level	●Full	-40dB, -20dB	Refer to the bottom of Video Screen for Information.
Zone Rename				
	MAIN ZONE	●MAIN ZONE	Refer to Separate Sheet "Mc MX122 Menu-9" and the "General Zone Rename" Video Screen. Refer to the bottom of Video Screen for Information..	
	ZONE2	●ZONE2		
	ZONE3	●ZONE3		
Quick Select Names				
	Quick Select 1	●CBL/SAT	Uses the four "QUICK SELECT" Push-buttons on the Remote Control to display on the screen a custom name that was entered. Refer to Separate Sheet "Mc MX122 Menu-9" and Refer to the bottom of Video Screen for Information..	
	Quick Select 2	●Blu-ray		
	Quick Select 3	●Media Player		
	Quick Select 4	●Online Music		
Trigger Out 1				
	MAIN ZONE	●On	---	Refer to the bottom of Video Screen for Information.
	ZONE2	●On	---	Refer to the bottom of Video Screen for Information.
	ZONE3	●On	---	Refer to the bottom of Video Screen for Information.
	CBL/SAT	●On	---	Refer to the bottom of Video Screen for Information.
	DVD	●On	---	Refer to the bottom of Video Screen for Information.
	Blu-ray	●On	---	Refer to the bottom of Video Screen for Information.
	Game	●On	---	Refer to the bottom of Video Screen for Information.
	Media Player	●On	---	Refer to the bottom of Video Screen for Information.

Notes: The ● indicates the default setting. When there are grayed out menu items appearing, other Setup Mode Options need to be activated first in order to make changes.

GENERAL SETUP MENU, con't				
MENU ITEM	SUB MENU	SELECTION	OPTION(S)	DESCRIPTION
Trigger Out 1 con't				
	TV Audio	●On	---	Refer to the bottom of Video Screen for Information.
	AUX	●On	---	Refer to the bottom of Video Screen for Information.
	CD	●On	---	Refer to the bottom of Video Screen for Information.
	Phono	●On	---	Refer to the bottom of Video Screen for Information.
	Online Music	●On	---	Refer to the bottom of Video Screen for Information.
	iPod/USB	●On	---	Refer to the bottom of Video Screen for Information.
	Bluetooth	●On	---	Refer to the bottom of Video Screen for Information.
	Tuner	●On	---	Refer to the bottom of Video Screen for Information.
	HDMI Monitor 1	---	●On	Refer to the bottom of Video Screen for Information.
	HDMI Monitor 2	---	●On	Refer to the bottom of Video Screen for Information.
Trigger Out 2				
	MAIN ZONE	●On	---	Refer to the bottom of Video Screen for Information.
	ZONE2	●On	---	Refer to the bottom of Video Screen for Information.
	ZONE3	●On	---	Refer to the bottom of Video Screen for Information.
	CBL/SAT	●On	---	Refer to the bottom of Video Screen for Information.
	DVD	●On	---	Refer to the bottom of Video Screen for Information.
	Blu-ray	●On	---	Refer to the bottom of Video Screen for Information.
	Game	●On	---	Refer to the bottom of Video Screen for Information.
	Media Player	●On	---	Refer to the bottom of Video Screen for Information.
	TV Audio	●On	---	Refer to the bottom of Video Screen for Information.
	AUX	●On	---	Refer to the bottom of Video Screen for Information.
	CD	●On	---	Refer to the bottom of Video Screen for Information.
	Phono	●On	---	Refer to the bottom of Video Screen for Information.
	Online Music	●On	---	Refer to the bottom of Video Screen for Information.
	iPod/USB	●On	---	Refer to the bottom of Video Screen for Information.
	Bluetooth	●On	---	Refer to the bottom of Video Screen for Information.
	Tuner	●On	---	Refer to the bottom of Video Screen for Information.
	HDMI Monitor 1	---	●On	Refer to the bottom of Video Screen for Information.
	HDMI Monitor 2	---	●On	Refer to the bottom of Video Screen for Information.

Notes: The ● indicates the default setting. When there are grayed out menu items appearing, other Setup Mode Options need to be activated first in order to make changes.



GENERAL SETUP MENU, con't

MENU ITEM	SUB MENU	SELECTION	OPTION(S)	DESCRIPTION
Auto Standby				
	MAIN ZONE	●Off	15 min, 30 min, 60 min	Refer to the bottom of Video Screen for Information.
	ZONE2	●Off	2 hours, 4 hours, 8 hours	Refer to the bottom of Video Screen for Information.
	ZONE3	●Off	2 hours, 4 hours, 8 hours	Refer to the bottom of Video Screen for Information.
Front Display				
	Dimmer	●Bright	Dim, Dark, Off	Refer to the bottom of Video Screen for Information.
	Channel Indicators	●Output	Input	Refer to the bottom of Video Screen for Information.
Information				
	Audio	Indicates current Sound Mode, Input Signal Type, Sample Rate, Channel Format, Offset, Refer to the bottom of Video Screen for Information.		
	Video	HDMI Signal info. (Resolution, Color Space and Pixel Depth); HDMI Monitor 1 (Interface and available resolutions); HDMI Monitor 2 (Interface and available resolutions), Refer to the bottom of Video Screen for Information.		
	ZONE	MAIN ZONE (Select Source, Name, Sound Mode, Input Mode and Decode Mode; Type and Number of Connections (HDMI, Digital, Analog, Component Video and Composite Video); Video Mode, Content Type, Video Conversation, i/p Scaler); Refer to the bottom of Video Screen for Information. ZONE2 (Power, Select Source and Volume Level); Refer to the bottom of Video Screen for Information. ZONE3 (Power, Select Source and Volume Level); Refer to the bottom of Video Screen for Information.		
	Firmware	MX122 Main Version, -DTS Version; Refer to the bottom of Video Screen for Information.		
	Notifications	Notification Alerts default mode is On; Refer to the bottom of Video Screen for Information.		
Firmware				
	Update	Check for Update. Update Start (When an Update is available).		
	Notifications	Select (On or Off) whether Update is Displayed On Screen, Refer to the bottom of Video Screen for Information. Select (On or Off) whether Upgrade is Displayed On Screen, Refer to the bottom of Video Screen for Information.		
	Add a new Feature	Select whether to add a new Feature when they may become available, Refer to the bottom of Video Screen for Information.		
Setup Lock		●Off	On	Can prevent access to the MX122 Setup Menu, Refer to the bottom of Video Screen for Information.

Notes: The ● indicates the default setting. When there are grayed out menu items appearing, other Setup Mode Options need to be activated first in order to make changes.

IR Sensor Setting

The MX122 has a Front Panel IR Sensor along with provisions for connecting an external sensor. With both sensors in the same room, possible interference can occur between the signals. To prevent possible operational problems it maybe necessary to disable the MX122 Front Panel Sensor. Perform the following steps to disable the sensor:

1. With the MX122 in STANDBY MODE press and hold down the Front Panel ENTER and RETURN Push-buttons while pressing the STANDBY/ON Push-button. When the MX122 Front Panel Nomenclature is illuminained, release the three Push-buttons. The MX122 Front Panel Information Display will now indicate the current status of the Front Panel/Volume Control. Refer to figures S1 and S2.

*Note: On the Front Panel Display the asterisk symbol * ahead of the words On and Off indicates the active status of the Front panel, Volume Control or the IR Sensor.*

2. Press the Down Directional Push-button and the



Figure S2

Front Panel Information Display will now indicated the second menu option (the Front Panel is not LOCKed Off). Refer to figure S3.

3. Press the Down Directional Push-button three



Figure S3

more times. Figures S4, S5 will momentarily appear, followed by the desired menu option to switch Off the Front Panel IR Sensor. Refer to figure S6.



Figure S4



Figure S5



Figure S6

4. Press the Front Panel Up Push-button to select disabling the Front Panel IR Sensor. Refer to figure S7.



Figure S7

5. Then press the ENTER Push-button to activate the change. The MX122 will now switch power Off to activate the change.

To re-activate the MX122 Front Panel Sensor perform steps 1 through 3, in step four select "RC LOCK *Off" followed by the ENTER Push-button.

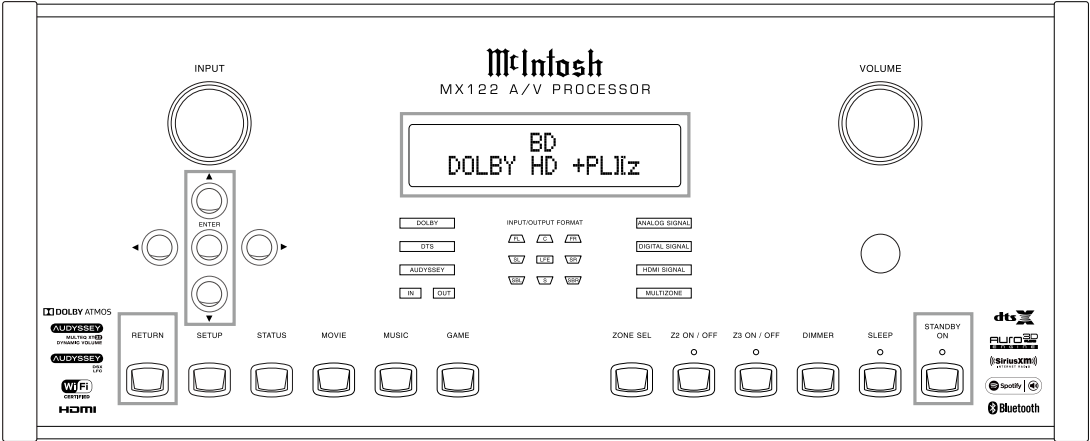

Figure S1

Initial Loudspeaker Setup

Before proceeding with Audyssey Auto Setup, it is very important to first go into the Setup Mode to establish the correct settings for your specific Loudspeaker complement and location in the Home Theater Room. This will not only assure the best acoustic performance using Audyssey Room Equalization Correction, but it will also assure the best sonic performance using the latest in surround sound technology built into the MX122. Please refer to the MX122 Menu separate folded sheets "MX122-Menu-5" while performing the following steps:

1. If the Remote Control LCD Display does not indicate "AVP", press the AVP Push-button. Refer to figure 16.
2. Press the SETUP Push-button to enter the Setup Mode.
3. Using the Navigation Push-buttons and the Enter Push-button on the Remote Control or Front Panel, select from the On-Screen menu "Speakers" followed by "Amp Assign". Refer to the MX122 Menu - 5 Separate Sheet.
4. The default setting for Loudspeakers is 11.1 Loudspeakers. Refer to figure 14.



Figure 14

5. If your Home Theater Room is different, please change it by using the "Floor- Layout" and/or "Height" Setting. Refer to figure 15.



Figure 15

6. Those settings can be changed by using the the Remote Control or Front Panel directional Up▲ or Down▼, Left◀ or Right▶, ENTER and the SETUP Push-buttons. First highlight the "Floor - Layout", then press the ENTER Push-button followed by using the Left◀ or Right▶ directional Push-buttons to select the correct number of "Floor Located" Loudspeakers, followed by the Height Sp, Dolby Sp and/or Layout.
7. When completed proceed to Audyssey Setup.

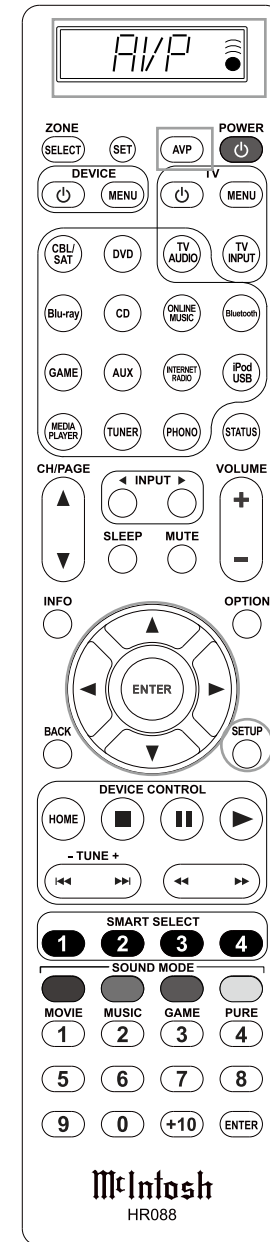

Figure 16

Audyssey® Auto Setup Information

The acoustic characteristics of the connected speakers and listening room are measured and the optimum settings are made automatically.

Assemble the supplied setup microphone and stand, then place it in the main listening position. Refer to figure 17. Keep the following things in mind during the Audyssey procedure:

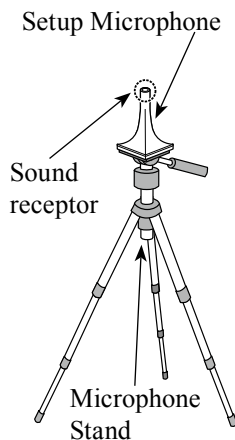

Figure 17

1. When placing the setup microphone, adjust the height of the sound receptor to the level of the listener's ear.
2. When performing Audyssey Setup, MultEQ® XT32 Audyssey Dynamic EQ®/ Audyssey Dynamic Volume® functions become active.
3. Make the room as quiet as possible. Background noise can disrupt the room measurements. Close windows, silence cell phones, televisions, radios, air conditioners, fluorescent lights, home appliances, light dimmers, or other devices as measurements may be affected by these sounds.
4. Cell phones should be placed away from all audio electronics during the measurement process as Radio Frequency Interference (RFI) may cause measurement disruptions (even if the cell phone is not in use).
5. Do not unplug the setup microphone from the main unit until Audyssey Setup is completed.
6. Do not stand between the speakers and setup microphone or allow obstacles in the path while the measurements are being made. This will cause inaccurate readings.
7. Loud test sounds may be played during Audyssey setup. This is part of normal operation. If there is background noise in the room, these test signals will increase in volume.

8. Do not adjust Volume during the measurements as this will cancel the measurements.
9. Do not hold the setup microphone in your hand during measurements.
10. Avoid placing the setup microphone close to a seat back or wall as sound reflections may give inaccurate results.

Measurements will be performed by placing the setup microphone successively at multiple positions throughout the entire listening area. For best results, we recommend you measure in six or more positions, as shown in the illustration (up to eight positions) about the main listening position (*M). Refer to figure 18A.

The main listening position is the position where listeners would normally sit or where one would normally sit alone within the listening environment.

The ideal Loudspeaker

Placement in a room for the best sonic effect is in the Side View Illustration. Refer to figure 18B. Both the Front Height and Rear Height Loudspeakers should be pointed slightly downward. Before starting Audyssey Setup, place the setup microphone in the main listening position. Audyssey MultEQ® XT32 uses the measurements from this position to calculate speaker distance, level, polarity, and the optimum crossover value.

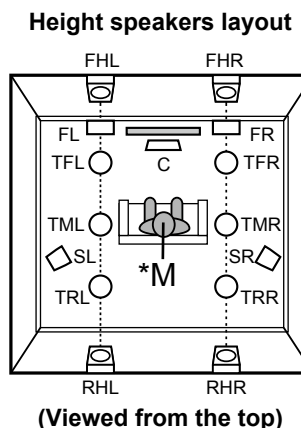

(Viewed from the top)

Figure 18A

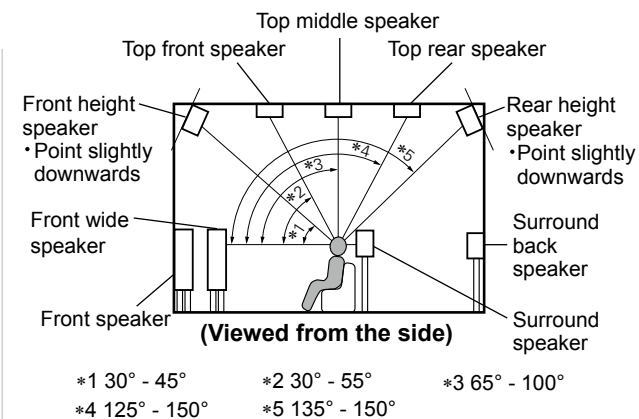

Figure 18B

When using a Powered Subwoofer(s) adjust the controls on the Subwoofer for neutral settings, as Audyssey will be making the adjustments of volume, crossover frequency, etc. Refer to the Subwoofer Owners Manual for additional information.

Proceed to "Audyssey Setup Procedure" on the next page.

Audyssey® Auto Setup Procedure

With the MX122 connected to a TV/Monitor, the supplied microphone connected to the SETUP MIC Jack on the Rear Panel and placed in the "Main Listening Location", perform the following steps along with the instructions appearing On-Screen:

1. Press the AVP Push-button, then press the SETUP Push-button.
2. Using the Remote Control Directional Push-buttons first select "Speakers" followed by "Audyssey Setup". Refer to figure 19.



Figure 19

3. Select "Start", then press Enter.
4. Follow the instructions on the screen display and press "Next" to proceed further.
5. When the following screen is displayed, select "Begin Test" and then press Enter. Start the mea-



Figure 20

surement of the first position. Refer to figure 20.

6. A test tone will be sent to all channels, one at a time to identify the channels making up your system.

*Notes: 1. Depending on the number of channels in your system, the illustrations in this Owner's Manual might differ from the actual On-Screen Graphics.
2. During the setup process On-Screen error messages may appear, if they do refer to page 32 for assistance.*

7. When the detected speakers are displayed, select "Next" and then press Enter. This will start the Measurement Process. A special audio test signal will be sent to all previously detected channels, one at a time. Refer to figure 21.



Figure 21

Audyssey Setup will take measurements from eight different locations in the room to achieve the best possible sonic results. The additional measurement locations are indicated by the small Balloons in the room illustration, placed around the sitting area and the Main sitting position is indicated by number "1".

8. Following the On-Screen instructions, place the microphone in the 2nd listening position and then press the ENTER Push-Button on the Remote

Control to select highlight on-screen button "Continue". Refer to figure 22.

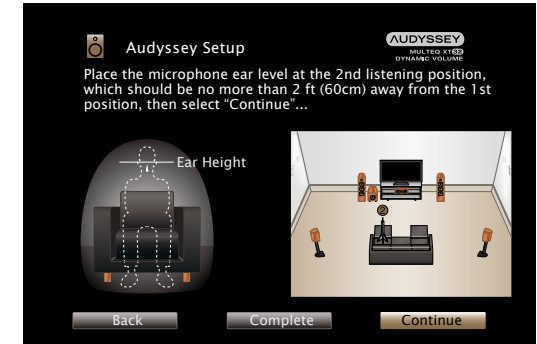

Figure 22

9. Continue following the On-Screen instructions and repeat the measurement process until all eight listening positions have been measured. The On-Screen message will now indicate the measurements are finished. Refer to figure 23.

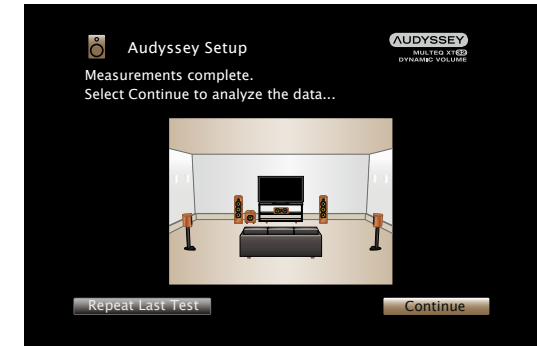

Figure 23

Note: Measurement of 3 listening positions are required to enable MultEQ® XT32.

10. Select "Continue", then press Enter.
11. Perform the settings for Audyssey Dynamic EQ® and Audyssey Dynamic Volume®.

The following screen is displayed during the analysis. Refer to figure 24.

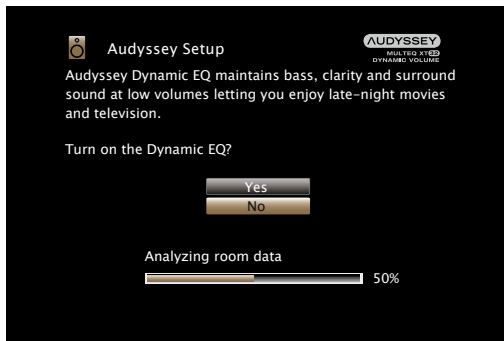

Figure 24

Configure the settings as preferred.

- Dynamic EQ corrects the frequency response in consideration of the audio characteristics of the room and human hearing ability so that sound can be heard even at low volume. This is recommended when using the unit with the volume turned down, e.g. when enjoying a movie or TV program in the middle of the night.
 - Dynamic Volume adjusts the output volume to the optimal level while constantly monitoring the level of the audio input to the unit. Optimal volume control is performed automatically without any loss in the dynamism and clarity of the sound when, for example, the volume suddenly increases for commercials shown during television programs.
12. When the analysis and storage ends, unplug the Sound Calibration Microphone from the SETUP MIC Jack on the Rear Panel and press Next. Refer to figure 25.

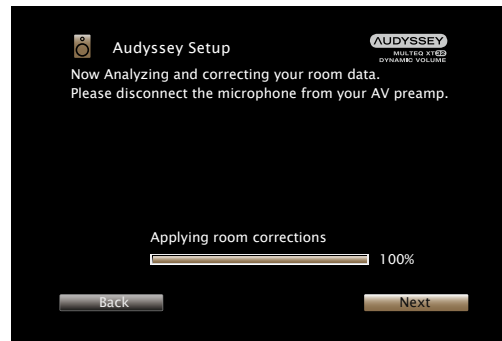
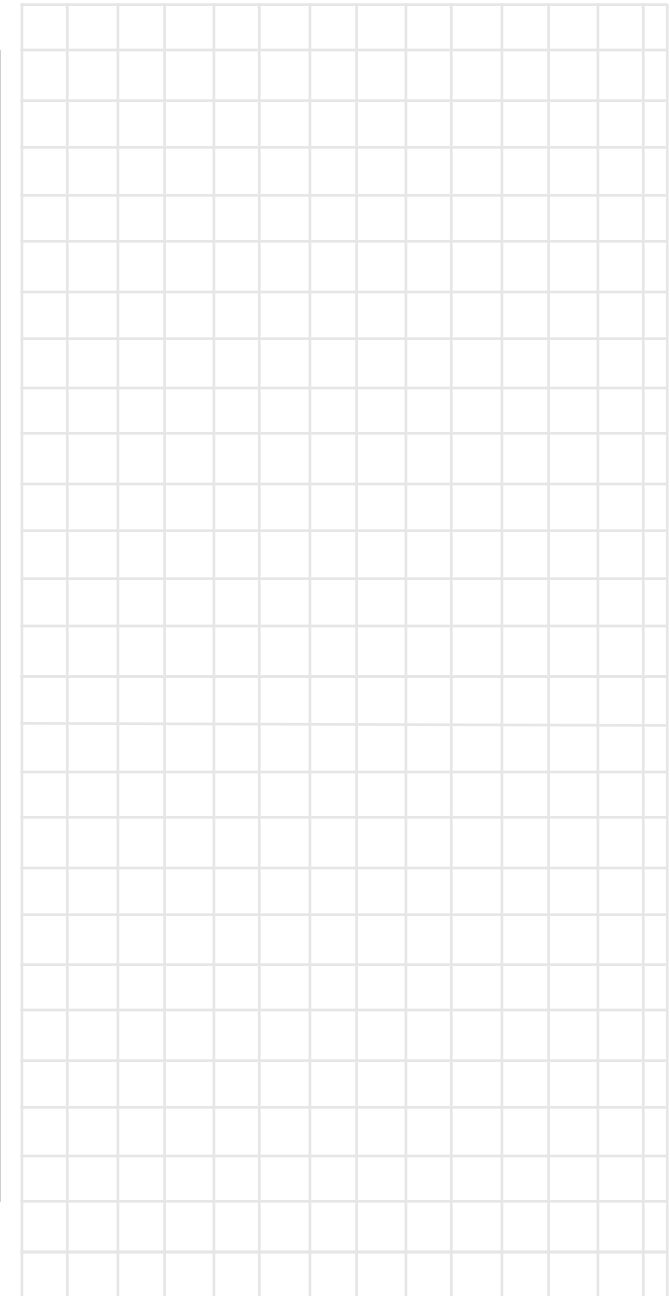

Figure 25

13. Select "Details" and press Enter to verify the measurement results.
- Subwoofers may measure a greater reported distance than the actual distance due to added electrical delay common in subwoofers.
Note: Do not change the speaker connections or subwoofer volume after Audyssey® Setup. If these are changed, run Audyssey® Setup again in order to configure the optimum equalizer settings.



Audyssey® Error Messages

An error message is displayed if Audyssey® Setup could not be completed due to speaker placement, the measurement environment, etc. If an error message is displayed, check the relevant items and perform the necessary measures. Be sure to turn off the power before checking speaker connections.

Subwoofer level error message and how to adjust

The optimal level of each subwoofer channel for Audyssey® Setup measurement is 75dB. During subwoofer level measurement, an error message is displayed when one level of subwoofer is outside the 72-78dB range. Refer to figure 26.

Error message

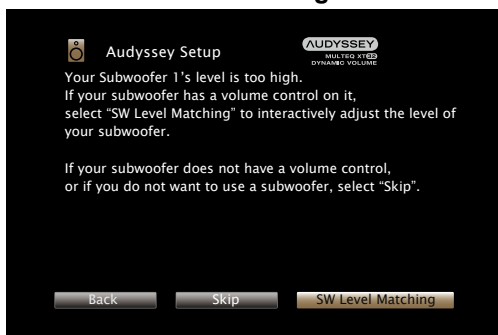

Figure 26

When using a subwoofer with built-in amplifier (active type), adjust the subwoofer volume so the subwoofer level is within the 72-78 dB range.

Retrieving Audyssey® Setup settings

If you set "Restore..." to "Restore", you can return to Audyssey® Setup measurement result (value calculated at the start by MultEQ® XT32) even when you have changed each setting manually. Refer to figure 27.

Examples	Error Details	Corrective Measures
No Speakers found	Sound calibration microphone is not detected. Not all speakers could be detected.	Connect the included Sound Calibration Microphone to the SETUP MIC jack on the Rear Panel. Check the speaker connections.
Ambient noise is too high or level is too low.	There is too much noise in the room. Speaker or subwoofer sound is too low.	Either turn off any device generating noise or move it away. Perform again when the surroundings are quieter. Check the speaker installation and the direction in which the speakers are facing. Adjust the subwoofer's volume.
Front R: None	The displayed speaker could not be detected.	Check the connections of the displayed speaker.
Front R: Phase	The displayed speaker is connected with the polarities reversed.	Check the polarity of the displayed speaker. For some speakers, this error message may be displayed even if the speaker is properly connected. If you are sure the connection is correct, press ► to select "Ignore", then press ENTER.

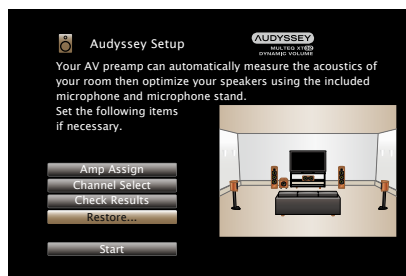
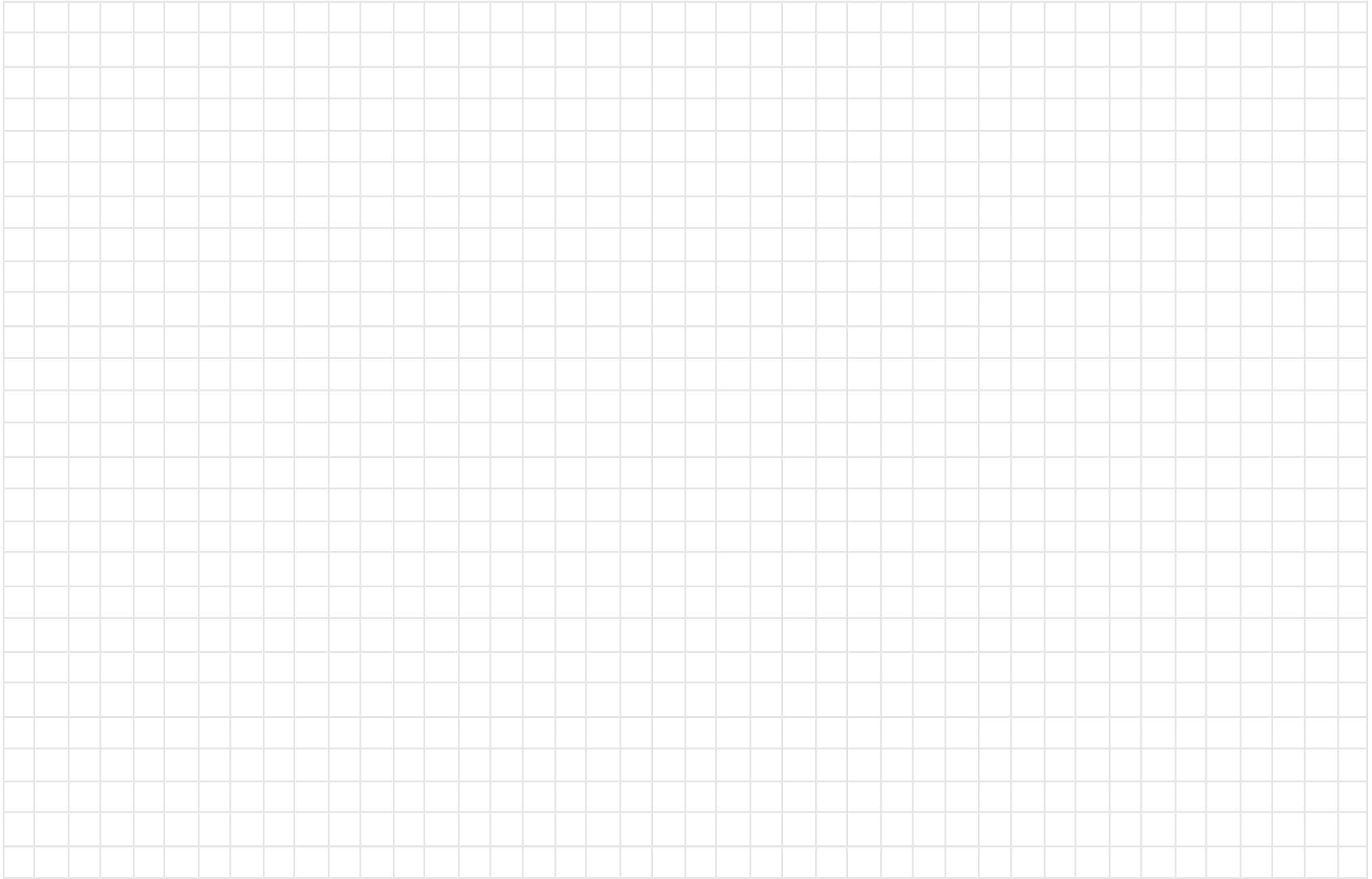

Figure 27





How to Operate the MX122

The McIntosh MX122 has been factory configured for default operating settings, allowing for immediate enjoyment of superb video and high fidelity audio without the need for further adjustments. If you wish to make changes to the factory default settings, refer to the SETUP Section of this Owner's Manual starting on page 16.

Notes: 1. It is advisable to perform "Audyssey Auto Setup" starting on page 29, to ensure the best audio performance.

2. In order for some of the Remote Control Push-Button Commands to be implemented by the MX122, such as activating the SETUP Menu Function, the LCD Display on the Remote Control needs to indicate "AVP". If the LCD Display does not indicate "AVP", press the "AVP" Push-button first before pressing the SETUP Push-button.

Power On and Off

Press the STANDBY ON Push-button on the Front Panel or press the ON Push-button on the Remote Control. The LED located above the STANDBY Push-button indicates when the MX122 is connected to AC Power. When the Initialization process is over, the display will indicate the last source selected and the volume level.

Notes: 1. The first time the MX122 is switched On the A/V Processor will go through an Initial Setup Process. Please refer to the separate supplied sheet "MX122 Initial Setup Guide" and follow the instructions.

2. If the MX122 A/V Processor is not going to be used for an extended period of time, please remove the AC Power Cord from the AC Outlet.

Input Selection

The INPUT Control selects the desired source and is indicated on the top line of the Front Panel Information Display. Refer to figure 20. The selection of the sources may also be accomplished by pressing the appropriate push-button on the Remote Control. Refer to figure 23. Using the MX122 INPUT Control, any one of the Inputs (CD, Tuner, DVD, Blu-ray, etc.) may be selected along with one Multichannel Analog Input. The Remote Control has twelve dedicated direct access push-buttons along with ▲ INPUT ▼ Push-buttons.

Note: To access the 7.1 Analog Multichannel Input Connection, assign it to a specific Input. Refer to Inputs Setup Menu, "Input Select- Input Mode" on page 21.

Volume Control and Muting

Adjust the VOLUME Control to select the desired listening level. The Volume Control adjusts all channels simultaneously. The Volume Level is indicated from 0.0 to 98% on the Front Panel Information Display and on the TV/Monitor Screen. The Remote Control may also be used to adjust the listening level by using the VOLUME +/- Push-button.

During the time VOLUME Control is rotated or the Remote Control VOL+/- Push-button is depressed, an On-Screen Display Overlay will appear showing the Volume Level. When the MUTE Push-button is pressed, the Front Panel Information Display will indicate "MUTING On". Pressing the MUTE Push-button a second time, the Display will indicate "MUTING Off" and the listening volume level will be restored.

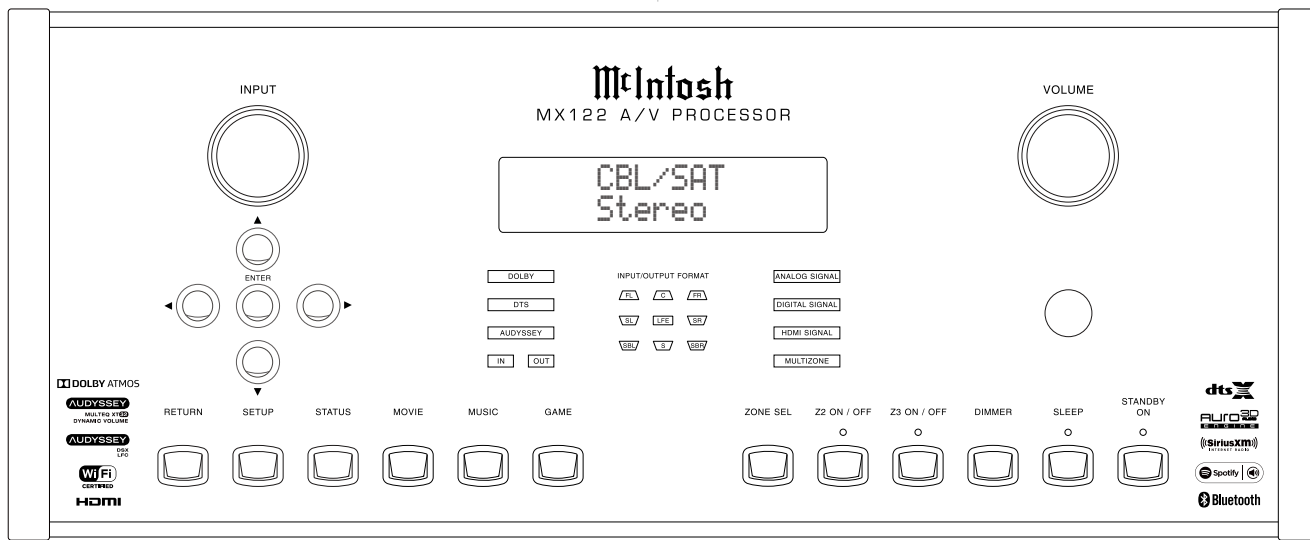

Figure 20

Front Panel Status

The three sets of Front Panel LEDs indicate the status of Input/Output Format, Operating Modes and Decoding Modes.

Note: If a Digital Input is selected and the Digital Source Component is not producing an output signal, none of the Front Panel Status LEDs will illuminate.

Input Format:

A. If the input signal source is Eight Channel, the front panel INPUT FORMAT LEDs FL, C, FR, SR, SBR, SBL, SL and LFE will illuminate.

Refer to figure 21.

Note: The Front Panel INPUT/OUTPUT FORMAT Display indicates either the INPUT Signal Channel Format or the OUTPUT Signal Channel Format.

The "IN" or "OUT" LEDs, located under the "AUDYSSEY" LED, indicate what Format Mode

is currently, being displayed. To change the Display Mode, refer to "General Setup Menu, Front Display Channel Indicators" on page 26.

B. If a Digital Input Signal Source is 2 Channel Surround Encoded, the front panel INPUT FORMAT LEDs FL, FR and S will illuminate.

Note: The "S" indicator will only illuminate on some surround encoded program material.

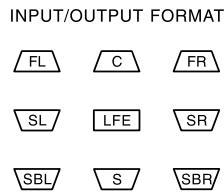

Figure 21

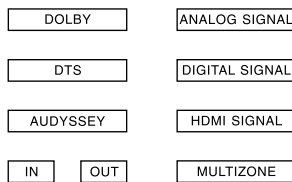

Figure 22

- C. If the Analog Input Signal Source is Stereo, the INPUT FORMAT LEDs FL and FR will illuminate.
- D. If an Analog Input Signal Source is Mono, both channels will be receiving the mono signal and the INPUT FORMAT LEDs FL and FR will illuminate.

Operating Mode Displays:

Refer to Figure 22 for the following:

- E. The DOLBY Display will illuminate when the Selected Input contains a Dolby Digital Signal.
- F. The DTS Display will illuminate when the Selected Input contains a DTS Digital Signal.
- G. The AUDYSSEY Display will illuminate when Audyssey Room Correction Circuitry is Active.
- H. The IN or OUT Display illuminates to indicate which mode the Channel Input/ Output Format is Displaying (Figure 21).
- I. The ANALOG SIGNAL Display will illuminate when the audio input signal is analog. Refer to figure 22.
- J. The DIGITAL SIGNAL Display will illuminate when the audio input signal is Digital.
- K. The HDMI SIGNAL Display will illuminate when the selected HDMI Connector is receiving a digital input signal.
- L. The MULTIZONE Display will illuminate when ZONE 2 and/or ZONE 3 are Active.

Output Format and Signal Processing:

The MX122 has two Signal Front Panel Displays. The Output Format LED Display indicates the Output Channels with Audio Signals Present, up to 7.1 Channels. Refer to figure 21. The Front Panel Information Display offers additional information about the mode of signal processing for the incoming signal.

- M. Stereo Input two channel mode will cause the FL and FR LEDs to illuminate.
- N. Dolby True HD 5.1 and DTS HD 5.1 Master Modes will cause the FL, C, FR, SR, SL and LFE to illuminate.
- O. Dolby True HD 7.1 and DTS HD 7.1 Master Modes will cause the FL, C, FR, SR, SBR, SBL, SL and LFE to illuminate.

Below are some examples of the Front Panel Information Displays indicating various Signal Processing Modes for incoming signals. Press the STATUS Push-button several times to display various information about the Input Signal and Signal Processing.

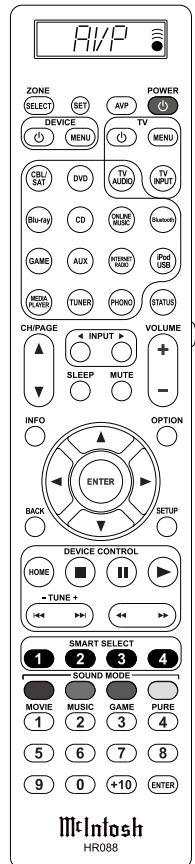
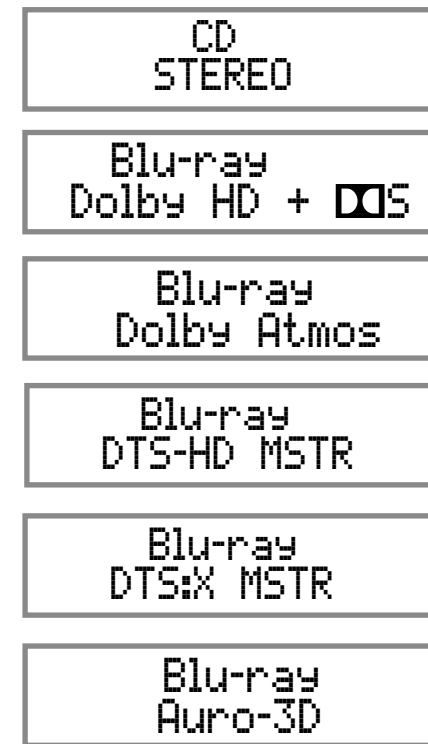

Figure 23



How to Operate the MX122, con't

Setup

Pressing the SETUP Push-button activates the MX122 SETUP Mode for making changes to the System settings. Once in the Setup Mode, press the SETUP Push-button to exit Setup Mode. Refer to the set of MX122 Menu separate folded sheets "MX122-Menu-1 thru Menu-9". These separate sheets are contained in the Owner's Manual Packet.

Return

When the MX122 is in Setup Mode it is used for returning to a previous Menu Screen.

Enter

When the MX122 is in the Setup Mode, press the ENTER Push-button on the Front Panel or on the Remote Control to select the highlighted option.

Navigate

Use the Directions Push-buttons ◀ (Left) and ▶ (Right) ▼ (Down) and ▲ (Up) on the Front Panel or

Remote Control to move Left, Right, Down or Up through Menu Options.

Status

Repeated presses of the Front Panel or Remote Control STATUS Push-button will step through the type of incoming Audio Signal, the selected Input (along with type of A/V Connection) and audio processing mode.

Movie

Pressing the Front Panel MOVIE Push-button will activate an On-Screen Menu allowing the selection of the desired Sound Processing Mode from a list. Refer to figure 24.

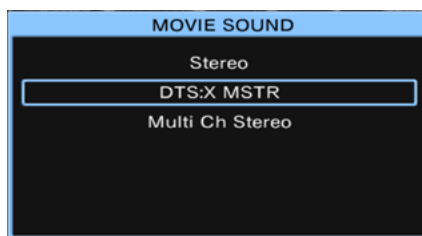

Figure 24

Music

Press the Front Panel MUSIC Push-button to activate an On-Screen Menu allowing the selection of the desired Sound Processing Mode from a list. Refer to figure 25.

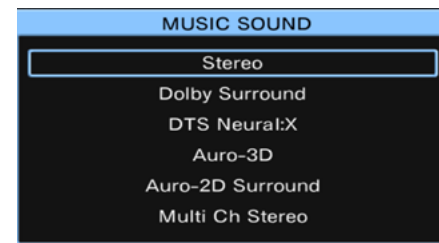

Figure 25

Game

Pressing the Front Panel GAME Push-button will activate an On-Screen Menu allowing the selection of the desired Sound Processing Mode from the menu list. Refer to figure 26.

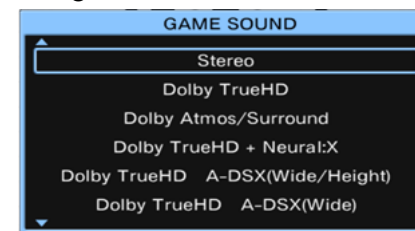

Figure 26

Zone Select

With Zone 2 and/or Zone 3 On, the MX122 Front Panel Input Control, Volume Control and Information Display can be used temporarily to control the selected Zone.

Zone 2

Press the Z2 ON/OFF Push-button to switch Zone 2 On or Off.

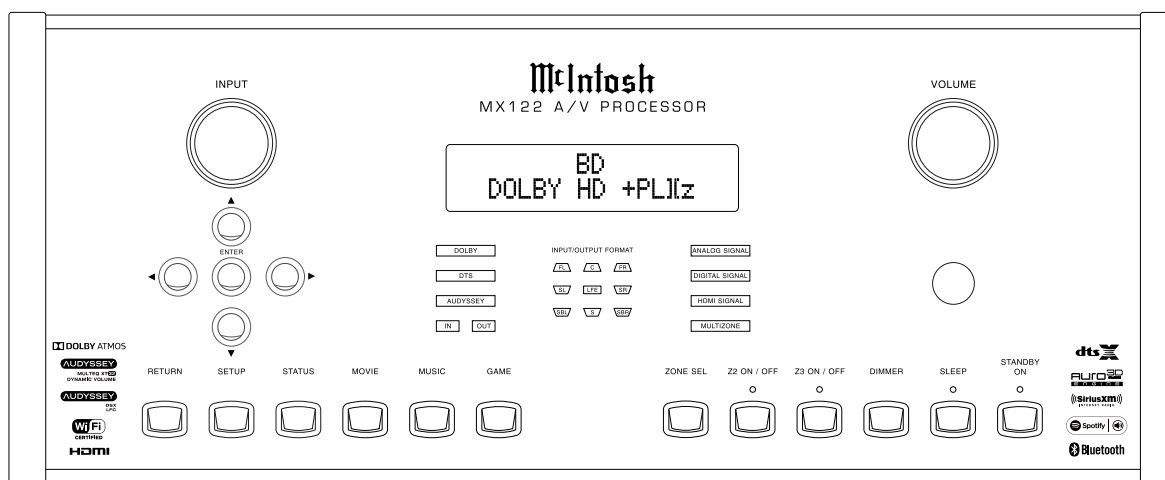

Figure 20

Zone 3

Press the Z3 ON/OFF Push-button to switch Zone 3 On or Off.

Remote Control Zone Operation

Using the Remote Control press the ZONE SELECT Push-button and the Remote Control LCD Display will indicate "MAIN"; press the Push-button again for "ZONE2". Then press the POWER push-button to activate Zone 2. Use the INPUT ▼ (Down) and ▲ (Up) Push-buttons to select the desired listening/viewing source. To switch OFF Zone 2 press the ZONE SELECT Push-button to select "ZONE2" followed by pressing the POWER Push-button.

Note: The operation of Zone 3 is similar to Zone 2, except Zone 3 is Audio only.

Dimmer

Repeated pressing of the Front Panel Dimmer Push-button will reduce the brightness of the Front Panel Information Display. There are two additional reduced brightness settings and the ability to switch the display Off.

Sleep

Press the SLEEP Push-button repeatedly to step through the Sleep Settings in increments of 10 minutes up to a maximum of 120 minutes, at which time the MX122 will switch Off.

Pure Direct

Press the PURE Push-button on the Remote Control to bypass the internal processing circuitry when not needed. An example could be when the analog audio output from a CD Player is connected to the

MX122 and the CD player is playing a stereo CD disc. The settings include AUTO (default setting, the MX122 chooses the best signal processing), DIRECT (bypasses Back Surround and Front Height Channel processing) and PURE DIRECT (bypasses all digital processing).

Note: When switching between the three modes, the sound is momentarily muted.

iPod® Playback

Connect the iPod to the MX122 Rear Panel iPod/USB Connector using the cable supplied with the iPod/iPhone. To playback music from the iPod through the MX122 perform the following steps:

1. Press the iPod/USB Push-button on the Remote Control. Refer to figure 23 on page 35.
2. Press the OPTION Push-button, select "iPod Browse Mode" from the On-Screen "Option" Menu and then press the ENTER Push-Button. Refer to figure 27.
3. Referring to figure 28, select "On-Screen" and then press the ENTER Push-Button.
4. Select from the On-Screen iPod List, one of the available choices. Refer to figure 29.

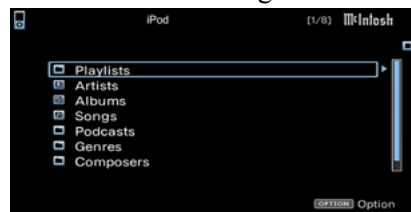

Figure 29

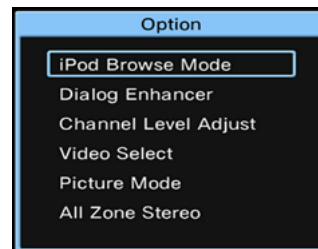

Figure 27

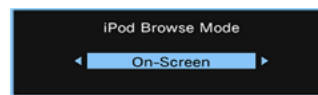

Figure 28

5. The menu item selected in step 4 was "Playlists", now select from the various "Playlists" Menu Items. Refer to figure 30.

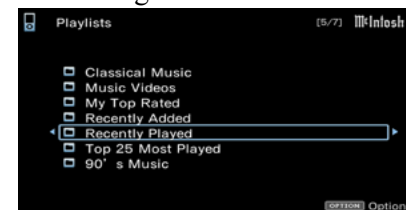

Figure 30

6. The iPod is now playing the selected music. Refer to figure 31. The icons listed at the bottom of the On-Screen indicate how to Pause Playback, Select Next or Previous, etc. using the MX122 Remote Control Direction Push-buttons.

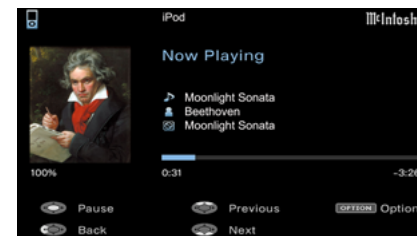

Figure 31

7. By pressing the "Option" Push-button on the Remote Control, the "Option menu" will appear On-Screen providing additional playback choices. Refer to figure 32.

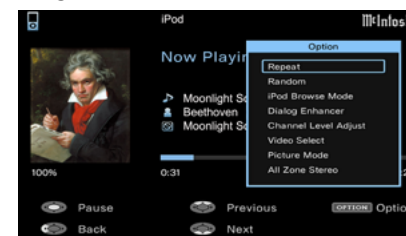

Figure 32



AirPlay®

Before proceeding, download and install the latest version of iTunes (version 10 or later) on the computer connected to the same network as the MX122. Also update your iPhone, iPod touch or iPad to the latest of the OS version for your specific device, for streaming capabilities.

Use the Apple Remote App for iPhone, iPod touch and iPad to control iTunes from any room in your home. The app is available as a free download from the App Store.

1. Switch On the MX122.
2. Activate the SETUP Mode and set “Network Standby” to ON. Refer to pages 22 and 23 along with separate folded sheet “MX122-Menu-8”.
3. Launch iTunes and click the AirPlay icon displayed in the upper left of the window and then select the MX122 from the list to allow the streaming music from the computer iTunes program to the MX122. Refer to figures 33 and 34.

AirPlay icon

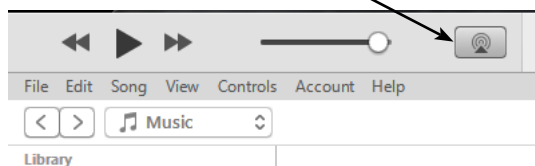

Figure 33

Select MX122

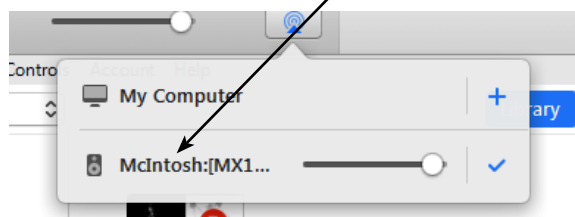

Figure 34

4. Choose a song and click Play in iTunes. The music will stream to the MX122. Refer to figure 35.

Select a Song

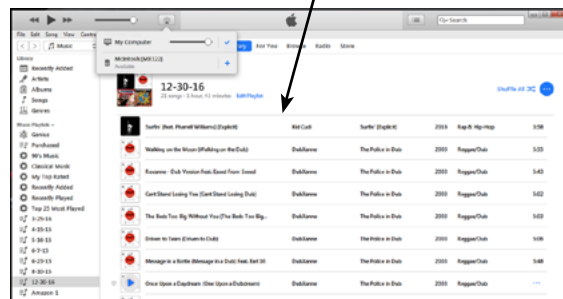

Figure 35

Streaming music from iPhone, iPod touch or iPad
To stream music stored on your iPhone, iPod touch or iPad directly to the MX122 perform the following:

5. Tap the AirPlay Icon on the iPhone, iPod touch or iPad. Refer to figure 36.

AirPlay icon

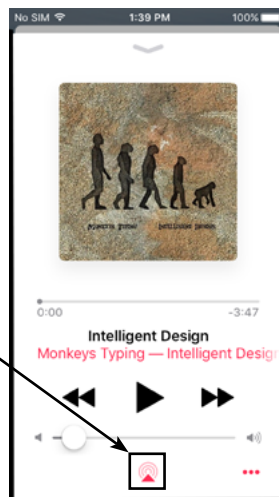

Figure 36

6. From the list appearing on the iPhone, iPod touch or iPad select McIntosh:[MX122]. Refer to figure 37.

Select MX122

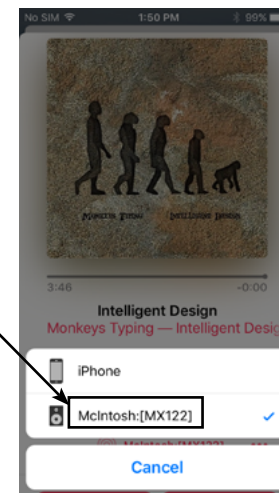

Figure 37

USB Drive Playback

Connect the USB Memory Device directly to the MX122 Rear Panel iPod/USB Connector. To playback music and still images from the USB Memory Device through the MX122 perform the following steps:

1. Rotate the INPUT Control on the Front Panel to select iPod/USB or press the iPod/USB Push-button on the Remote Control.
2. Use the Directional Push-buttons to select the desired music track or picture. Refer to figure 43.

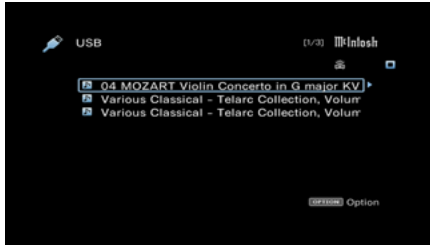

Figure 43

3. Press the ENTER Push-button to start playback of music or still image. Refer to figure 44.

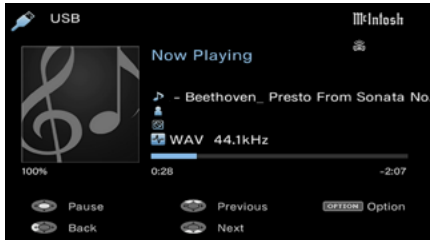

Figure 44

4. To change selection of the music track or still image, press the BACK Push-button and then perform steps 2 and 3 again.

When using the USB Memory Device the following are important things to keep in mind:

5. If the USB memory device is divided into multiple partitions, only the top partition can be selected.
6. The MX122 is compatible with MP3 files conforming to “MPEG-1 Audio Layer-3” standards.

7. Only USB memory devices conforming to mass storage class and MTP (Media Transfer Protocol) standards can be played on the MX122.
8. The MX122 is compatible with USB memory devices in “FAT16” or “FAT32” format.
9. The MX122 plays back image (JPEG) files in the orientation in which they are stored in the folder.
10. It is not possible to connect and use a computer via the USB port of this unit using a USB cable.

Compatible Formats	USB Memory Devices (A thru C)
WMA (Windows Media Audio)	Yes (D)
MP3 (MPEG-1 Audio Layer-3)	Yes
WAV	Yes
MPEG-4 AAC	Yes (E)
FLAC (Free Lossless Audio Codec)	Yes
JPEG	Yes
ALAC ¹	
DSD	
AIFF	

- A. This unit is compatible with MP3 ID3-Tag (Ver. 2) standard.
- B. This unit can show the artwork that was embedded by using MP3 ID3-Tag Ver. 2.3 or 2.4.
- C. This unit is compatible with WMA META tags. WAV format Quantization bit rate: 16 bits. FLAC format Quantization bit rate: 16/24 bits.
- D. Copyright-protected files can be played on certain portable players compatible with MTP.
- E. Only files that are not protected by copyright can be played on this unit. Content downloaded from pay sites on the Internet are copyright protected. Also, files encoded in WMA format when ripped from a CD, etc. on a computer may be copyright protected, depending on the computer's settings.

Compatible Formats	Sampling Frequency	Bit Rate	Extension
WMA (Windows Media Audio)	32Bit 44.1/48kHz	48-192 kbps	.wma
MP3 (MPEG-1 Audio Layer-3)	32Bit 44.1/48kHz	32-320 kbps	.wp3
WAV	32Bit 44.1/48kHz/88.2kHz/ 96kHz/176.4kHz/ 192kHz	-	.wav
MPEG-4 AAC	32Bit 44.1kHz/48kHz	16-320 kbps	.aac/ .m4a/ .mp4
FLAC (Free Lossless Audio Codec)	32Bit 44.1/48kHz/88.2kHz/ 96kHz/176.4kHz/ 192kHz	-	.flac
ALAC ¹	32Bit 44.1/48kHz/88.2kHz/ 96kHz	-	.m4a
DSD	2.8Mhz	-	.dsf/.dff
AIFF	32Bit 44.1/48kHz/88.2kHz/ 96kHz/176.4kHz/ 192kHz	-	.aif/.aiff

¹ The ALAC decoder is distributed under the Apache License, Version 2.0.

Internet Radio

The MX122 offers access to Internet Radio which is the streaming of music from Radio Broadcast Stations World Wide. For more information about this refer to sources such as http://en.wikipedia.org/wiki/Internet_radio via your computer or mobile device and a WEB Browser. To play music from Internet Radio through the MX122 perform the following steps:

1. Press the ONLINE MUSIC Push-button on the Remote Control and the Internet Radio On-Screen Menu will appear. Refer to figure 45.
2. Select "Local Stations" and after several moments a listing of local radio stations in your area will appear On-Screen. Refer to figure 46.
Note: The Station selected, WSKG 89.3 FM is located in the Binghamton, NY area.
3. Press the ENTER Push-button on the Remote Control and the MX122 will now access WSKG 89.3 FM. Refer to figure 47.
4. There are Internet Radio Stations that are accessible by selecting "Search Stations" and then "Location". Refer to figures 45 and 48. Follow the on screen menus to access the station(s) you desire.
5. The MX122 offers the ability to store in its memory up to 100 of your Favorite Stations for easy recall.
6. To save the current station into memory, press the OPTION Push-button and select "Save to Favorites" then press the ENTER Push-button. Refer to figure 49.
7. To remove a station from the Favorites press the ONLINE MUSIC Push-button. Highlight the "Favorites Icon", press the ENTER Push-button. Then select the station to remove and press the ENTER Push-button. Refer to figures 50 and 51.



Figure 45

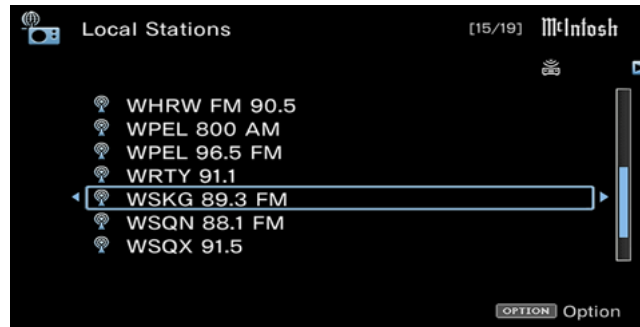

Figure 46



Figure 47

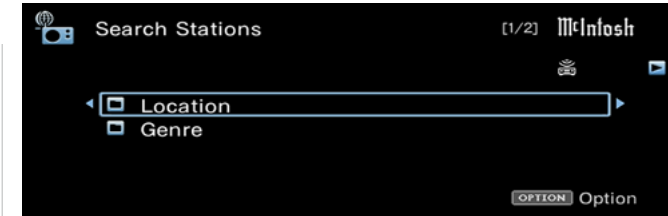

Figure 48

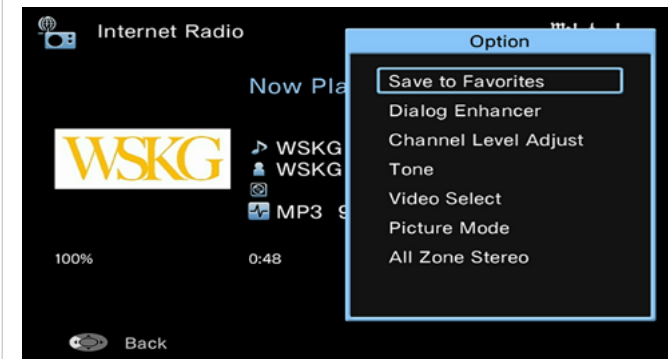

Figure 49



Figure 50



Figure 51

Special Internet Media Streaming

Your McIntosh MX122 has been factory pre-configured for accessing several Internet Media Streaming Sites. The pre-configured sites vary depending upon the location where the MX122 will be used. McIntosh's own special site (via vTuner) is available for all locations.

The Internet Sites provide Streaming Music via Internet Connection available thru the MX122. These usually require registration for access and some also require subscription fees. For additional information about PC Internet WEB Browser Programs, Computers, PC Network Connections and Settings, please refer to the documentation supplied with your computer and network hardware.

A computer is not needed for Media Streaming, however it is required to Register/Login In/Sign In for some Internet Media Streamers including McIntosh's own special site. In return for registering, the Internet Media Streamers usually provide easier use, access to other information or additional functions.

Before registering at the McIntosh (vTuner) Site, please look up the MAC Address (unique Identification Number [ID] for each MX122) as it will be entered in the "ID" field as part of the registering process. Refer to the "Introduction to the MX122 Setup Mode" for how to navigate thru the On-Screen Menu System on page 16 and "Network Setup Menu" on page 22. The following is the path to the MAC Address location:

1. Press the SETUP Push-button
2. Select menu item "Network"
3. Select menu item "Information"

The On-Screen Display Indicates the MAC Address.

Below is the URL Address for McIntosh (vTuner) and is accessible via your computer using an Internet Web Browser: <http://www.radiomcintosh.com>.

Provide the necessary information and spend a few minutes selecting the types of music you are interested in hearing and saving as your "Favorite". Refer to figures 52 and 53.

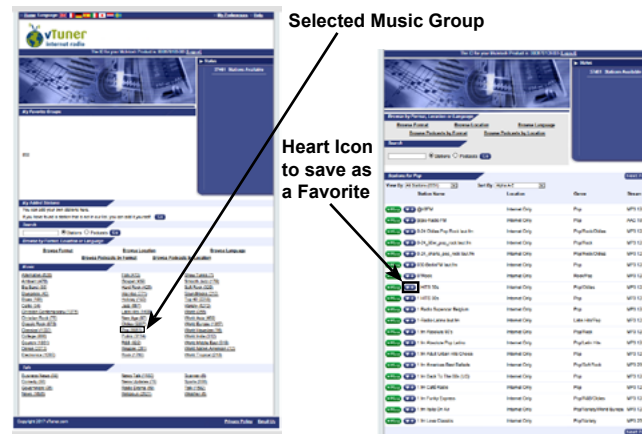

Figure 52

Figure 53

The McIntosh vTuner Site stores your selections and that information will now be available to the MX122 when accessing the Internet "Radio McIntosh" Site. Perform the following steps to access the Radio McIntosh Site:

1. Press the ONLINE MUSIC Push-button and then select "Internet Radio" followed by pressing the ENTER Push-button. Refer to figure 54.

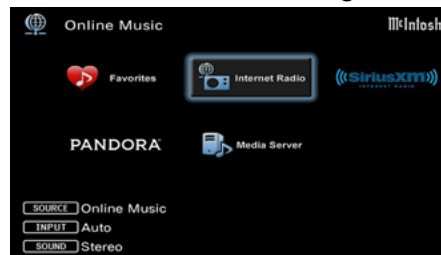

Figure 54



Figure 55

2. Select "radiomcintosh.com", followed by selecting "Favorites". Refer to figures 55, 56 and 57.

Note: After the initial Internet Radio Setup, the Internet Radio Menu can be accessed by pressing the BACK Push-button.



Figure 56



Figure 57

Pandora and other Internet Media Streaming Sites are accessed in a similar manner like the McIntosh vTuner Site. They require setting up an initial account, by using a computer with access to their WEB Site or by using the built-in MX122 Account Setup Feature.

On the next page is another example of an Internet Media Streaming Site which instead uses an Apple Mobile Device to stream music from the Media Streaming Site to the MX122 via WiFi.

Special Internet Media Streaming, con't

SPOTIFY

The Spotify Internet Media Streaming utilizes an Apple Mobile device for access to their music services. Follow the steps below to setup the MX122 to receive music from Spotify:

1. Using your Apple Mobile Device, establish a connection between the mobile device and your network router the MX122 is connected to.
2. Stream music from your Apple Mobile Device to the MX122 to verify proper wireless operation, if you have not already done so. Refer to page 38 for assistance in setting up "AirPlay".
3. Download the "Spotify Music App" from the Apple App Store using your Apple Mobile Device with direct Internet access or via the iTunes Computer Program with your Apple Mobile Device directly connected to the computer.
4. Using the Apple Mobile device, select the Spotify App Icon, refer to figure 58. Referring to figure 59, select the Spotify Icon.
5. Select "Account" from the Spotify Menu to set up an account for access to Spotify Music. Refer to figure 60.
6. Select "Devices" from the Spotify Menu and then select the "Devices Menu" Icon. Refer to figure 61.
7. From the "Connect to a device" list, select the MX122. Refer to figure 62.
8. From the "Your Library" menu list, select "Albums" and then the desired artist. Refer to figures 63 and 64.



Figure 58

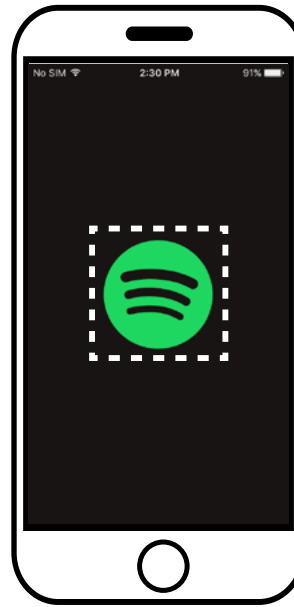

Figure 59

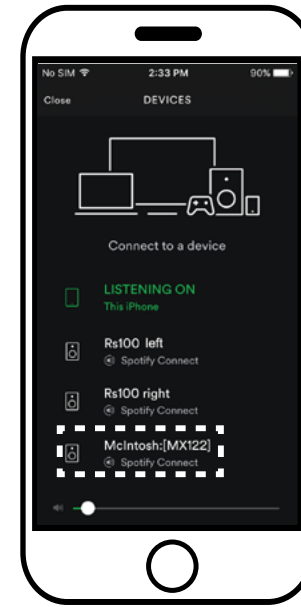

Figure 62

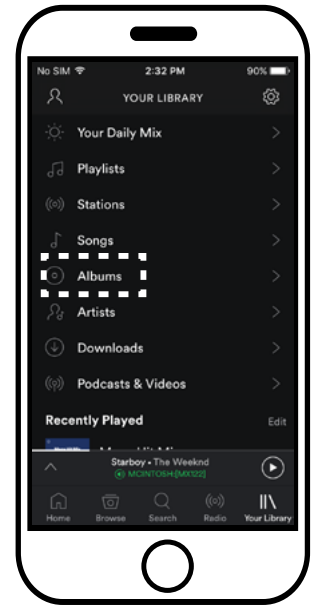

Figure 63

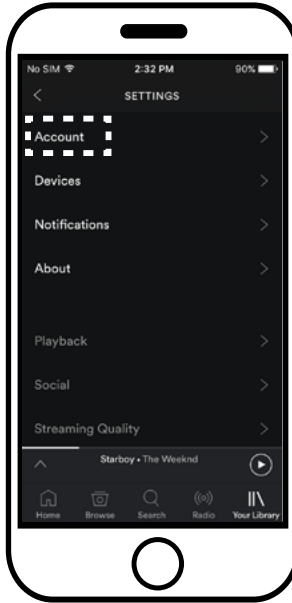

Figure 60

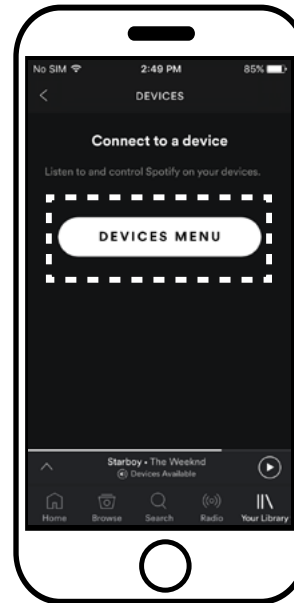

Figure 61

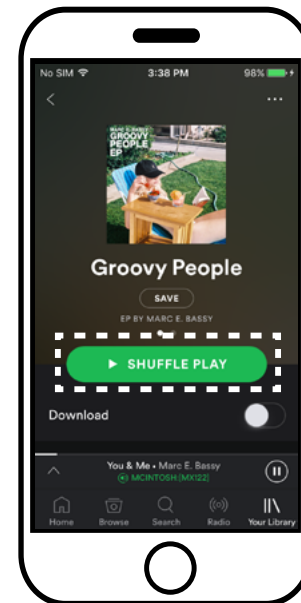

Figure 64

Media Server

The MX122 A/V Processor has the ability to access a PC Computer and/or a NAS (Network Attached Storage) unit for playback of digital music files and/or digital picture files. The PC Computer and the NAS unit need to be connected to the same Router/Network as the MX122. The NAS unit also needs to be compatible with the consumer electronics DLNA (Digital Living Network Alliance) Standard. Follow the steps below to access the music and/or pictures via the MX122:

1. Press the ONLINE MUSIC Push-button and then select "Media Server" from the On-Screen Selection Menu, followed by pressing the ENTER Push-button. Refer to figure 65.

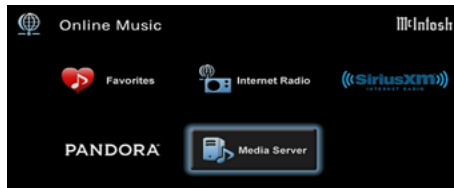

Figure 65

2. Use the ▼(Down) or ▲(Up) directional Push-button to highlight either "HOME COMPUTER" or "NAS NETWORK UNIT", followed by pressing the ENTER Push-button. Refer to figures 66 and 67.

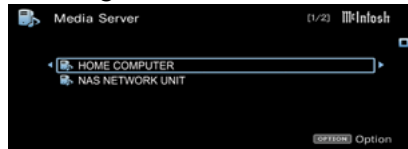

Figure 66

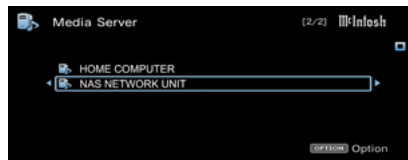

Figure 67

3. For music playback select "Music" from the appropriate Menu. Refer to figures 68 and 69.
4. Referring to figure 70, select a category of music.

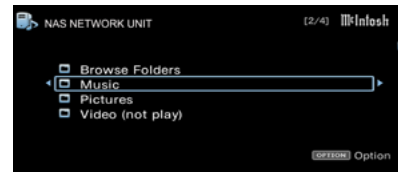

Figure 68

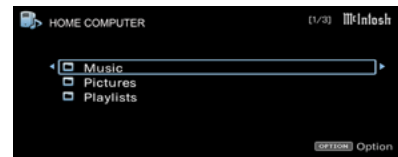

Figure 69



Figure 70

5. When the music starts playing figure 71 will appear On-Screen.
6. By pressing the Option Push-button, there are several music playback options. Refer to figure 72.

7. To view pictures Select from the menu "Pictures" in figure 73. Followed by selecting a category of pictures in figure 74.

Note: To return to a previous Menu or Menu Item, press the "BACK" Push-button.

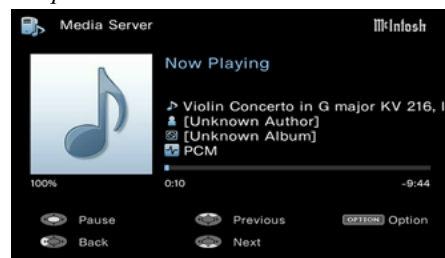

Figure 71

8. Select the desire image to view, refer to figures 75 and 76.
9. By pressing the Option Push-button and then selecting the "Picture Modes", there are several viewing picture options available. Refer to figure 77.

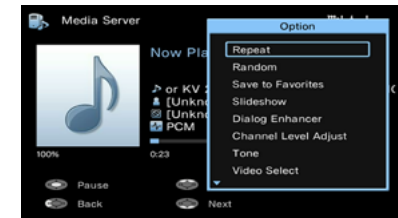

Figure 72

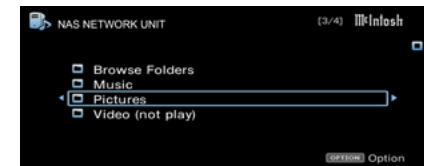

Figure 73



Figure 74

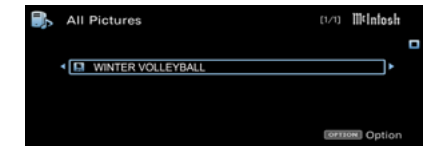

Figure 75



Figure 76

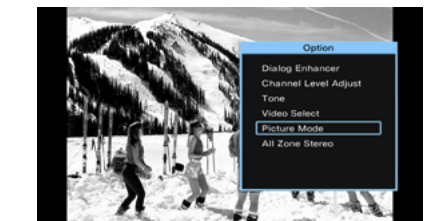

Figure 77



MX122 PC Guide

The MX122 A/V Processor has the ability to be remotely controlled by a PC running a Windows Internet WEB Browser Program. The PC needs to be connected to the same Router/Network as the MX122. Functions include access to the MX122 Setup Menu Items and settings, along with Operational Functions. Refer to figures 78 and 79. The PC's GUI (Graphical User Interface) together with a keyboard and mouse, allow for quicker navigation of Setup Menus, changing the Setup Menu Settings and operating the MX122.

An important function the computer permits is the creation of a PC File containing all the current MX122 Setup Settings Data, to be saved. Refer to figure 80. When necessary, all of the MX122 Setup Settings previously saved to the PC File, can be restored by reloading the data back into the MX122.

Refer to figure 81.

For additional information about PC Internet WEB Browser Programs, PC Network Connections and Settings, please refer to the documentation supplied with your computer and network hardware.

Note: Some Windows WEB Browsers might not respond properly with the MX122. If that occurs try another Windows Internet WEB Browser.

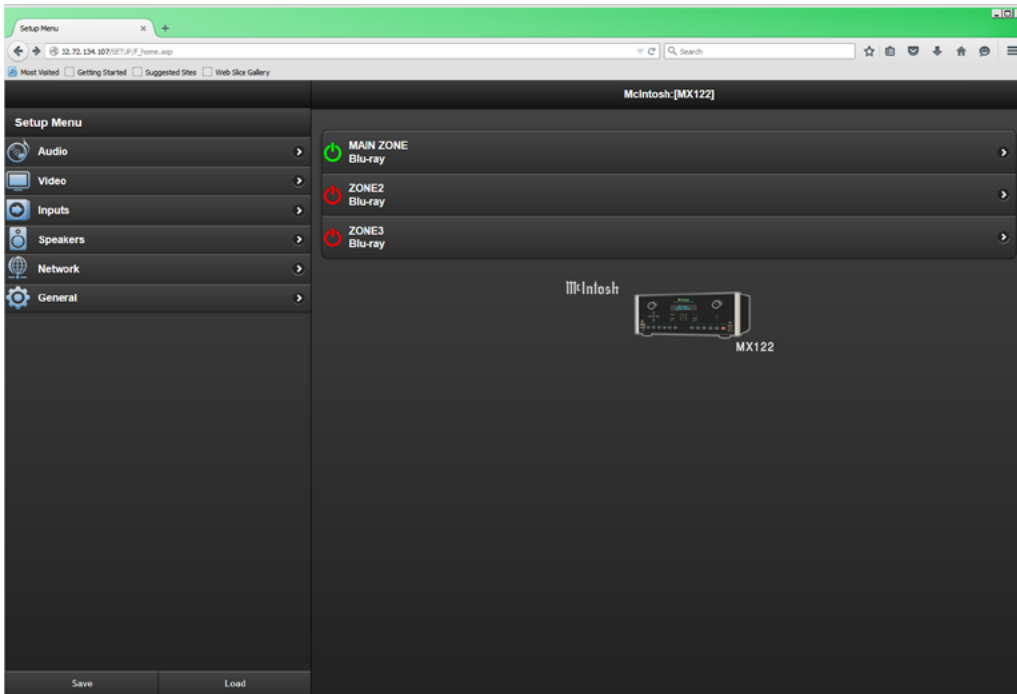

Figure 78

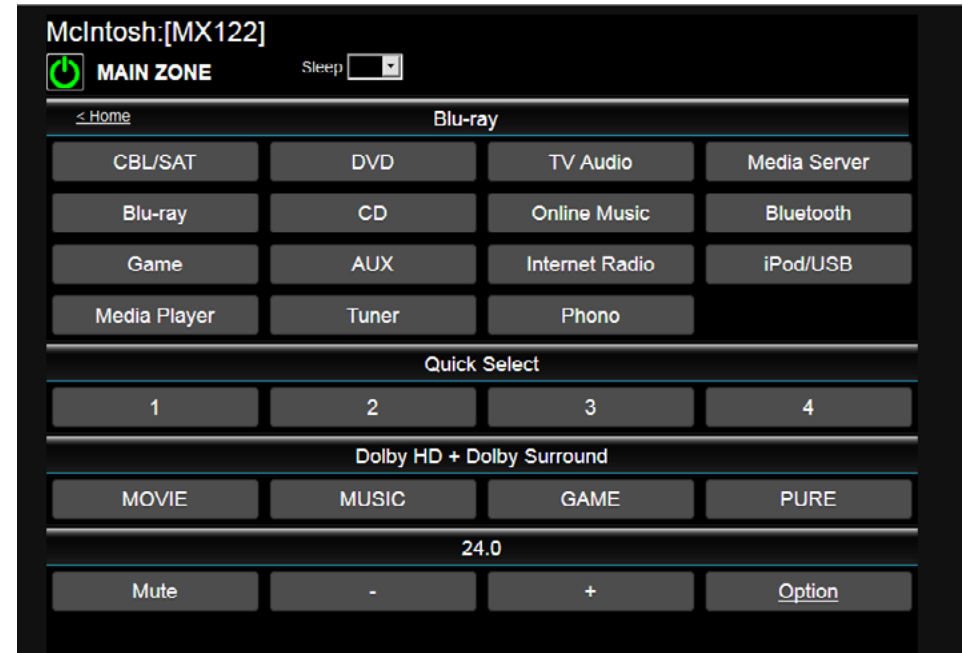

Figure 79

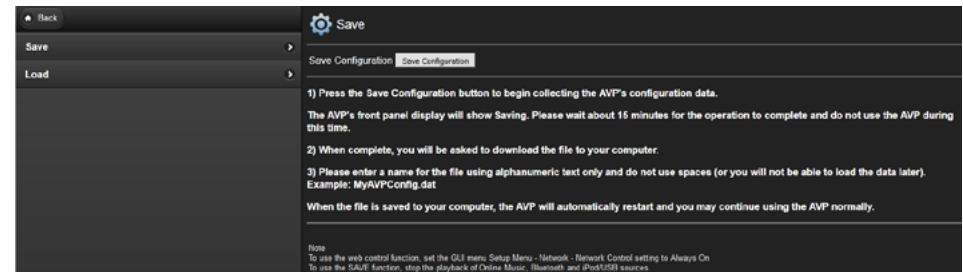

Figure 80

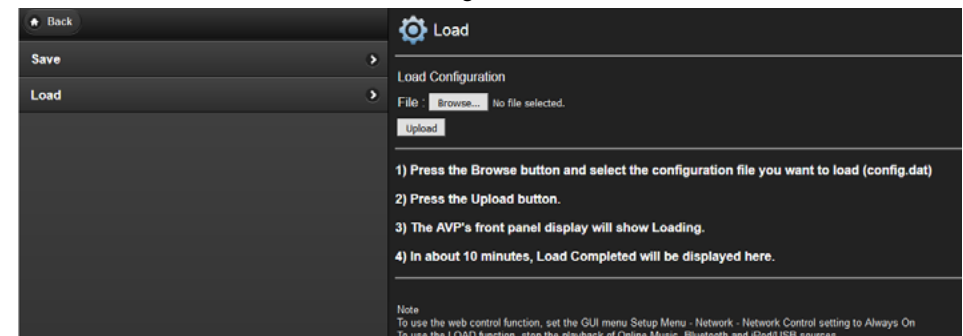

Figure 81

Resetting the Microprocessors

In the highly unlikely event the Controls and/or Push-buttons on the MX122 become non-response, it may become necessary to reset the microprocessors in the MX122. Perform the following steps to take corrective action:

REMOVE POWER:

1. Remove the AC Power Cord from the Rear Panel of the MX122.
2. Having waited at least 15 to 20 seconds after removing the AC Power Cord, reattach the AC Power Cord to the Rear Panel of the MX122.
3. Press the Front Panel STANDBY ON Push-button to switch Power ON to the MX122

Factory Default Settings

The following steps will return the MX122 to factory default settings:

1. Press the STANDBY ON Push-button to switch Power OFF to the MX122. Refer to figure 82.



Figure 82

2. When the unit is OFF, press and hold-in the "MOVIE" and "MUSIC" Front Panel Push-buttons, followed by pressing the STANDBY ON Push-button.
3. When the MX122 is powered ON and all the Front Panel Information Display Segments are illuminated, release the Front Panel Push-buttons "MOVIE" and "MUSIC".
4. Perform the steps in the MX122 Initial Setup Guide (separate instruction sheet).

5. If you previously stored all the MX122 User Setting to a PC file stored on your computer, now is the time to reload data into the MX122.





Audio Specifications

Unless otherwise noted, the below MX122 Specifications were taken with Audyssey bypassed.

Frequency Response

±0.5dB from 20Hz-20,000Hz

Total Harmonic Distortion

0.005% maximum from 20Hz to 20,000Hz at rated output

Signal To Noise Ratio

Phono: 86dB below 10mV input (A Weighted)
High Level: 96dB below rated output (A Weighted)

Rated Output Voltage

2.5V Unbalanced Outputs (Main Zone)
5.0V Balanced Outputs (Main Zone)

Maximum Voltage Output

6V Unbalanced
12V Balanced

Output Impedance

220 ohms

Input Impedance

Phono: 47k Ohms, 65pf
High Level: 20k Ohms Unbalanced and Balanced

Sensitivity for Rated Output

Phono: 4.5mV
High Level: 450mV Unbalanced
900mV Balanced

Maximum Input Signal

Phono: 50mV
High Level: 4.5V Unbalanced and Balanced

Audio Equalizer

Refer to Supplied Separate Sheet MX122 - MENU-2, Audio/Graphic EQ Illustration

Video Specifications

Signal System

NTSC/PAL

HDMI(Inputs and Outputs)

Version 2.0, High Dynamic Range (HDR), 4K Ultra HD@50/60Hz, 4:4:4 Color, Rec. 2020, 3D Video pass-through

HDCP

Version 2.2

Scaling

Analog and Digital Video Inputs scaled to a 4K Digital Signal

Component Video Output Level

Y Output Level 1.0Vp-p (75 OHM)
P_B/C_B Output Level 0.7Vp-p (75 OHM)
P_R/C_R Output Level 0.7Vp-p (75 OHM)

Composite Video Output Level

1Vp-p (75 OHM)

Wi-Fi & Bluetooth Specifications

Wireless LAN section

Radio Frequency: 2.4 GHz
No. of Channels: 1-11 CH (North America)
1-13 CH (Other country)

Bluetooth Section

Communications System: Bluetooth Version 2.1 + EDR (Enhanced Data Rate)

General Specifications

Power Requirements

Field AC Voltage conversion of the MX122 is not possible. The MX122 is factory configured for one of the following AC Voltages:

100 Volts, 50/60Hz at 75 watts
110 Volts, 50/60Hz at 75 watts
120 Volts, 50/60Hz at 75 watts
220 Volts, 50/60Hz at 75 watts
230 Volts, 50/60Hz at 75 watts
240 Volts, 50/60Hz at 75 watts
Standby, less than 0.5 watt

Note: Refer to the rear panel of the MX122 for the correct voltage.

Overall Dimensions

Width is 17-1/2 inches (44.45cm)
Height is 7-5/8 inches (19.37cm) including feet
Depth is 19-1/2 inches (49.53cm) including the Front Panel, Knobs, Rear Panel Connections and USB Drive

Weight

31 pounds (14Kg) net, 55 pounds (25Kg) in shipping carton

Shipping Carton Dimensions

Width is 25 inches (63.5cm)
Height is 18-3/8 inches (46.67cm)
Depth is 28 inches (71.12cm)

Packing Instructions

In the event it is necessary to repack the equipment for shipment, the equipment must be packed exactly as shown below. It is very important that the four plastic feet are attached to the bottom of the equipment.

This will ensure the proper equipment location on the bottom pad. Failure to do this will result in shipping damage.

Use the original shipping carton and interior parts only if they are all in good serviceable condition. If a shipping carton or any of the interior part(s) are needed, please call or write Customer Service Department of McIntosh Laboratory. Refer to page 4. Please see the Part List for the correct part numbers.

Quantity	Part Number	Description
1	034256	Shipping carton only
4	033887	End cap
2	034493	Spacer pad
1	033697	Inside carton only
1	033725	Inner carton top pad
1	034574	Bottom pad
2	034446	Foam plug
4	017937	Plastic foot
4	400159	#10-32 x 3/4" screw
4	404080	#10 Flat washer
1	034499	Accessory Box
1	034500	Slotted foam
1	034501	Divider foam

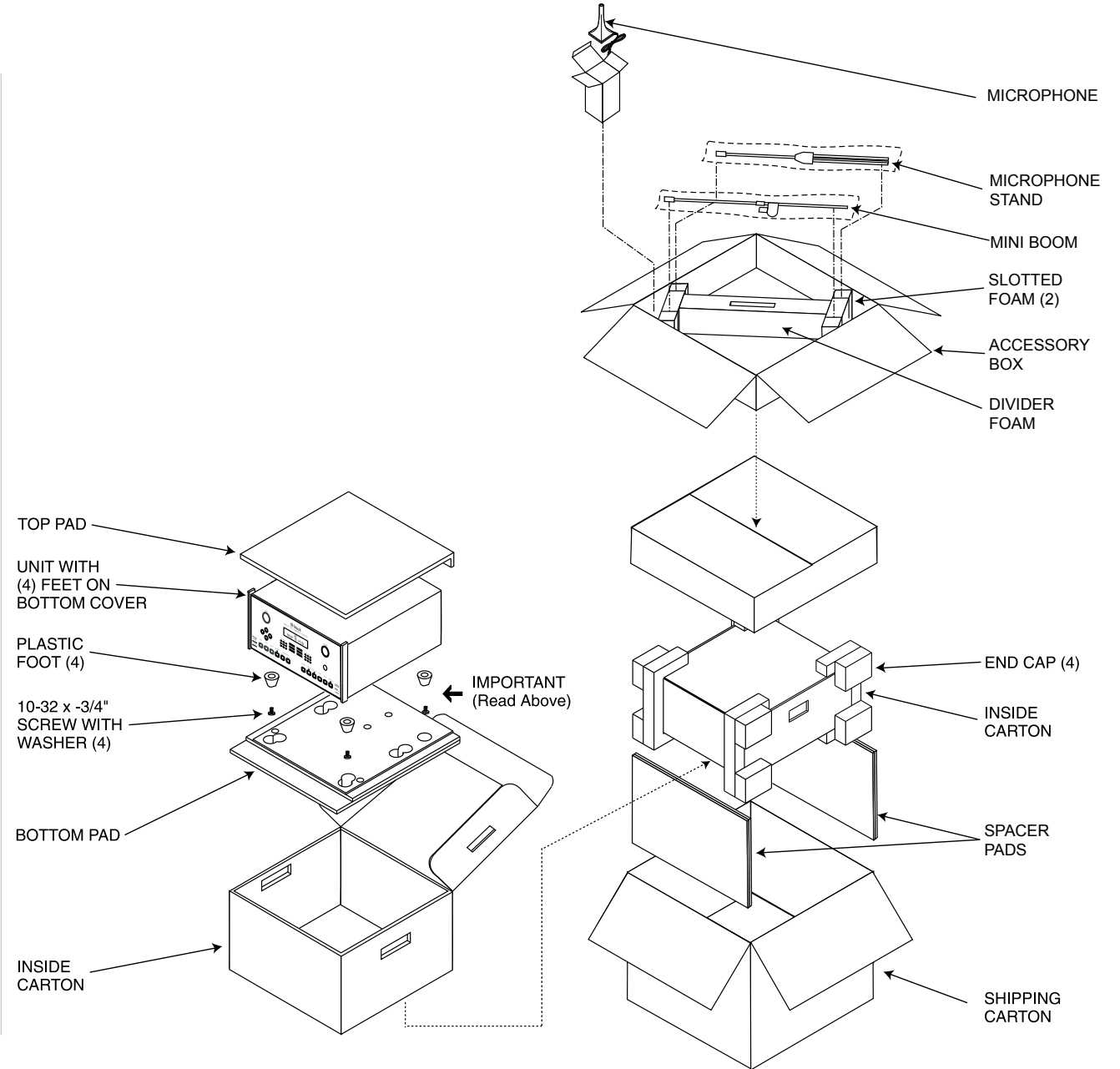



McIntosh Laboratory, Inc.
2 Chambers Street
Binghamton, NY 13903
www.mcintoshlabs.com

The continuous improvement of its products is the policy of McIntosh Laboratory Incorporated who reserve the right to improve design without notice. Printed in the U.S.A.

The MX122 is designed to employ non-McIntosh-provided services (including but not limited to Spotify, Pandora and SiriusXM), some of which require separate customer subscriptions and some of which do not, as part of the Products' functionality. Because McIntosh cannot control the providers of such services or the services themselves, the owner of the Product therefore assumes all risks related to the use of services provided by anyone other than McIntosh itself. McIntosh cannot and does not warrant against, and shall have no liability of any kind for any of the following that are attributable to non-McIntosh providers or services: (i) interruption, discontinuance, or other unsatisfactory performance of service; (ii) reduced Product functionality that is so attributable; or (iii) any other loss or damage of any kind that is so attributable.